

# SPECIFICATIONS



## TW030WA01 / TW030WA02, 30mm neodymium dome tweeter

TW030WA01 and TW030WA02 are high performance 30mm soft dome tweeters that work equally well for most demanding high frequency audio applications.

TW030WA01 is delivered without ferro fluid while TW030WA02 uses a light high-stability ferro fluid type.

The low resonance frequency and high power handling make TW030WA01 the ideal tweeter for 2-way speakers, where standard tweeters will not do.

The usage of dual neodymium magnets as power source ensures an almost perfect magnetic screening for demanding A/V applications.

The low distortion and the smooth and extended frequency response combine extreme details and dynamics into making TW030WA01/02 the pearl of any high-end 2-channel system.

Small size and high efficiency make TW030WA01/02 well suited for high quality multimedia applications.



### FEATURES

- Precision-coated textile diaphragm for improved consistency and high-frequency extension
- Vented voice coil former for reduced distortion and compression
- Copper-clad aluminium voice coil wire offering lower moving mass for improved efficiency and transient response
- Build-in cavities under dome/edge to equalize pressure for lower distortion and lower resonance frequency
- Rear heat sink for increased power handling and reduced power compression
- Dual neodymium magnets for improved efficiency and improved magnetic shielding for A/V applications
- Flexible lead wires for higher power handling and larger excursion
- Black anodized magnet structure for increased power handling and reduced power compression
- Gold plated terminals to prevent oxidation for long-term reliable connection
- Delivered with EVA gasket attached for hassle-free mounting and secure cabinet sealing

Parameter	Value, TW030WA01/TW030WA02	Unit
Nominal size	30	[mm]
Nominal impedance	4	[ohm]
Recommended freq. range	2-25	[kHz]
Sensitivity, 2.83V/1m, (average 2-20kHz)	94	[dB]
Voice coil diameter	30.4	[mm]
Voice coil height	1.7	[mm]
Air gap height	3.0	[mm]
Voice coil resistance, RDC	3.2	[ohm]
Voice coil inductance (measured at 20 kHz)	0.04	[mH]
Magnet weight (dual neo)	25.5	[g]
Effective radiating area, Sd	11.0	[sq.cm]
Power handling, continuous, IEC 268-5, 2.5kHz@12dB/oct.	30 / 35	[W]
Resonance freq., Fs	1,000 / 1,050	[Hz]
Moving mass, incl. air	0.43 / 0.49	[g]
Force factor, Bxl	2.33 / 2.55	[Tm]
Mechanical Q, Qm	4.7 / 1.24	-
Electrical Q, Qe	1.59 / 1.60	-
Total Q, Qt	1.19 / 0.70	-
Suspension compliance, Cms	0.059 / 0.045	[mm/N]
Equiv. air volume, Vas	0.010 / 0.0077	[lit.]
Total unit net weight	130	[g]

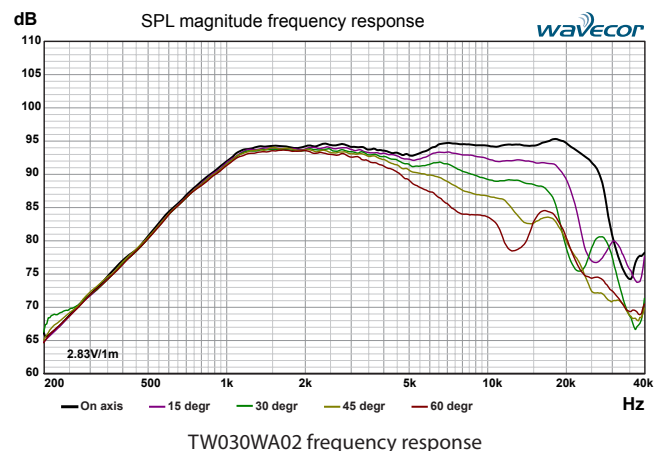
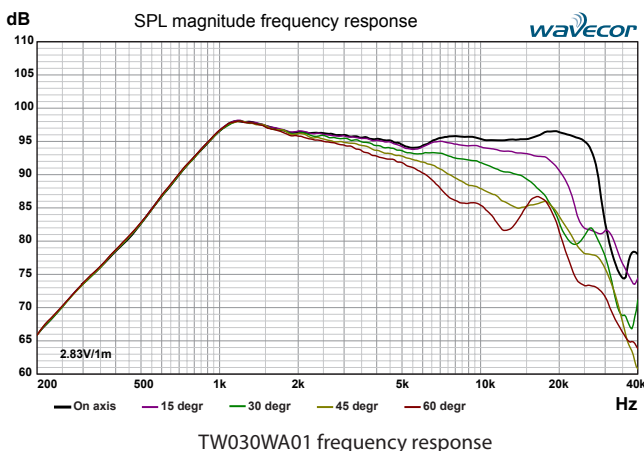

# SPECIFICATIONS



## TW030WA01 / TW030WA02, 30mm neodymium dome tweeter

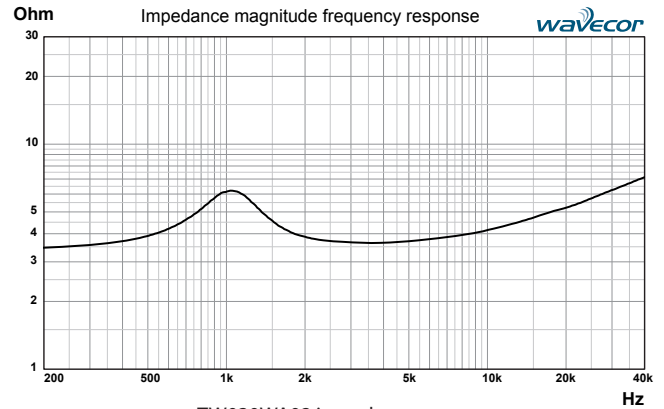
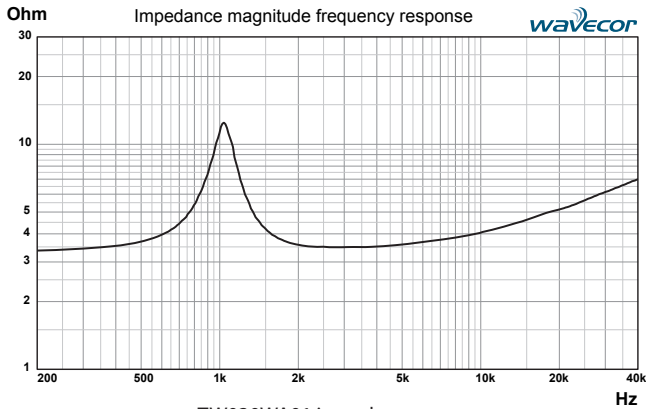

### OUTLINE DRAWING (dimensions in mm)

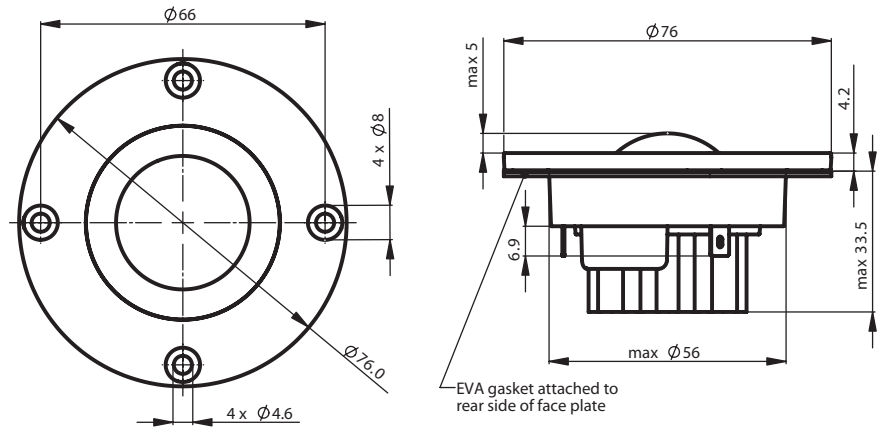

### CONNECTIONS

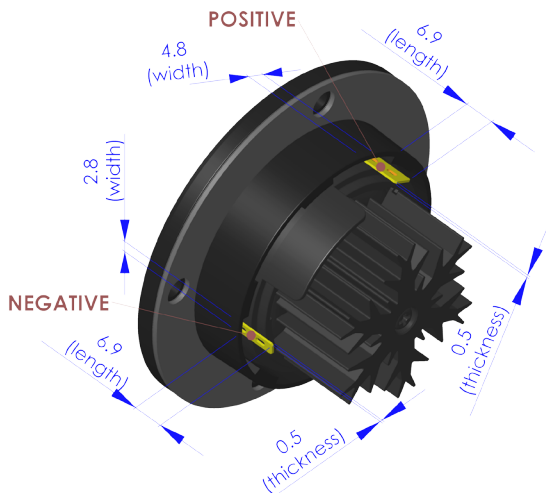

### CROSS SECTION

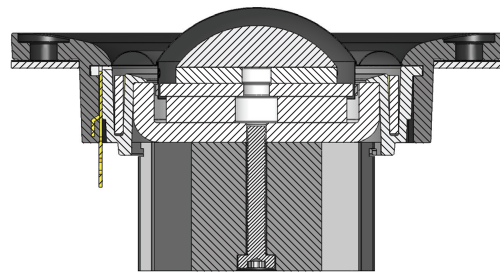

### PACKAGING INFORMATION

TW030WA01-01	Non-ferro fluid, one pair per box
TW030WA01-01	Non-ferro fluid, bulk packaging
TW030WA02-01	Ferro fluid, one pair per box
TW030WA02-01	Ferro fluid, bulk packaging

Latest update: May 14, 2011

Specifications are subject to change without any further notice. Copyright © 2006-2011 by Wavecor Ltd., Guangzhou, China. All rights reserved.  
Wavecor® is a registered trademark of Wavecor Ltd.

For more information please visit [www.Wavecor.com](http://www.Wavecor.com)