

# M 300

Art. No. 6056

---



**120°** Exponentialhorn für die Kombination mit dem 1"-Treiber DR 45 N - 8 Ohm (Art. No. 6060). Das M 300 ist ein aus MDF gefertigtes Holzhorn in höchster Verarbeitungsqualität, lackierbar in verschiedenen Farbtönen und somit für den Profi-PA- und Disco-Einsatz geeignet ist.

**120° exponential horn** in conjunction with the 1" driver DR 45 N - 8 Ohm (Art. No. 6060). The M 300 is a horn made of MDF, manufactured with highest workmanship, designed for spray-painting in any color and therefore especially suited for professional PA and disco applications.

11.12.2013

# M 300

Art. No. 6056

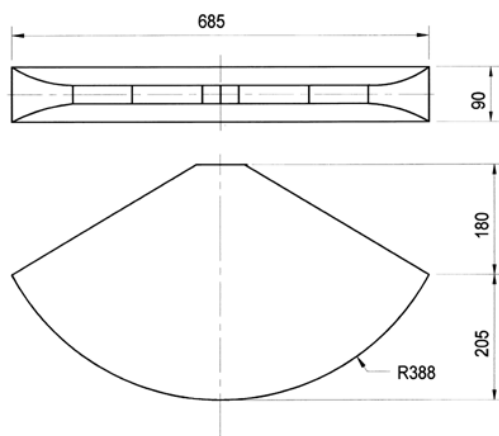

Technische Daten / Technical data

Abstrahlwinkel (-6 dB) 107°/4000 Hz hor.  
Opening angle (-6 dB) 71°/4000 Hz vert.

Gewicht netto 6,4 kg  
Net weight

