



BASS GUITAR AMPLIFIERS
MANUAL

SL *silver line*

SLT *silver line*



DESIGNED BY MUSICIANS FOR MUSICIANS

1**INTRODUCTION**

All the Taurus "SL" and "SLT" Silver Line amps are based on the same construction. The combos vary only in speaker systems, dimensions and weight. SLT series has a tube preamp and SL series has a tube simulation device. The amplifiers offer great dynamics and effectivity of bass reproduction resulting in a very selective sound. SICA neodyme speakers were applied for even higher quality. You can choose between two preamps: transistor and tube or tube simulation in "TL" series. The transistor preamp ensures great dynamics while the tube simulation one gives a warm, soft tube sound. Both preamps can be steplessly mixed offering the whole spectrum of desired sounds from crisp and clear to slightly overdriven tube. There is also a very effective and easy to operate **MLO-system** tone control to find the right sound quickly. The special design of the tone control enables revealing the character of the particular instrument meeting its both technical and musical parameters. The bass sound can be very low but still impressively selective. Unique high quality OPTICAL LIMITER is built-in for fast and noiseless operation.

2**MLO-system** Middle-range Level Optimization

*In TAURUS amplifiers designed by Box Electronics unique **MLO-system** equalization control has been applied to achieve easy and intuitional sound tailoring through only two Bass and Treble knobs. This type of sound correction makes it easy and fast to find the right tone colour. Characteristics of the tone settings are designed to meet the parameters of the instruments both technically and musically. In regular solutions one can practically use only 50% of the bass and treble correction range. The deeper correction usually results with loss of sound control. To make the best use of the 2 point correction it has been automatically coupled with midrange control. This solution provides optimal sound control especially in the adjacent mid and low frequencies and allows to use the whole range of the potentiometers for full spectrum of sound shape. Additionally the **MLO-system** results in same level volume output no matter how the low frequency control knob is positioned (no need for tricky correction of both bass and volume to keep the same loudness level). This lets the musician concentrate on the precise sound colour quality control only without any "too many knobs to operate" confusion.*

3**MAIN FEATURES**

- Power output: 300W RMS / 4ohm, 200W RMS / 8ohm,
- Loudspeakers configuration:
 - **SL/SLT-10** - BASS 1x10" neodymium + switchable dynamic tweeter [8ohm speaker inside]
 - **SL/SLT-1010** - BASS 2x10" neodymium + switchable dynamic tweeter [4ohm speaker inside]
 - **SL/SLT-12** - BASS 1x12" neodymium + switchable dynamic tweeter [4ohm speaker inside]
 - **SL/SLT-15** - BASS 1x15" neodymium + switchable dynamic tweeter [4ohm speaker inside]
- 2 preamps - transistor and tube with mixing [tube simulation in SL-series]
- Inputs: active and passive
- **GAIN** control
- Preamp **PEAK** indicator
- **TONE**:
 - **BASS** and **TREBLE** with **MLO** system
 - **PARAMETRIC EQUALIZER** for precise middle-tone control
 - **PUNCH** and **PRESENCE** shaping sound in middle and treble tones
 - **DBS** (Dynamic Bass System) - increases dynamics and selectivity of bass sound
 - **Studio quality optocoupler COMPRESSOR/LIMITER** with level control and ON/OFF switch
- **VOLUME** control
- **MUTE** switch
- Serial and parallel configuration effect loop
- Outputs: XLR balanced LINE output with PRE/POST selector and ground lift, Tuner, Loudspeakers, Phones
- Protections: Short circuit, thermal overload, power overload
- **CLIP** power amp indicator
- Forced cooling system with electronic efficiency control
- Dimensions/Weight:
 - **SL/SLT-10** [H x W x D]: 465 x 505 x 385mm / 22,6 kg/22,8kg
 - **SL/SLT-1010** [H x W x D]: 670 x 505 x 385mm / 33,5 kg/33,7kg
 - **SL/SLT-12** [H x W x D]: 540 x 505 x 385mm / 24,7kg/24,9kg
 - **SL/SLT-15** [H x W x D]: 670 x 505 x 385mm / 33,6 kg/33,8kg

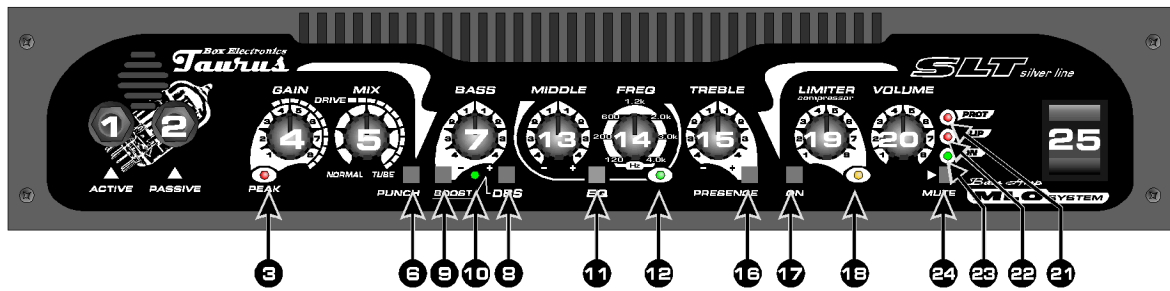

- [1] - Active bass instrument INPUT [JACK 6.3mm].
- [2] - Passive bass instrument INPUT [JACK 6.3mm].
- [3] - PEAK indicator in preamp section.
- [4] - GAIN control
- [5] - INPUT MIX - fluent signal adjustment of the input between 2 sections of the amplifier - transistor and tube [tube simulation in SL-series].
- [6] - PUNCH button - increases sonic expression.
- [7] - BASS control with MLO-system.
- [8] - DBS (Dynamic Bass System) - increases dynamics and selectivity of bass sound.
- [9] - DBS BOOST.
- [10] - DBS ON/BOOST indicator.
- [11] - PARAMETRIC EQ on/off switch.
- [12] - PARAMETRIC EQ indicator.
- [13] - PARAMETRIC EQ level control.
- [14] - PARAMETRIC EQ frequency adjustment (120Hz...4kHz).
- [15] - TREBLE CONTROL with MLO-system.
- [16] - PRESENCE button - increases transparency of sound.
- [17] - LIMITER-COMPRESSOR on/off switch.
- [18] - LIMITER indicator.
- [19] - COMPRESSION level adjustment.
- [20] - VOLUME control.
- [21] - PROTECTION indicator.
- [22] - Power amplifier CLIP indicator.
- [23] - ON/MUTE indicator.
- [24] - MUTE on/off switch.
- [25] - POWER on/off switch.

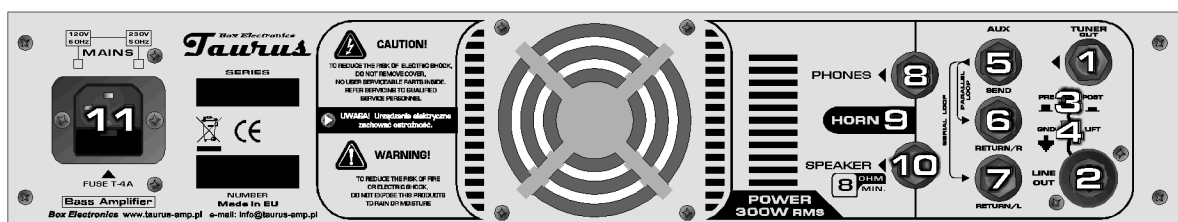

- [1] - TUNER OUTPUT [JACK 6.3mm].
- [2] - Balanced LINE OUTPUT [XLR].
- [3] - LINE OUTPUT PRE/POST EQ switch.
- [4] - LINE OUTPUT GROUND LIFT switch.
- [5] - AUX SEND output [JACK 6.3mm].
- [6] - AUX RETURN input [JACK 6.3mm] - PARALLEL LOOP.
- [7] - AUX RETURN input [JACK 6.3mm] - SERIAL LOOP.
- [8] - HEADPHONE output [JACK 6.3mm].
- [9] - HORN on/off switch.
- [10] - output for additional speaker cabinet. Additional cabinet connection, doesn't disconnect main combo speaker(s). Connection configuration is shown in p. 11, recommended speakers cabinet for each amplifier model are listed below:
SL/SLT-10: min. load of additional speaker cabinet 8 ohms and 200W, [parallel connection with the main speaker / set = 4ohm]
SL/SLT-12: min. load of additional speaker cabinet 4 ohms and 200W, [serial connection with the main speaker / set = 8ohm]
SL/SLT-15: min. load of additional speaker cabinet 4 ohms and 200W, [serial connection with the main speaker / set = 8ohm]
SL/SLT-1010: min. load of additional speaker cabinet 4 ohms and 200W, [serial connection with the main speaker / set = 8ohm]
- [11] - IEC POWER INPUT socket with AC fuse T-4A/230V, [T-6A/120V].

IMPORTANT NOTE: Always use slow blow or time delay type fuses. Do not use fast blow fuses.

- A** Set controllers and switches on the front panel in following positions:
- tone color controllers - BASS, MIDDLE, FREQ and TREBLE - in position "0",
 - remaining controllers in maximum left position,
 - all mode switches in turned off position.
- B** Set HORN switch on the back panel as you wish.
- C** Connect your bass guitar to appropriate input in the amplifier (ACTIVE or PASSIVE), and then switch on the power.

Basic elements that make up the character of desired sound are tone color and its dynamism. Section composed of controllers BASS, TREBLE, PARAMETRIC EQUALIZER as well as switches PUNCH, DBS and PRESENCE is responsible for tone color. In turn, controllers GAIN and COMPRESSOR/LIMITER, are responsible for tone dynamics. Controller MIX changes both the tone color and dynamics. Before setting about adjusting ones own tone, one ought to set controllers in positions determined in point 6A. Firstly set tone color using only BASS and TREBLE controllers and DBS and PRESENCE switches. In case when the adjustment is insufficient, use PARAMETRIC EQUALIZER, MIX adjustment or PUNCH switch.

► FIRST USING TIPS

- A** Set VOLUME controller in optimum and then set appropriate input sensitivity by using GAIN controller. GAIN controller should be set in a way that ensures to control the amplifier on required level. It is necessary to remember not to allow to overload the preamplifier while hard hitting the strings. The overload is indicated with PEAK indicator [3].
- B** Set the MIX controller in NORMAL position and go to tone control. Begin with adjusting BASS and TREBLE controllers. If you need stronger bass tone saturation switch on DBS-ON button, if you need much more bass tone, additionally switch on BOOST button. If you need to brighten the tone color, switch on PRESENCE button.
- C** PARAMETRIC EQUALIZER and MIX adjustment with PUNCH switch give more advanced tone control.
- Using equalizer you can precisely correct mid tones color. PARAMETRIC EQUALIZER is composed of 2 controllers - MIDDLE and FREQUENCY. One of controllers [MIDDLE] is designed for mid tones level adjustment. Using of the other controller [FREQUENCY] you can select appropriate mid tones range that you want to adjust. MIDDLE controller decides whether we want to amplify or cut out selected tone range. Setting MIDDLE controller in position "0" does not make any changes. Available adjustment range is set between 120Hz and 4kHz. You can switch on and off the equalizer using ON [11] button.
 - By using MIX controller you can change the tone character balancing between transistor and tube or tube simulation pre-amplifiers. Setting MIX potentiometer in NORMAL position assures dynamic and hard tone provided by transistor pre-amplifier. In TUBE position you will obtain characteristic warm and soft tone provided by lamp pre-amplifier. Depending on the MIX controller status the tone color of both channels is mixed together. If you want to get a little bit dirty and compressed sound that is provided by lamp pre-amplifier, you need to boost input sensitivity with use of GAIN controller. On the GAIN and MIX controllers' scale, the range you can obtain DRIVE typical for the tube, is marked with gapped line. If you want to set hard DRIVE, just increase GAIN controller while setting MIX position on right. It will sounds better if you turn off the HORN.
 - If you desire your bass tone be more exposed you can add more expression by using PUNCH switch [6] that causes the amplification the tone color in the range of "hard middle".
- D** If you have already set appropriate tone color of the instrument you can go to tone dynamism adjustment. High quality optical COMPRESSOR/LIMITER is at you disposal. The handling is very simple, you only need to switch on the ON [17] button and then while playing you set the level controller [19] in the appropriate position. Limiter action is indicated by LED [18].
- If you want to use limiter in order to secure against changing the power grade while loud and dynamic play, set the controller [19] in such position not to let the CLIP LED [22] to light on that indicates exceeding of maximum power amplifier level.
 - If you want to obtain appropriate tone compression, you should to increase limiter sensitivity by adjusting the controller [19] to the right. The sound compression can be enlarged even more by increasing sensitivity in the input of pre-amplifier with use of GAIN controller.
- E** In order to enrich the instrument sound you can use additional sound effects, external effects' loop AUX is designed for that, see point 9.

The amplifier is equipped with automatic power amplifier protecting systems. Activating the protection is noticed with PROT indicator located on the front panel of the amplifier. In case when the indicator is on permanently, then the loudspeakers are going to be disconnected. Inactivating of protection systems should be performed by turning off and on the amplifier. If the amplifier does not return to normal action, it means that the anti-overload or anti-short circuit system has been activated. In such case it is necessary to check loudspeakers impedance (it may be too low) and amplifier-loudspeakers connection (there may be short circuit). If the PROT indicator is still on, check the amplifier temperature (it may be too high). In this case just wait few minutes to amplifier cooling.

- In order to protect the loudspeakers avoid power amplifier overload. Power amplifier overload is indicated with CLIP LED located in the front panel of the amplifier. CLIP LED can flash under influence of strong sound impulses, however it is not recommended to set the amplifier in a way that the CLIP LED flashes very often.
- The amplifier should be placed in a spot that enables free air circulation for the cooling system to work properly.
- The amplifier should be used away from a heat sources.
- Protect the amplifier against moisture.
- A perfusion of the amplifier may cause damage or electric shock.
- Never try to repair the amplifier personally.
- Use fuses of parameters recommended by the producer only.

9 SOUND EFFECTS TO AMPLIFIER CONNECTION

Connection to PARALLEL MONO LOOP

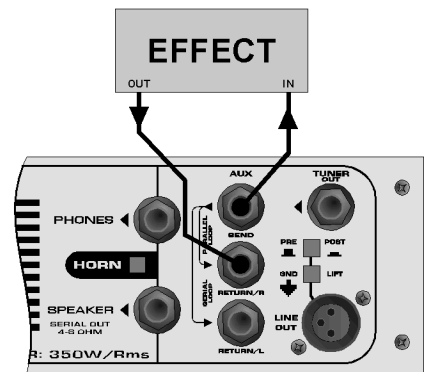
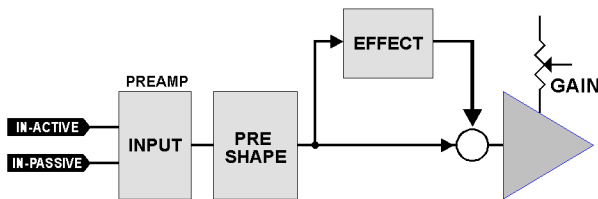

Connection to SERIAL MONO LOOP

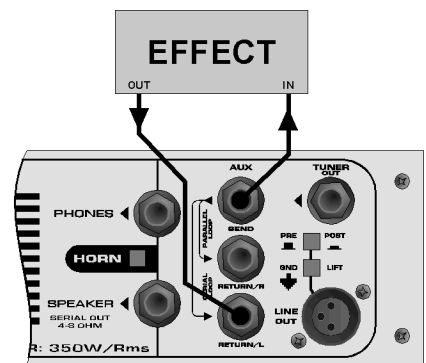
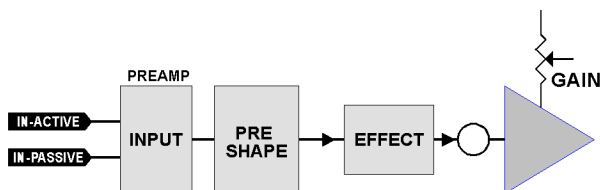

Connection to SERIAL STEREO LOOP

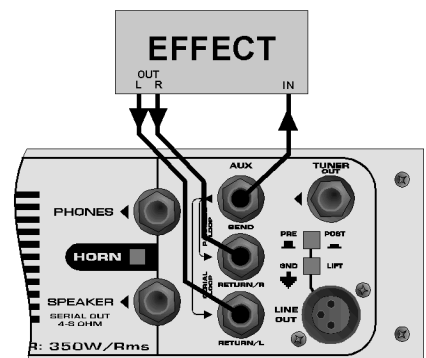
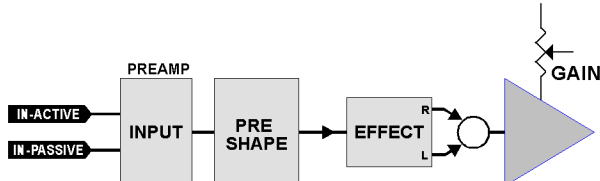

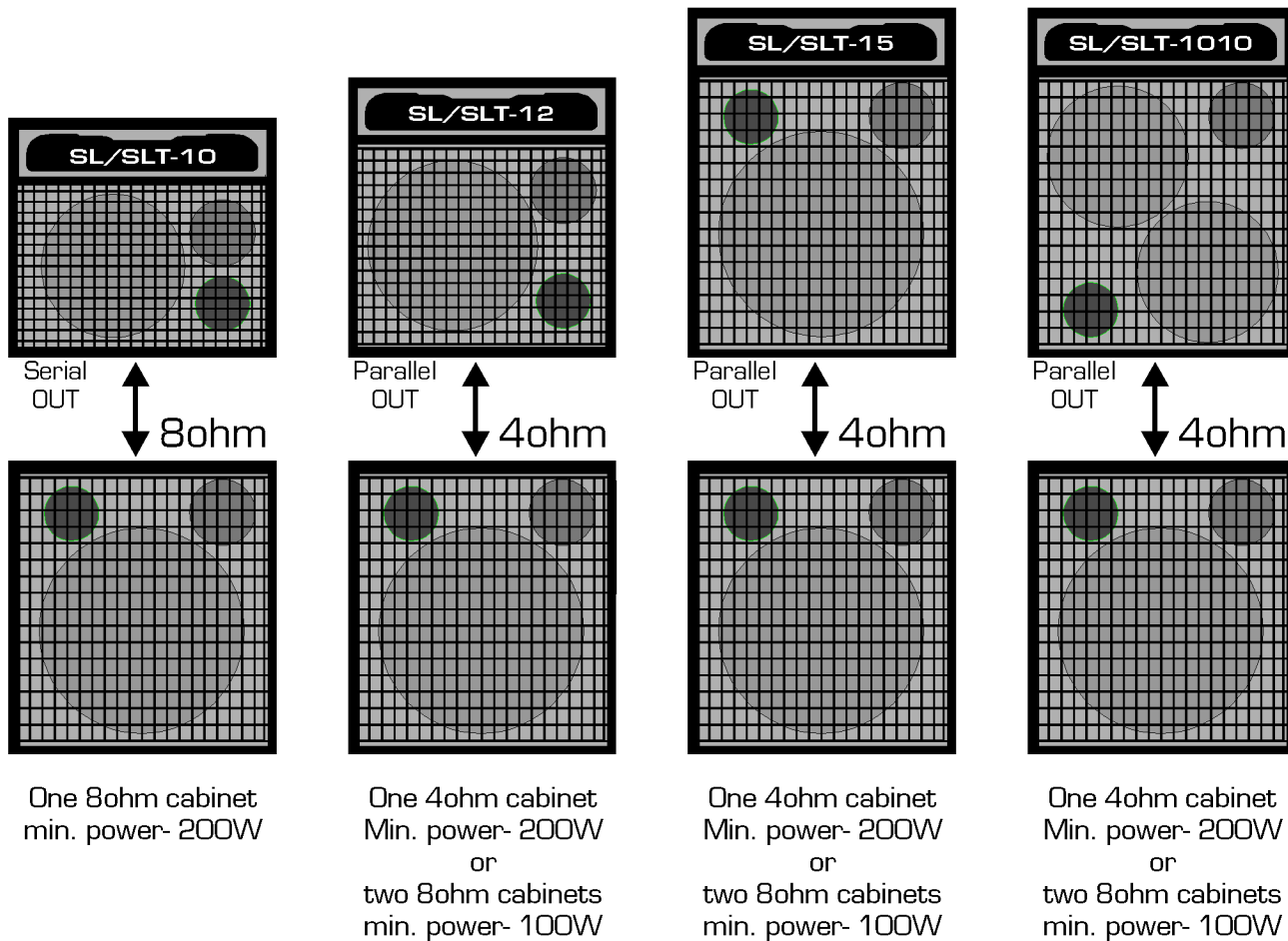
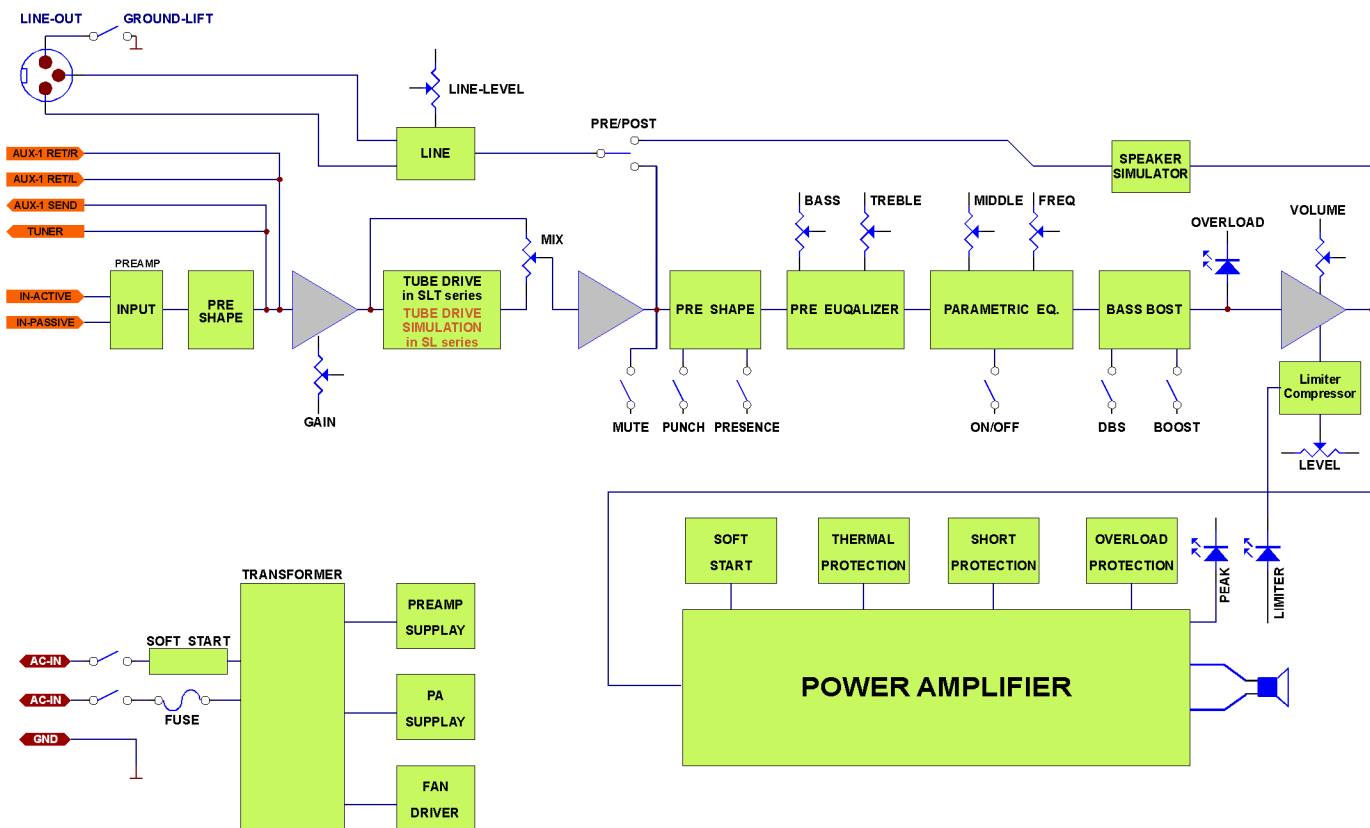

CE RoHS



Disposal of old Electrical & Electronic Equipment (Applicable throughout the European Union and other European countries with separate collection programs)

This symbol, found on your product or on its packaging, indicates that this product should not be treated as household waste when you wish to dispose of it. Instead, it should be handed over to an applicable collection point for the recycling of electrical and electronic equipment. By ensuring this product is disposed of correctly, you will help prevent potential negative consequences to the environment and human health, which could otherwise be caused by inappropriate disposal of this product. The recycling of materials will help to conserve natural resources. For more detailed information about the recycling of this product, please contact your local city office, household waste disposal service or the retail store where you purchased this product.

Taurus

www.taurus-amp.pl
info@taurus-amp.pl

Box Electronics ul. Cieszyńskiego 4
81-881 Sopot, POLAND
tel./fax +48 (058) 550 66 46, 551 90 05