

Level the mount and mark.

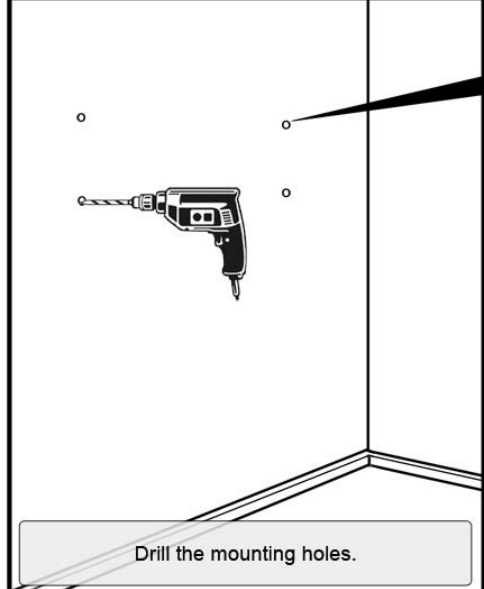

Drill the mounting holes.

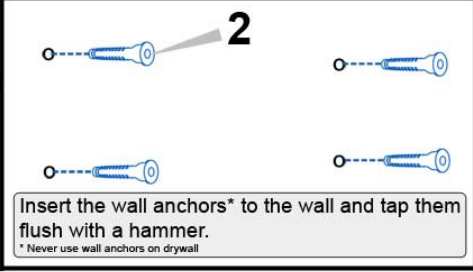

Insert the wall anchors* to the wall and tap them flush with a hammer.
* Never use wall anchors on drywall

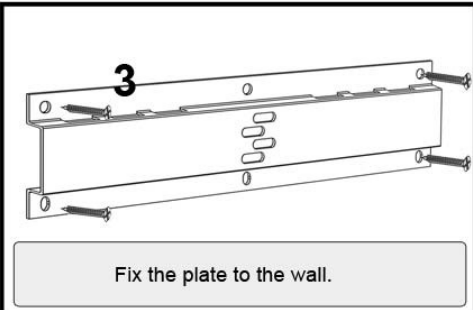

Fix the plate to the wall.

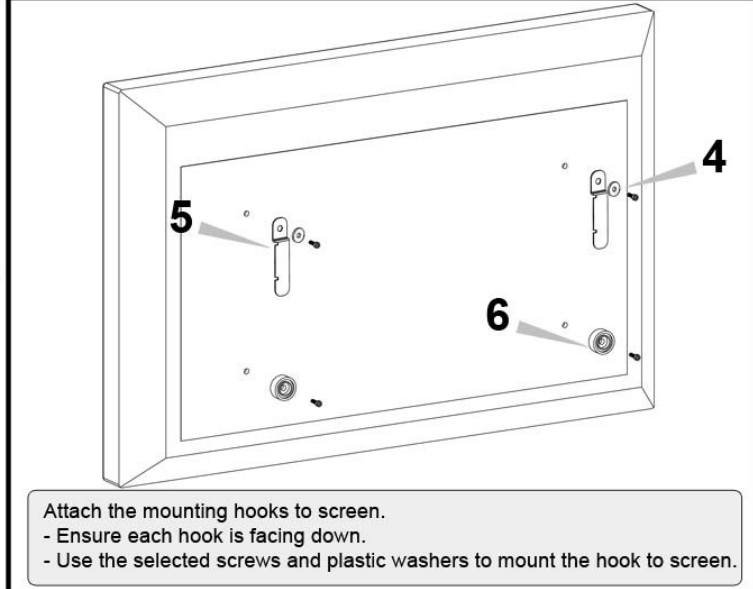

Attach the mounting hooks to screen.
 - Ensure each hook is facing down.
 - Use the selected screws and plastic washers to mount the hook to screen.

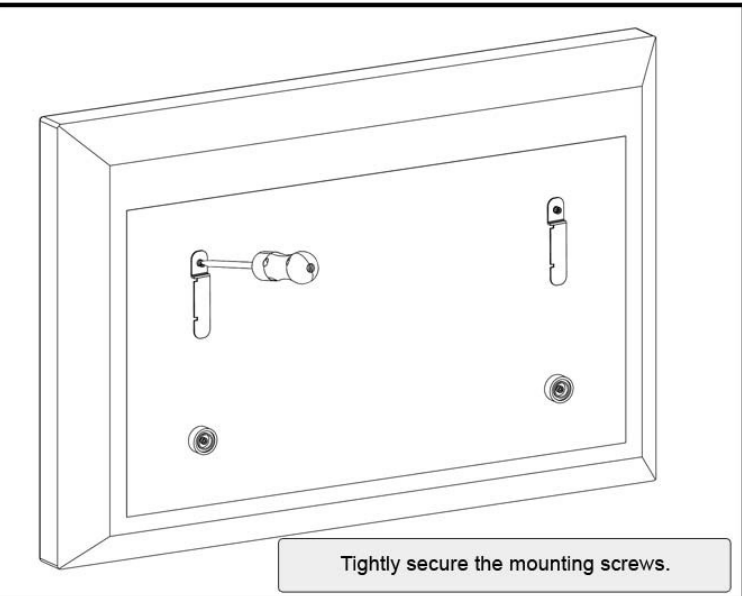

Tightly secure the mounting screws.

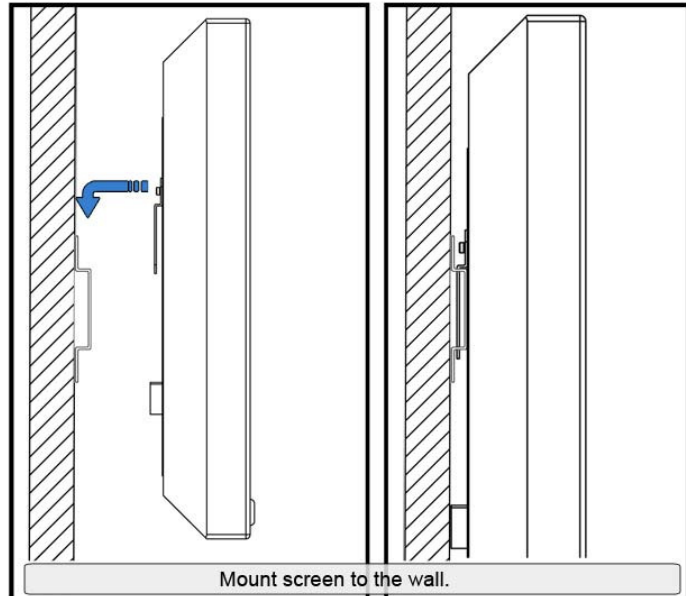

Mount screen to the wall.

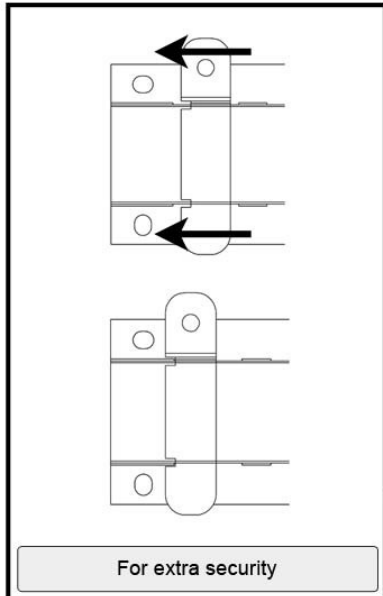

For extra security

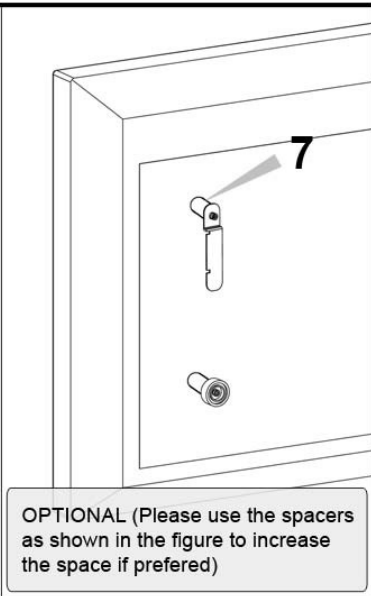

OPTIONAL (Please use the spacers as shown in the figure to increase the space if preferred)

