

1

Level the mount and mark.

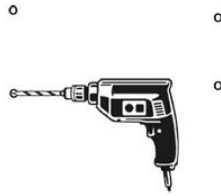

Drill the mounting holes.

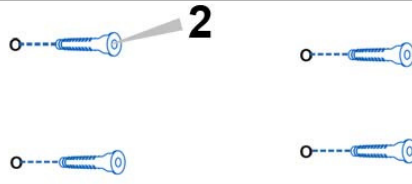

2

Insert the wall anchors\* to the wall and tap them flush with a hammer.

\* Never use wall anchors on drywall

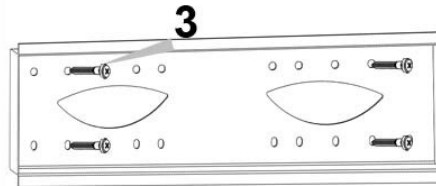

3

Fix the plate to the wall.

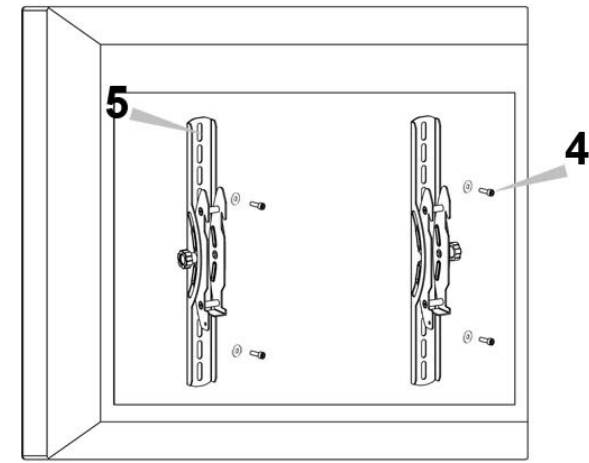

5

4

Attach the mounting rails to screen.

- Ensure that each rail mounting slot is facing down.
- Use the selected screws and washers to mount the rail to screen.

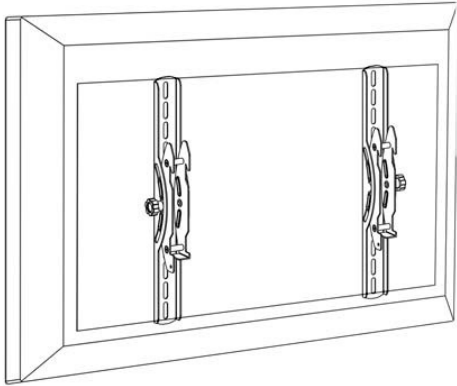

Tightly secure the mounting screws.

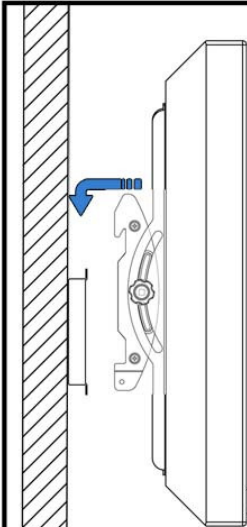
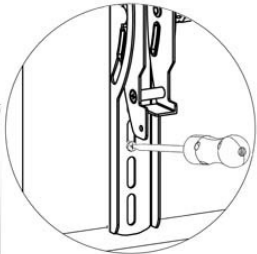

Mount screen to the wall.

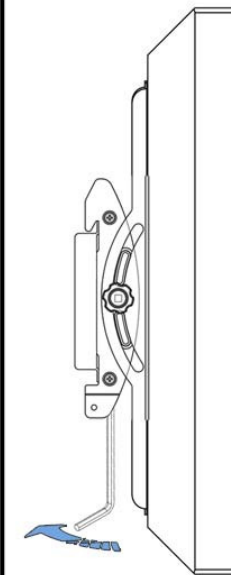
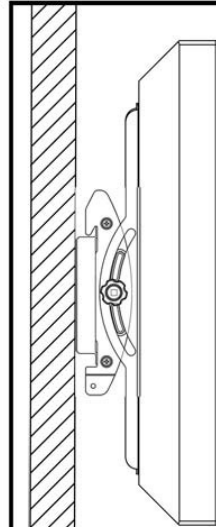

SAFETY LOCK

TILT

6

Tightly secure the safety lock using the allen key.

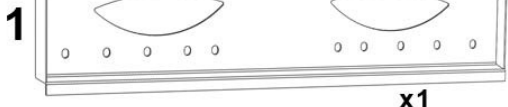

x1

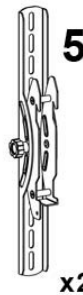

x2

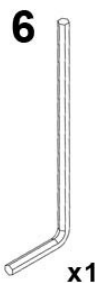

x1



x4



x4

M4



x4

M5



x4

M6



x4

M8

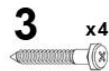

x4



x4

M5



x4

M6



x4

M8

