

UVC-02 WEB PRESENTATION DOCK



“UVC-02 Setup Tool” computer app

Use the “UVC-02 Setup Tool” app for computers to configure the various settings of the UVC-02, as well as to back up the settings of the UVC-02 to a computer connected via USB.

You can download the “UVC-02 Setup Tool” from the UVC-02 product page.

<https://roland.cm/uvc-02/>

Before using the UVC-02, download this app and follow the instructions to install it on your computer (Windows/Mac).

Contents

Panel Descriptions	2	Configuring the Settings (UVC-02 Setup Tool)	7
Top Panel	2	About Your New UVC-02 Setup Tool	7
Rear Panel	3	Setup Tool Screen.....	7
Setup Examples	4	Switching the Functions of the [A1] [A2] Buttons	7
Private Web Meetings	4	Setting the Functions for the [TALK] Button	8
Professional Video Streaming.....	4	Configuring the Audio.....	8
Web Presentations	5	Configuring the Effects	9
Basic Operation	6	System Settings	10
Turning the Power On/Off.....	6	Saving/Refreshing the UVC-02 Settings.....	10
Adjusting the Input Levels	6	Returning to the Factory Settings (Factory Reset)	11
Adjusting the Output Levels.....	6	Updating the UVC-02 System Program	11
Outputting Video	6	Appendix	13
		Troubleshooting.....	13
		Intellectual Property Right	13
		Block Diagram.....	14
		Main Specifications	15

Panel Descriptions

Top Panel

MIC connector (XLR)

Use this connector for audio input. Either a dynamic or a condenser mic can be used.

Phantom Power Settings

The MIC connector can supply phantom power (+48 V). This should be switched on for condenser mics that require phantom power. You can turn phantom power on/off using the switch [PHANTOM +48V] on the rear panel (p. 3).

NOTE

Be sure to turn phantom power off if it's not necessary. Dynamic mics may malfunction when supplied with phantom power.

Pin assignment



Name	Explanation
1 [MONITOR OUT] knob	Adjusts the output level of the MONITOR OUT jack.
2 POWER indicator	When the UVC-02 is on, the indicator lights up green. * When a USB 2.0 cable is connected or in other situations where the UVC-02 cannot operate properly, the indicator blinks red.
3 [HDMI] knob	Adjusts the input level of the HDMI IN connector. The HDMI indicator lights when audio is input.
4 [AUX] knob	Adjusts the input level of the AUX IN jack. The AUX indicator lights when audio is input.
5 [MIC] knob	Adjusts the input level of the mic connected to the MIC connector. The MIC indicator lights when audio is input.
6 [H.MIC] knob	Adjusts the input level of the headset mic connected to the HEADSET (🎧) jack. The H.MIC indicator lights when audio is input.
7 [PHONES] knob	Adjusts the output level to a headset mic connected to the HEADSET (🎧) jack.
8 [SETUP] button	When UVC-02 Setup Tool is installed on a computer that connects to the UVC-02, this button shows or hides UVC-02 Setup Tool. * You can use UVC-02 Setup Tool to configure the various settings.

Name	Explanation
9 [EFFECT] button	Turns the effects on/off. * Use UVC-02 Setup Tool to configure the effects.
10 PHANTOM +48V indicator	This indicator lights when the [PHANTOM +48V] switch located on the rear panel is on. * Even when you switch the [PHANTOM +48V] switch on, the indicator doesn't light up when a USB 2.0 cable is connected or in other situations where the UVC-02 cannot operate properly.
11 [A1] button	You can assign functions to this button like voice change, as well as apply reverb and play sound effects. * You can configure the button's settings using the UVC-02 Setup Tool.
12 [A2] button	* The button assignments are as follows by factory default. A1: Voice change A2: Sound effects
13 [AUDIO OUT] button	When this button is lit, the audio signals from HDMI and AUX are output.
14 [TALK] button	When this button is lit, the audio signals from the mic and headset mic are output.
15 [VIDEO OUT] button	When this button is lit, the video signal is output.

Rear Panel

HEADSET (🎧) jack
(4-pole mini-phone 3.5 mm type)

Connect your headset here.

- * You can use a headset with a 3.5 mm CTIA-type mini plug (4-pole).
- * A regular pair of headphones can also be used.

**MONITOR OUT jack**
(stereo mini type)

These jacks output audio. Connect this jack to your monitor speakers or other audio equipment.

**AUX IN jack**
(stereo mini type)

Use this jack for audio input. Connect audio equipment here, such as a digital audio player.

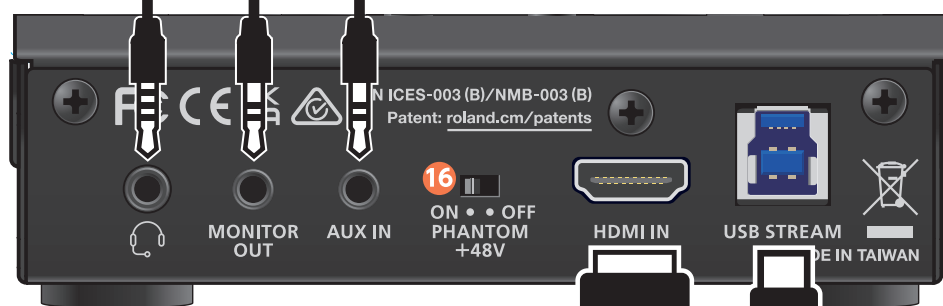

- * To prevent malfunction and equipment failure, always turn down the volume, and turn off all the units before making any connections.

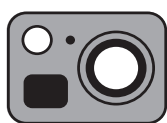
HDMI IN connector

HDMI output connector

Use this connector for video and audio input. Connect your digital camera, video camera, BD player, computer or other device with an HDMI output connector here.

- * This unit does not support HDCP. HDCP copy-protected contents can't be inputted.
- * This unit does not support interlace formats such as 1080i or 720i.

16 [PHANTOM +48V] switch

Switches phantom power on/off. Turn this on if you are using a condenser mic.

- * Be sure to turn this off when you are plugging in or unplugging the mic.
- * Make sure that this is turned off when you use a dynamic mic.
- * Phantom power is unavailable when a USB 2.0 cable is connected or in other situations where the UVC-02 cannot operate properly.

USB STREAM port

USB 3.0 port

Connect your computer here. This port outputs the video/audio from the UVC-02 to your computer. This lets you input audio from your computer.

- * Use the included USB 3.0 cable to connect this port to the USB 3.0 port on your computer.
- * If you connect via an extension cable or a USB hub, the computer might not recognize the UVC-02. We recommend that you connect the UVC-02 directly to your computer.

Setup Examples

Private Web Meetings

You can use a high-quality camera and mic with this unit to smoothly hold Web meetings with excellent image quality and sound.

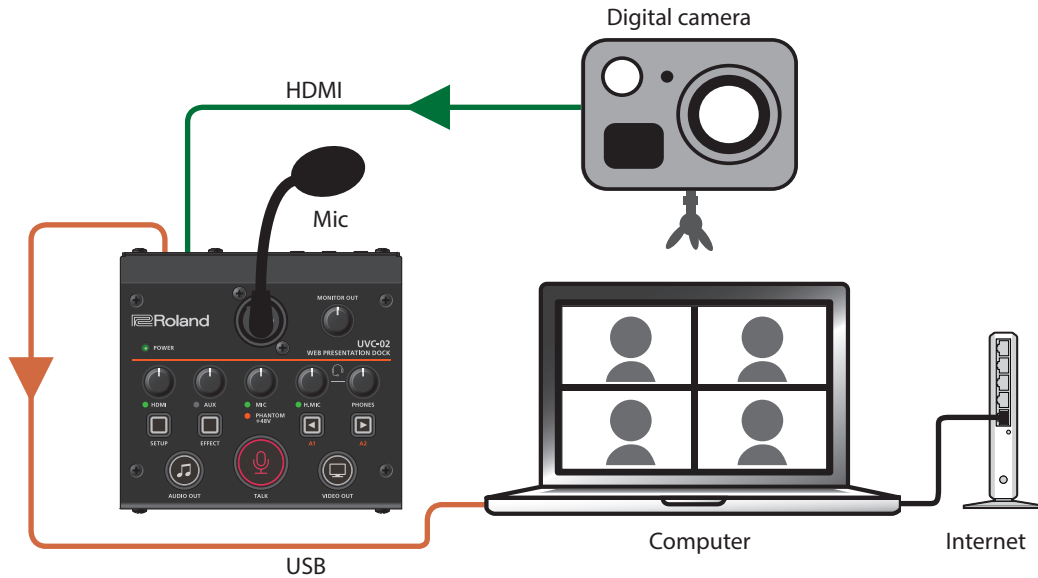

Professional Video Streaming

By connecting a V-1HD+ or other video switcher to this unit, you can use multiple cameras to send a full-fledged video feed to your computer.

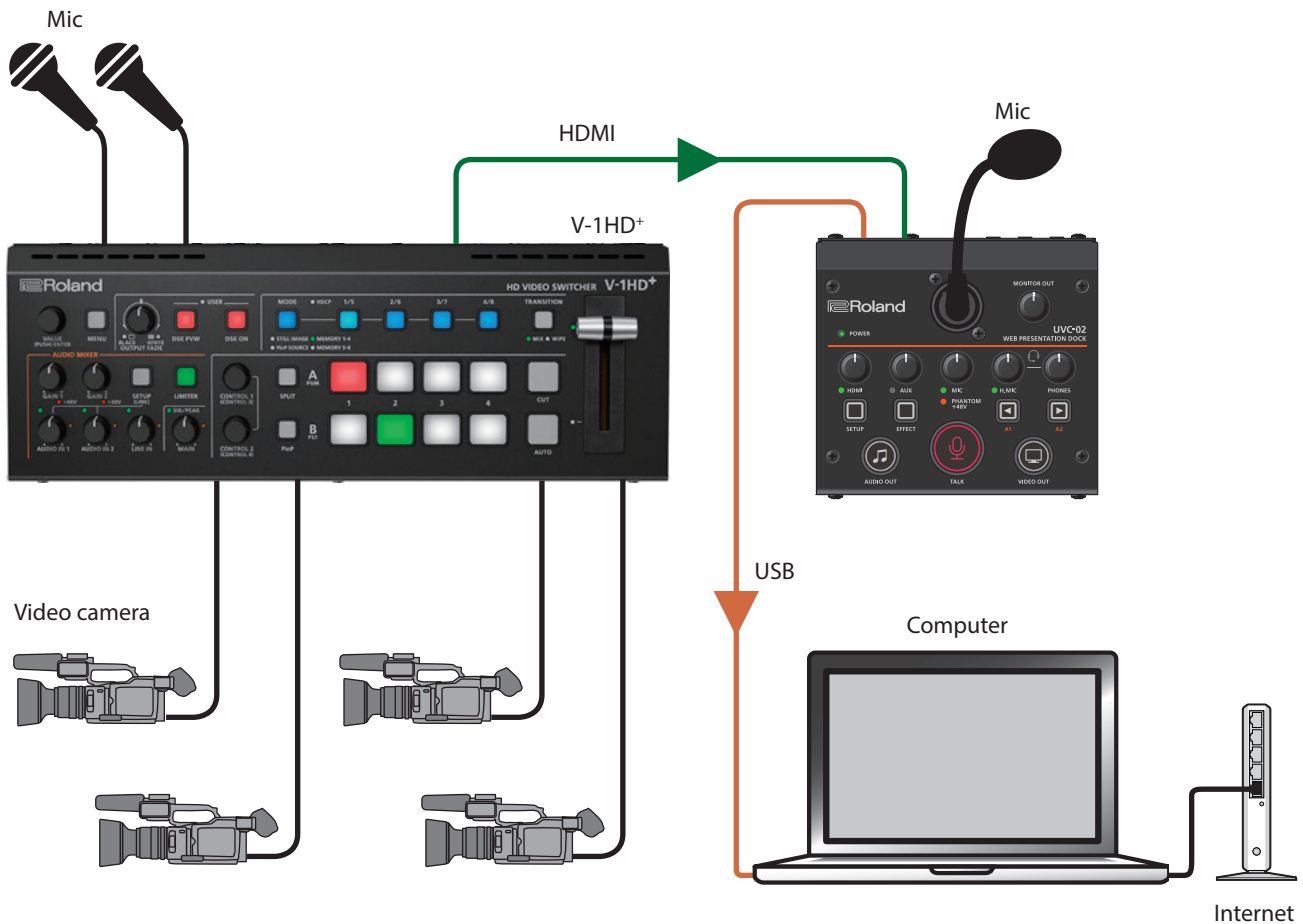

Web Presentations

You can use this unit to input and stream the video from a presentation or other documents shown by a presenter, even where the presenter is using a different computer from the computer doing the streaming.

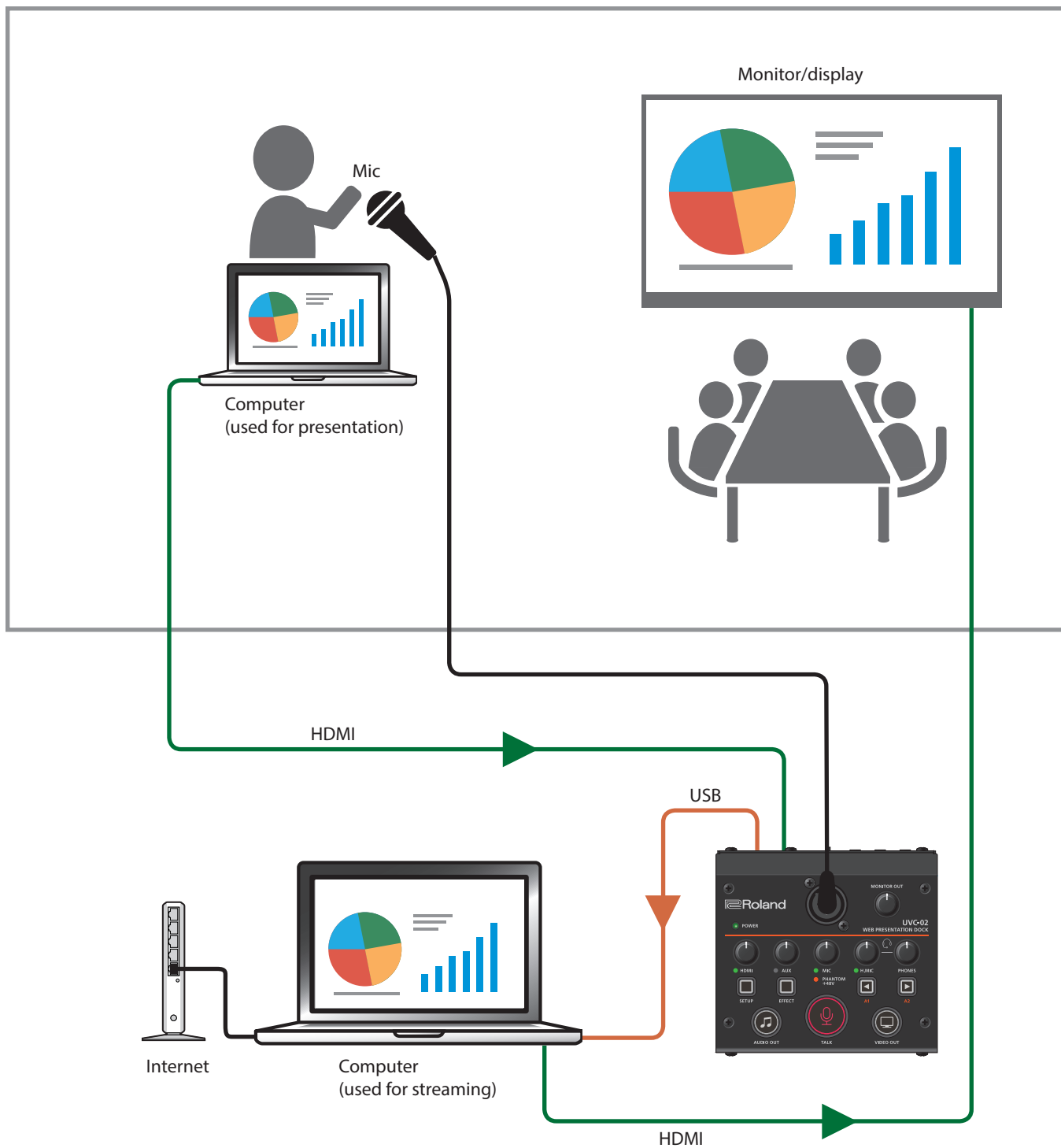

Basic Operation

Turning the Power On/Off

The UVC-02 operates using bus power from the USB port of your computer.

- * Before turning the unit on/off, always be sure to turn the volume down. Even with the volume turned down, you might hear some sound when switching the unit on/off. However, this is normal and does not indicate a malfunction.

Turning the Power On

1. Make sure that all devices are powered off.
2. Turn on your computer.
3. Connect your computer to the UVC-02 with the included USB cable.



The power to the UVC-02 is turned on.

4. Turn on the power in the order of source devices → output devices.

NOTE

When a USB 2.0 cable is connected or in other situations where the UVC-02 cannot operate properly, the POWER indicator blinks red. In this case, the following functions are unavailable.

- Phantom power
- Video input/output

Turning the Power Off

1. Turn off the power in the order of output devices → source devices.
2. Remove the USB cable connecting your computer to the UVC-02.

The power to the UVC-02 is turned off.

Adjusting the Input Levels

Adjust the input levels according to the devices that are connected.

1. Use the [HDMI] knob to adjust the input level of the HDMI IN connector.
2. Use the [AUX] knob to adjust the input level of the AUX IN jack.
3. Use the [MIC] knob to adjust the input level of the MIC connector.
4. Use the [H.MIC] knob to adjust the input level of the HEADSET jack.

MEMO

The indicators change color according to the volume of the input signal. Use the knobs to adjust the levels so that the indicators do not light up red when the signal is at maximum volume.

Unlit	Less than -48 dB
Green	-48--3 dB
Red	-3 dB or more

Adjusting the Output Levels

Adjust the output levels according to the devices that are connected.

1. Press the [AUDIO OUT] button or [TALK] button to make them light up, according to the devices you've connected.
2. Use the [MONITOR OUT] knob to adjust the output level of the MONITOR OUT jack.
3. Use the [PHONES] knob to adjust the output level of the HEADSET jack.

Outputting Video

1. Connect the video source device to the HDMI IN connector.

The [VIDEO OUT] button lights when the video source device is connected.

- * The [VIDEO OUT] button goes dark when nothing is connected to the HDMI IN connector.

2. Launch the application you use to view the camera's video on your computer, and select "Roland UVC-02" as the camera device.

The video from the HDMI IN connector is shown on your computer.

- * You can stop the video output by pressing the [VIDEO OUT] button to make it go dark.
- * To resume video output, press the [VIDEO OUT] button again to make it light up.
- * The picture may be somewhat unstable when you restart the video from a stopped state.

MEMO

You can use the UVC-02 Setup Tool to switch between states when the video output has been stopped.

Configuring the Settings (UVC-02 Setup Tool)

About Your New UVC-02 Setup Tool

Use the “UVC-02 Setup Tool” application running on a computer connected via USB to configure the settings of the UVC-02. This application lets you change the button functions, make various settings and back up or restore the settings.



You can download the “UVC-02 Setup Tool” from the UVC-02 product page.

<https://roland.cm/uvc-02/>

- Once you connect your computer on which the application is installed to the UVC-02 by using the included USB cable, UVC-02 Setup Tool starts up automatically.
- You may see an onscreen message like the one shown below if the system program of the UVC-02 is old. If this happens, click the [UPDATE] button to update the system program of the UVC-02.



- You can also press the [SETUP] button on the UVC-02 to close or open the screen.

Setup Tool Screen

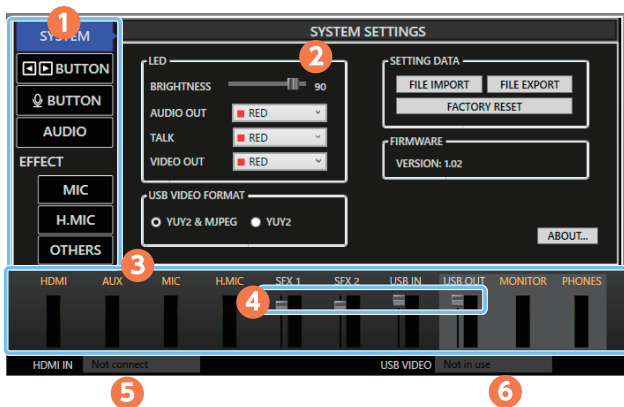

Name	Explanation
1 Page switcher tabs	Click on and select these tabs with your mouse to switch between pages.
2 Settings screen	Shows the settings for each page.
3 Input/output level meters	The level meters for each input/output.
4 Input/output sliders	Drag these sliders with your mouse to adjust the levels for SFX1, SFX2, USB IN and USB OUT.
5 HDMI IN	Shows the input video format.
6 USB VIDEO	“Active” is shown if the UVC-02 is being used as a camera device by an application on your computer. * In the case of a format that is not supported by this unit, it will be displayed in red. Check the format.

Switching the Functions of the [A1] [A2] Buttons

Click the [◀▶] [BUTTON] tab to switch the page.

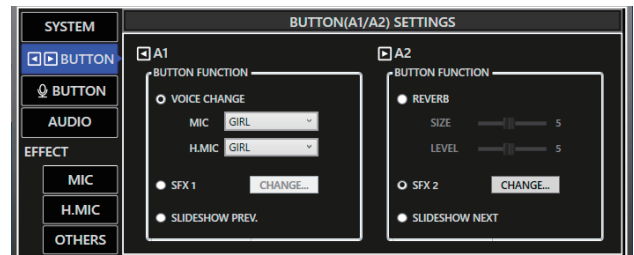

Menu	Value (bold text: default value)	Explanation
A1		
MODE	VOICE CHANGE	This selects the function assigned to the [A1] button. You can select different types of voice change for the MIC and for the H.MIC.
	SFX1	The button makes a sound effect when pressed.
	SLIDESHOW PREV.	Goes back one slide on your computer.
A2		
MODE	REVERB	This specifies the function assigned to the [A2] button. Lets you adjust the reverb size and level.
	SFX2	The button makes a sound effect when pressed.
	SLIDESHOW NEXT	Goes forward one slide on your computer.

MEMO

You can freely assign WAV files on your computer for the SFX1 and SFX2 sounds.

1. Click the [CHANGE] button for A1 and A2 respectively.
2. Click the [FILE OPEN] button.
The file selection dialog box opens.
3. Select the WAV file you want to assign.
This sets the name of the WAV file you selected. Click the [PREVIEW] button to preview the WAV file you set. Click the [PRESET 1] and [PRESET 2] buttons to set the default sound effects.
4. Click the [CHANGE SOUND] button.
The WAV files you selected are uploaded to the UVC-02.
5. Press the [A1]/ [A2] buttons on the UVC-02 to check whether the sounds are playing.

Assignable WAV file formats

- Sample rate: 44.1 kHz/48 kHz
- Bit depth: 16 bits
- Maximum Time: 5 sec.

Setting the Functions for the [TALK] Button

Click the [BUTTON] tab to switch the page.

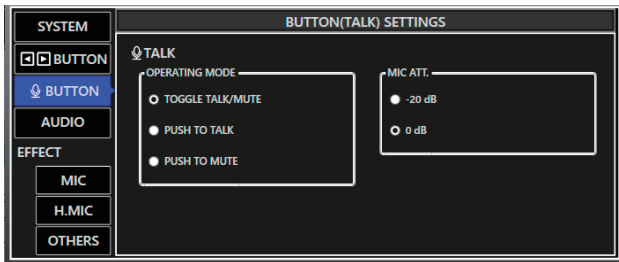

Menu	Value (bold text: default value)	Explanation
TALK		
MODE	This sets what the [TALK] button does.	
	TOGGLE TALK/MUTE	Lets you mute/unmute the audio with each press of the button.
	PUSH TO TALK	The mic audio is output only while you press the button.
	PUSH TO MUTE	The mic audio is muted only while you press the button.
MIC ATT.		
MODE	Reduces the distortion or clipping by attenuating the mic sensitivity.	
	-20dB	Select this when the mic input volume is loud.
	0 dB	Inputs the mic sound without reducing the level. Normally, you should select this setting.

Configuring the Audio

Click the [AUDIO] tab to switch the page.

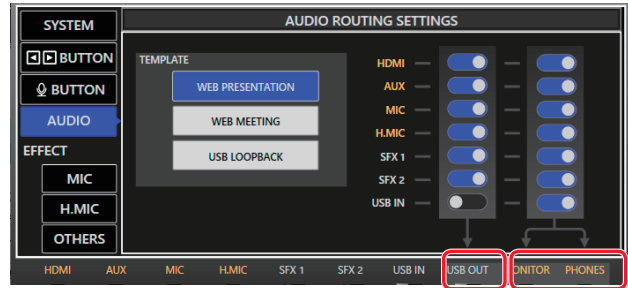

Menu	Value (bold text: default value)	Explanation
ROUTING		
This sets the output destination for the input signals of HDMI, AUX, H.MIC, USB IN, SFX1 and SFX2 respectively.		
To USB OUT	ON, OFF	Sets whether to output each input signal via USB OUT.
To MONITOR/ PHONES	ON, OFF	Sets whether to output each input signal via MONITOR and PHONES.

MEMO

You can use a template to select settings that are most suitable for each situation.

1. Click the [TEMPLATE] button.

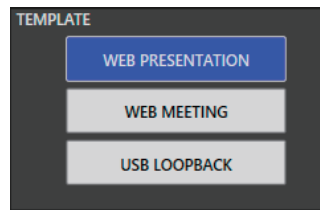

The unit switches to the settings for each template.

Template	Explanation
WEB PRESENTATION	Settings for Web presentations.
WEB MEETING	Settings for Web meetings. The audio from the mic is not outputted to MONITOR OUT or PHONES OUT.
USB LOOPBACK	The audio from the USB input is looped back to the USB output. This is useful for application aside from Web meetings, such as music production.

Configuring the Effects

Click the EFFECT tabs to switch to the respective EFFECT SETTINGS page.

The effect you set here is applied to the respective audio signals when the [EFFECT] button on the UVC-02 is lit.

Also refer to the block diagram (p. 14) for details, such as the arrangement of each effect.

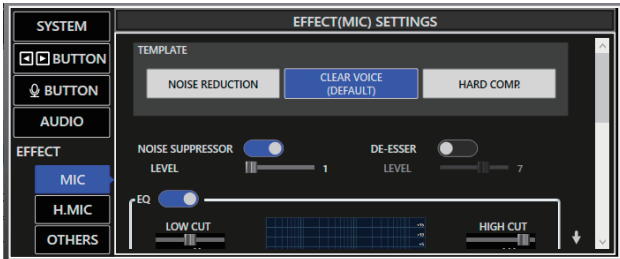

MIC/H.MIC

Parameter	Value (bold text: default value)	Explanation
TEMPLATE		
This is used to make the effect settings, all at once.		
TEMPLATE	NOISE REDUCTION	Appropriate for reducing ambient noise.
	CLEAR VOICE	Appropriate for making voices sound clearer.
	HARD COMP.	Appropriate for picking up even quiet sounds.
NOISE SUPPRESSOR		
Reduces noise.		
SWITCH	OFF, ON	Switches the noise suppressor on and off.
LEVEL	1 –10	Larger values reduce more noise.
DE-ESSER		
Reduces irritating high-frequency sounds like those produced by sibilants.		
SWITCH	OFF , ON	Switches the de-esser on/off.
LEVEL	1 –7–10	Larger values reduce more high-frequency sounds.
EQ		
Adjusts the tonal character.		
SWITCH	OFF, ON	Switches the EQ on/off.
LOW CUT	20– 100 –500Hz	Frequency of the low-end cut filter.
LOW CUT CURVE	-6– -18 –-24dB/Oct	Attenuation curve of the low-end cut filter.
HIGH CUT	2.0– 16.0 –20.0kHz	Frequency of the high-end cut filter.
HIGH CUT CURVE	-6– -24dB/Oct	Attenuation curve of the high-end cut filter.
LO FREQUENCY	20– 250Hz –20kHz	Frequency of the low-end filter.
LO Q	0.3– 1.4 –16.0	The Q of the low-end filter.
LO GAIN	-12– +1 –+12dB	Gain of the low-end filter.
MID FREQUENCY	20– 800Hz –20kHz	Frequency of the midrange band filter.
MID Q	0.3– 1.4 –16.0	The Q of the midrange band filter.
MID GAIN	-12– -2 –+12dB	Gain of the midrange band filter.
HI FREQUENCY	20Hz– 2.5 –20kHz	Frequency of the high-end filter.

Parameter	Value (bold text: default value)	Explanation
HI Q	0.3– 1.4 –16.0	The Q of the high-end filter.
HI GAIN	-12– +3 –+12dB	Gain of the high-end filter.
EXPANDER		
Reduces the level of sounds even further that are quieter than the specified level.		
SWITCH	OFF, ON	Switches the expander on/off.
THRESHOLD	-80– -36 –0dB	Reduces the level of sounds even further that are quieter than the level you specify here.
RATIO	1:1– 1:1.4 –1:INF	The ratio of sound reduction.
ATTACK	1– 50 –100ms	The time it takes before the expander takes effect. (The time shown is a guide only, and varies depending on the volume.)
RELEASE	50– 200ms –5.0s	The time it takes before the expander effect stops. (The time shown is a guide only, and varies depending on the volume.)
COMPRESSOR		
Reduces the level of sounds that exceed the specified level.		
SWITCH	OFF, ON	Switches the compressor on and off.
THRESHOLD	-80– -21 –0dB	Reduces the level of sounds that exceed the level you specify here.
RATIO	1:1– 1:1.2 –1:INF	The ratio of reduction.
POST GAIN	0– +3 –+30dB	This lets you raise the output level.
ATTACK	1 –100ms	The time it takes before the compressor takes effect. (The time shown is a guide only, and varies depending on the volume.)
RELEASE	50ms– 1.6 –5.0s	The time it takes before the compressor effect stops. (The time shown is a guide only, and varies depending on the volume.)

OTHERS

Parameter	Value (bold text: default value)	Explanation
ECHO CANCELLER		
This makes it harder for the audio coming in via USB to be picked up by the mic. This helps prevent the other person's voice from echoing back to them during a network conference or similar situation.		
SWITCH	OFF, ON	Switches the echo canceller on/off.
LEVEL	1– 3 –5	Larger values make it harder for the USB audio to be picked up.
ANTI-FEEDBACK		
Reduces the feedback that occurs when a mic picks up ambient sound from speakers or headphones.		
SWITCH	OFF, ON	Switches the anti-feedback on/off.
DUCKER		
Lowers the volume of other audio signals when audio is input from the mic.		
SWITCH	OFF , ON	Switches the ducker on/off.
TARGET	HDMI, AUX, USB	Reduces the audio signals whose check boxes you select.

Parameter	Value (bold text: default value)	Explanation
LEVEL	-48-- 36 --18dB	Specifies how much to reduce the volume.
MIC SENS	-30-- 18 --6dB	The ducker effect activates when the mic audio level exceeds the level specified here.
HOLD	1-- 5 --10	Adjusts how long the volume is reduced.
USB IN HIGH CUT		
Applies a high-end filter to the audio inputted via USB.		
SWITCH	OFF, ON	Switches the high-end filter on/off.
FREQUENCY	2.0-- 16.0 --20.0kHz	Frequency of the high-end filter.
OUTPUT AUTO LEVELER		
This levels out the volume level of the audio output.		
SENS	-30-- 12 --6dB	Audio signals that are lower than this level are raised, and audio signals that are higher than this level are lowered.
HOLD	1-- 5 --10	This sets how long the auto leveler effect is held. Smaller values make even minute volume changes uniform in size. Larger values make the volume change smoothly.
OUTPUT DELAY		
You can also adjust the delay time of the output audio.		
USB OUT SWITCH	OFF , ON	When this is ON, latency is added to the USB OUT audio.
USB OUT TIME	0.0-- 100.0 --1000.0ms	Adjusts the latency time.
MONITOR/PHONES SWITCH	OFF , ON	When this is ON, latency is added to the MONITOR OUT and PHONES OUT audio.
MONITOR/PHONES TIME	0.0-- 100.0 --1000.0ms	Adjusts the delay time of the audio.

Menu	Value (bold text: default value)	Explanation
LED		
BRIGHTNESS	0-- 90 --100	Adjusts the brightness of all indicators.
AUDIO OUT	RED , GREEN, YELLOW, BLUE, PURPLE, CYAN, WHITE	Sets the color of the button indicators.
TALK		
VIDEO OUT		
USB VIDEO FORMAT		
USB VIDEO FORMAT	YUY2&MJPEG	Support both uncompressed YUY2 format and compressed MJPEG format.
	YUY2	Only support uncompressed YUY2 format. The format that can be received are 1080p, 720p, 480p, 576p, and UXGA (1600 x 1200).

Saving/Refreshing the UVC-02 Settings

You can save the settings of the UVC-02 to a file, and save this on your computer. The settings in the file you saved can be recalled if needed by opening the file and restoring them to the UVC-02.

Saving to a file (FILE EXPORT)

1. Select by clicking the [SYSTEM] tab.
2. Click the [FILE EXPORT] button.

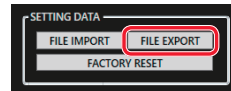

The file save dialog box opens.

3. Specify the file save destination and filename (with a .uvc02 extension), and click the [SAVE] button.

The backup file (.uvc02) is saved to your computer.

Refreshing the settings from a file (FILE IMPORT)

NOTE

Once you perform this operation, the settings on the UVC-02 are overwritten.

1. Select by clicking the [SYSTEM] tab.
2. Click the [FILE IMPORT] button.

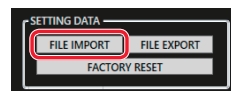

The file selection dialog box opens.

3. Click the backup file (.uvc02), and click the [OPEN] button.

System Settings

Click the [SYSTEM] tab to switch the page.

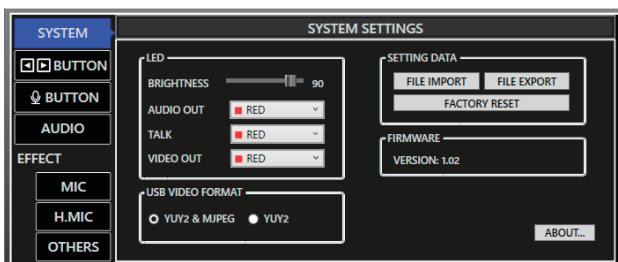

Returning to the Factory Settings (Factory Reset)

Here's how you can return the settings of the UVC-02 to their factory-set state. If the unit does not operate as described even though you've followed the steps in the manual, try executing a factory reset.

NOTE

When you execute a factory reset, all of the settings you made are lost

1. Select by clicking the [SYSTEM] tab.
2. Click the [FACTORY RESET] button.

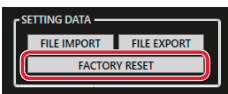

A confirmation dialog box opens. To cancel, click the [CANCEL] button.

3. Click the [OK] button.
The factory reset is executed.

Updating the UVC-02 System Program

Use the Setup Tool to update the system program of the UVC-02.

Checking the version number

1. Select by clicking the [SYSTEM] tab.
2. In the FIRMWARE box, check the current version listed.

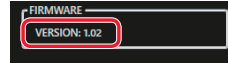

- * You don't need to update the firmware if the latest version is already installed.

Updating

1. Download and install the latest version of Setup Tool.

The latest version can be found on the Roland website as listed below.

<https://roland.cm/uvc-02/>

2. Connect the unit to your computer with the included USB cable.

A screen like the one shown below appears.

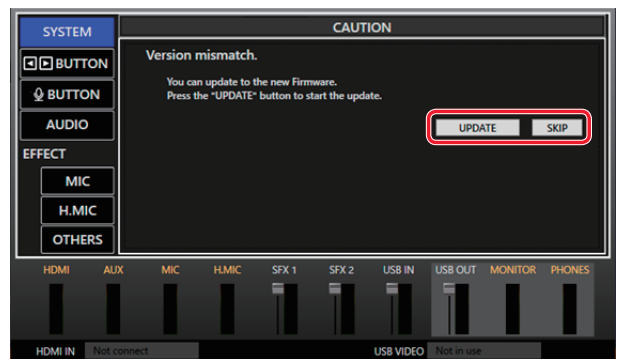

MEMO

- You can click the [SKIP] button if you want to keep using the unit without updating.
- The [SKIP] button may not appear if there has been a major change in specifications.

3. Click the [UPDATE] button.

The update begins.

The settings of the UVC-02 are automatically saved to your computer during the update.

The UVC-02 button blinks during the update.

NOTE

Never turn off the power while the update is in progress (the [TALK] button blinks red while the UVC-02 is updating). Failure to observe this may cause the UVC-02 to malfunction.

Once the update is completed, "FIRMWARE Update Complete." appears on the screen, and the [AUDIO OUT], [TALK] and [VIDEO OUT] buttons on the UVC-02 light up blue.

4. Unplug the USB cable.

The power to the UVC-02 is turned off.

5. Reconnect the USB cable after a while (about five seconds).

The UVC-02 restarts, and a screen like the one below appears in the Setup Tool.

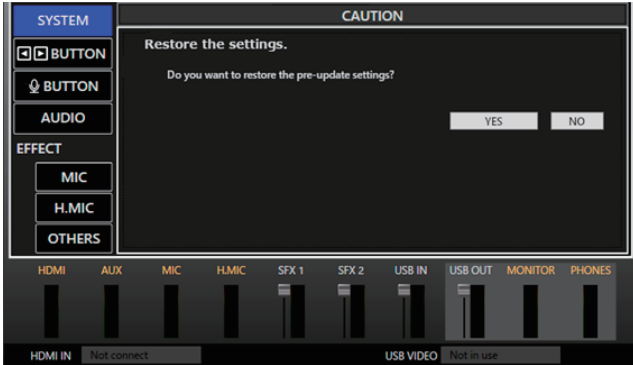

6. To revert to the previous settings before updating, click "YES"; and if you don't need to revert, click "NO".

You can save your settings to a file even if you've selected "NO".

Appendix

Troubleshooting

If you suspect a malfunction, please check the following points.
If this does not resolve the problem, contact a nearby Roland Service Center.

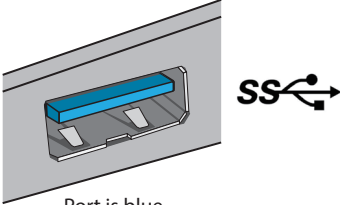
Problem	Items to check	Action	Page
Video-related problems			
No video input	The UVC-02 does not support copy-protected video.	–	–
	Might the video you're inputting be in interlace format, such as 1080i? (The UVC-02 does not support interlace formats.)	–	–
Video input from a computer is distorted.	If video is being input from a computer, the image can sometimes be skewed, flickering, or otherwise distorted.	This is a phenomenon called "tearing," and is not a malfunction.	–
Audio-related problems			
No audio is output.	Is the volume turned down on the UVC-02?	Raise the volume.	p. 2
Audio volume is low.	Could the sound be muted (silenced)?	Unmute the sound.	p. 2
Problems with power			
Power does not turn on Power does not stay on, and shuts off right away POWER indicator blinks red	Are you connecting to a USB 2.0 port? Are you using a USB 2.0 cable? Are you connected via a USB hub?	Use the included USB cable to connect the USB port of this unit to a USB 3.0-compatible port on your computer.  Port is blue	p. 3

Intellectual Property Right

- This product includes third party open source software.
Copyright © 2009-2018 Arm Limited. All rights reserved.
Licensed under the Apache License, Version 2.0 (the "License");
You may obtain a copy of the License at
<http://www.apache.org/licenses/LICENSE-2.0>
- Zoom and the Zoom logo are trademarks of Zoom Video Communications, Inc.
- (C)2021 Cisco Systems, Inc. All rights reserved. Cisco, Cisco logo, Webex by Cisco, and Webex are registered trademarks or trademarks of Cisco Systems, Inc. and/or its affiliates in the U.S. and certain other countries.
- Microsoft and PowerPoint are either registered trademarks or trademarks of Microsoft Corporation in the United States and/or other countries.

Block Diagram

UVC-02 Audio Block Diagram

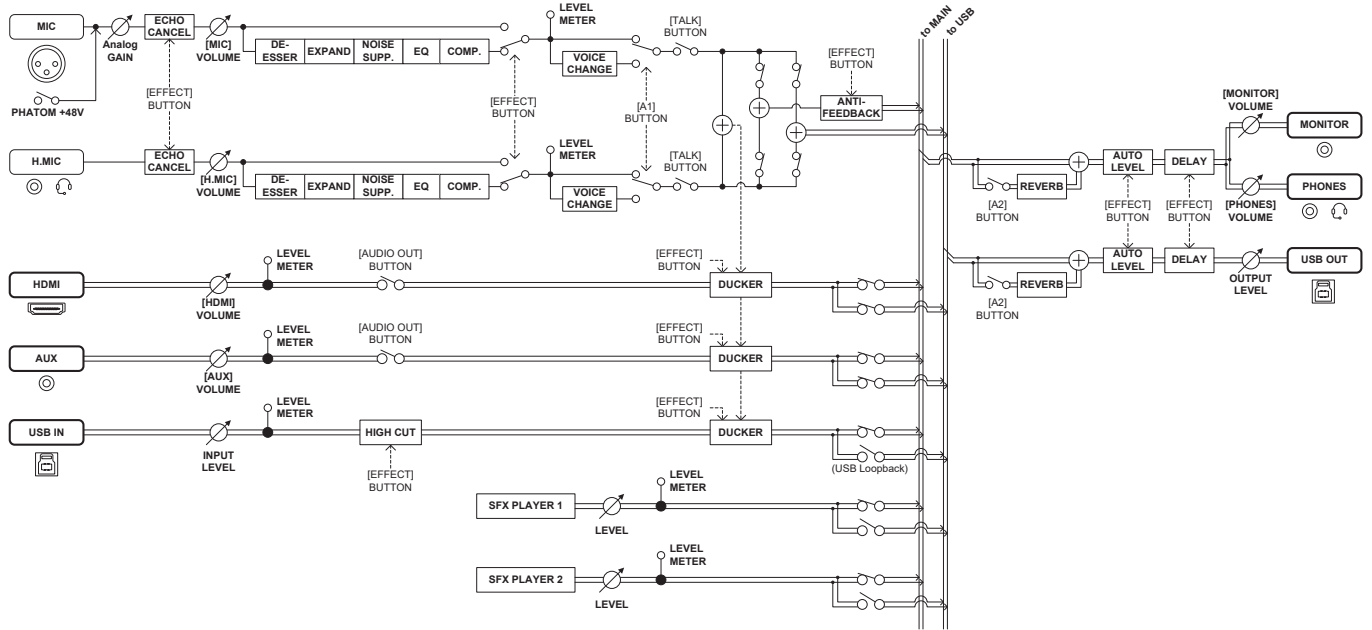

UVC-02 Video Block Diagram

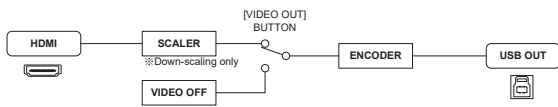

Main Specifications

■ VIDEO Section		
Input Connector	HDMI IN	HDMI type A * HDCP not Supported * Multi-format Supported
Input Formats	480/59.94p, 576/50p, 720/59.94p, 720/50p, 1080/29.97p, 1080/25p, 1080/59.94p, 1080/50p, SVGA (800 x 600) 60 Hz / 75 Hz, XGA (1024 x 768) 60 Hz / 75 Hz, WXGA (1280 x 800) 60 Hz / 75 Hz, HD (1280 x 720) 60 Hz / 75 Hz, SXGA (1280 x 1024) 60 Hz / 75 Hz, FWXGA (1366 x 768) 60 Hz / 75 Hz, SXGA+ (1400 x 1050) 60 Hz / 75 Hz, UXGA (1600 x 1200) 60 Hz, FHD (1920 x 1080) 60 Hz * The refresh rate is the maximum value of each resolution. * Conforms to CEA-861-E, VESA DMT Version 1.0 Revision 11.	
Output Connectors	USB STREAM	USB 3.0 B
USB Video Output Format	YUY2 (Uncompressed), Motion JPEG (Compressed)	
USB Video Output Resolution	1920 x 1080, 1280 x 720, 640 x 480 * Maximum frame rate is 60 fps.	
■ AUDIO Section		
Audio Processing	Sample Rate	48 kHz, 24 bits
Analog Connectors	MIC	XLR type (Balanced, Phantom power DC 48 V, 14 mA Max)
	HEADSET	Stereo miniature phone type (CTIA, PLUG-IN power)
	AUX IN	Stereo miniature phone type
	MONITOR OUT	Stereo miniature phone type
Digital Connectors	HDMI IN	HDMI Type A
	USB STREAM	USB 3.0 B
Nominal Input Level	MIC IN	-54 to -14 dBu (Maximum input level: +4 dBu)
	HEADSET	-20 dBu (Maximum input level: -2 dBu)
	AUX IN	-10 dBu (Maximum input level: +8 dBu)
Nominal Output Level	MONITOR OUT	-10 dBu
	HEADSET	9 mW + 9 mW (32 Ω load)
Input Impedance	MIC IN	5.8 kΩ
	AUX IN	10 kΩ
	HEADSET	1 kΩ
Output Impedance	MONITOR OUT	1 kΩ
	HEADSET	22 Ω
Digital Audio Format	HDMI IN	Linear PCM, 48 kHz/44.1 kHz, 24/20/16 bits, Stereo
	USB STREAM	Linear PCM, 48 kHz, 16 bits, Stereo
Audio Effects	Anti-Feedback, Echo Canceller, Ducker, Voice Change, Reverb, Noise Suppressor, Equalizer, Expander, Compressor, Delay	
Audio File Player	Number of Tracks	2
	Data Formats	WAV (Linear PCM, 48 kHz, 16 bits, stereo/mono)
	Maximum Time	5 seconds/track
■ Common Section		
Other functions	MIC Mute (TALK button) Audio Mute (AUDIO OUT button) Video Off (VIDEO OUT button) Slideshow Control	
Power Supply	Supplied from the computer via USB	
Current Draw	900 mA (4.5 W)	
Operation Temperature	+0 to +40 degrees Celsius +32 to +104 degrees Fahrenheit	
Dimensions	124 (W) x 117 (D) x 52 (H) mm 4-15/16 (W) x 4-5/8 (D) x 2-1/16 (H) inches	
Weight (excluding cables)	460 g 1 lb 0.3 oz	
Accessories	Leaflet "Read Me First," USB 3.0 cable	

* 0 dBu = 0.775 Vrms

* This document explains the specifications of the product at the time that the document was issued. For the latest information, refer to the Roland website.