

## 1 Check the included items

As soon as you open the package, check to see that all items are included. If anything is missing, please contact your dealer.

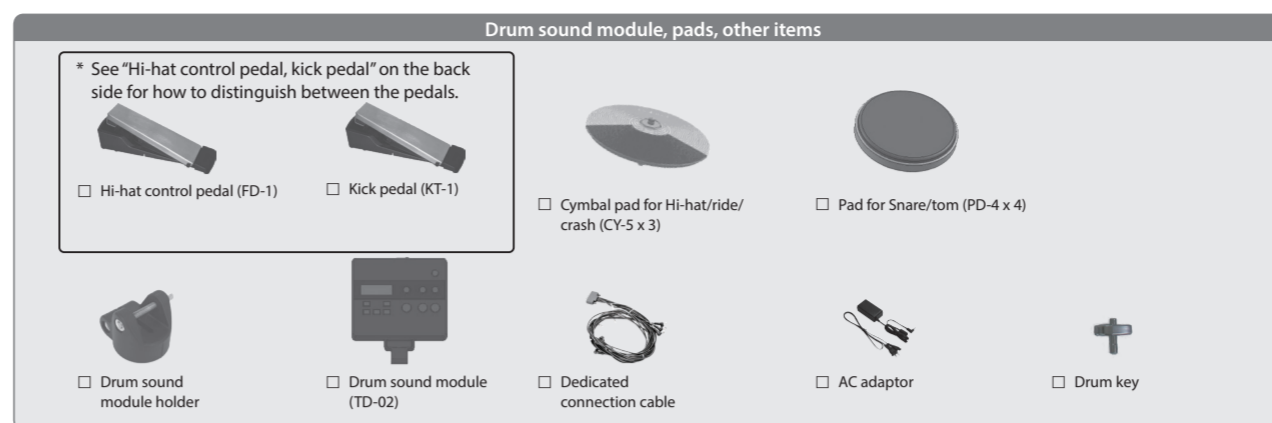
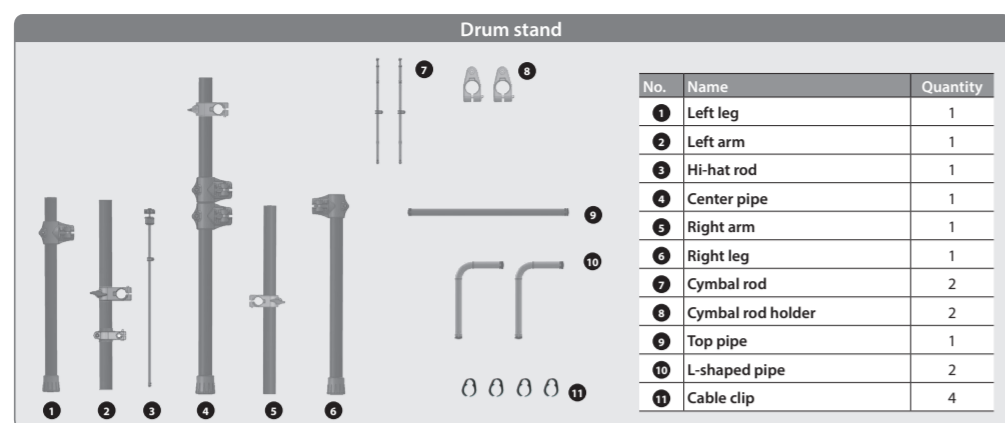

### Accessing the TD-02 Owner's Manual

Refer to the "Owner's Manual" (Roland website) for details on how to use TD-02. Use this 2D code to access the website.



### Accessing the video manual

You can scan the following 2D code to see a quick start video. This video explains the steps for assembly.



## 2 Assemble the drum stand

- \* If you will be using this drum stand for an extended period of time in the same location, we recommend that you use a drum mat (TDM series) made by Roland to prevent the rubber feet from soiling the surface on which they are placed.
- \* The drum stand assembly procedure is for right-handed players. If you want to set up the stand for left-handed players, refer to "Assembly for left-handed players" in the lower right.

### NOTE

- Be careful not to get your fingers pinched by the movable parts when you set up or adjust the drum stand. If using this in a location where children are present, be sure to provide adult supervision or guidance.
- Be sure that there is plenty of space to safely assemble this instrument.
- Do not use a power tool (e.g., an electric screwdriver) to assemble this instrument. Doing so may damage the screws.
- Do not overtighten the bolts.
- Be careful not to get grease from the bolts on your hands or other items.

### 1. Assembling the left and right arm sections

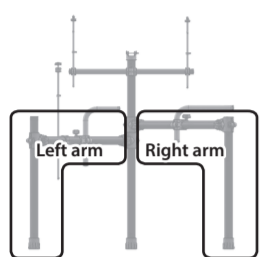

\* Lay the left and right arm sections on the floor while assembling them.

#### Left arm section

- 1-1. Use the drum key to loosen the bolt of the left leg 1, and insert the left arm 2.

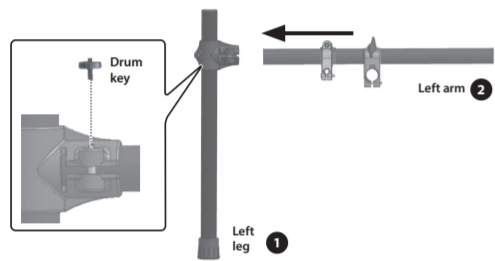

- 1-2. Once the pipe is fully inserted, firmly tighten the bolt with the drum key.

- \* Adjust the hi-hat rod holder of the left arm 2 and the L-shaped pipe holder so that they are facing the same way, as shown in the illustration.

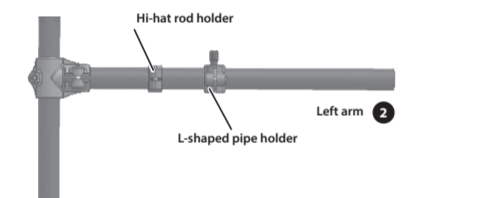

#### Right arm section

- 1-3. Use the drum key to loosen the bolt of the right leg 6, and insert the right arm 5.

- 1-4. Once the pipe is fully inserted, firmly tighten the bolt with the drum key.

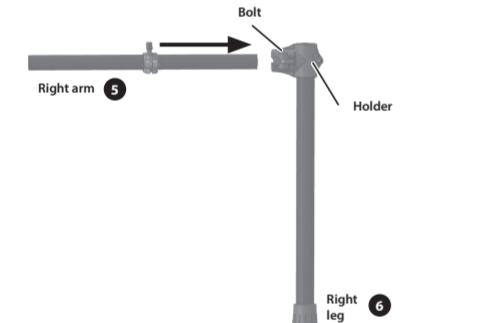

### 2. Attaching the left/right arm sections onto the center pipe

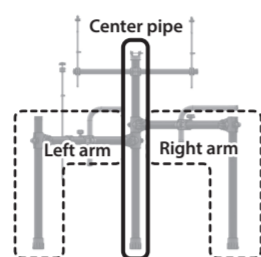

- 2-1. Use the drum key to loosen the bolt of holder A, which is attached to the center pipe 4, and push it down to the left. Insert the left arm you assembled in step 1 into holder A.

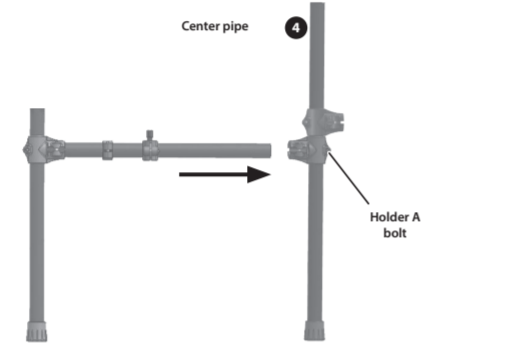

- 2-2. Once the pipe is fully inserted, firmly tighten the bolts (2) of holder A with the drum key.

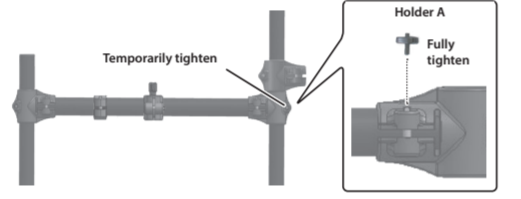

- 2-3. Use the drum key to loosen the bolt of holder B, and insert the right arm you assembled in step 1 into holder B of the center pipe 4.

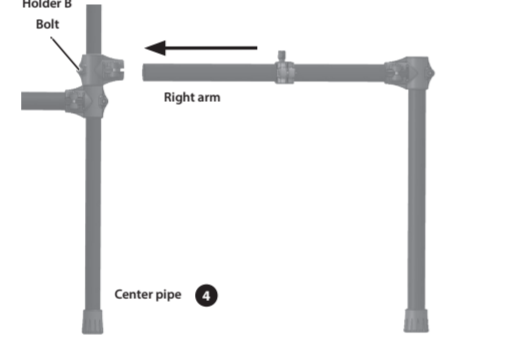

- 2-4. Once the pipe is fully inserted, tighten the bolts (2) of holder B with the drum key.

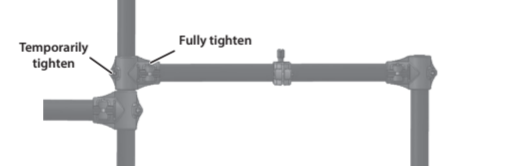

### 3. Adjusting the vertical pipes

- 3-1. Place the center pipe 4 upright, and adjust the angle so that the drum stand can stand up by itself.

- 3-2. Firmly tighten the bolts (2) of holders A and B that you temporarily tightened in step 2.

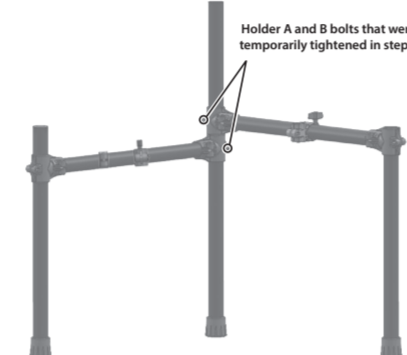

- 3-3. Make sure that the three vertical pipes remain fully upright, and that the left/right arms are fully horizontal.

### 4. Attaching the L-shaped pipe

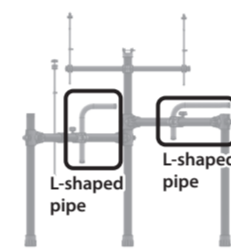

- 4-1. Use the drum key to loosen the bolt of the L-shaped pipe holder for the left arm 2, and insert the L-shaped pipe 10.

- 4-2. Use the drum key to firmly tighten the bolt.

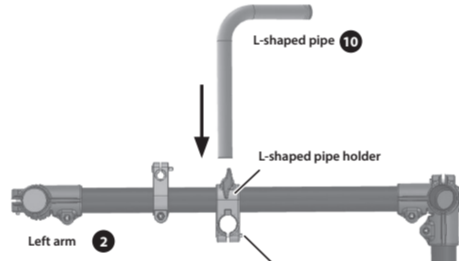

- 4-3. Use the drum key to loosen the bolt of the L-shaped pipe holder for the right arm 5, and insert the L-shaped pipe 10.

- 4-4. Use the drum key to firmly tighten the bolt of the L-shaped pipe holder.

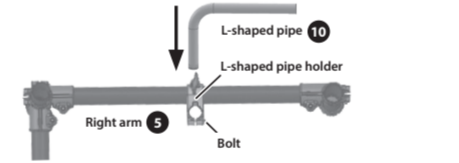

### 5. Attaching the top pipe

- 5-1. Loosen the hand knob on the top of the center pipe 4.

- 5-2. Rotate the holder so that the bolt faces forward, and firmly tighten the hand knob.

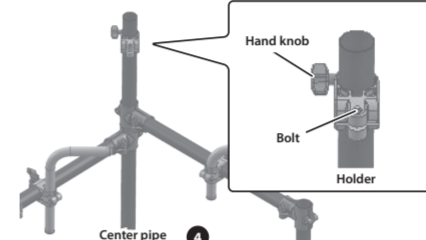

- 5-3. Insert the top pipe into the holder, and use the drum key to firmly tighten the bolt.

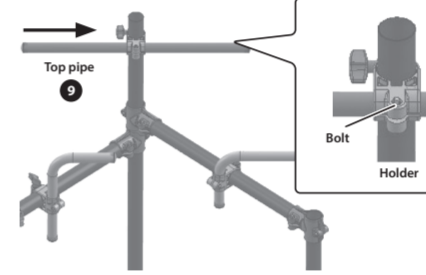

### 6. Attaching the tom pads (T1, T2) and cymbal rod holder

- 6-1. Insert the toms through the top pipe 9, and use the drum key to firmly tighten the bolts (2).

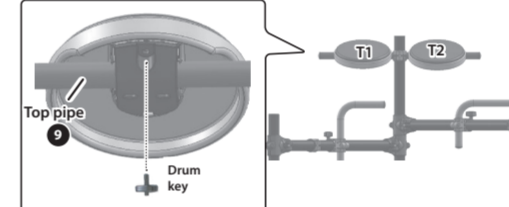

- 6-2. Attach the cymbal rod holder 8 onto the end of the top pipe 9, and firmly tighten the bolts (2) with the drum key.

- \* Attach the cymbal rod holder so that its vertical bolt is on the back side of the stand and the heads of its horizontal bolts are on the outside of the stand, as shown in the illustration.

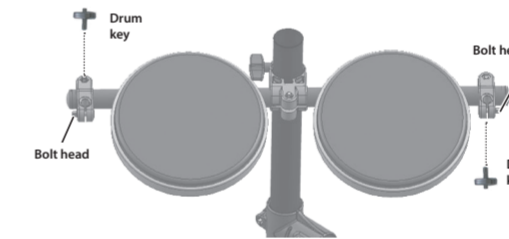

### 7. Attaching the cymbal rod and hi-hat rod

- 7-1. Lock the hi-hat rod holder in place so that its insertion hole is facing to the back of the stand.

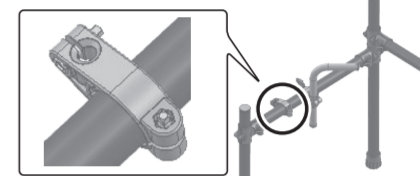

- 7-2. Insert the hi-hat rod 3, the ride cymbal rod 7 and the crash cymbal rod 7 into the holders, and adjust the position and direction of all holders as shown in the illustration to complete the setup.

NOTE  
The tip of the cymbal rod is sharp. Handle it with care.

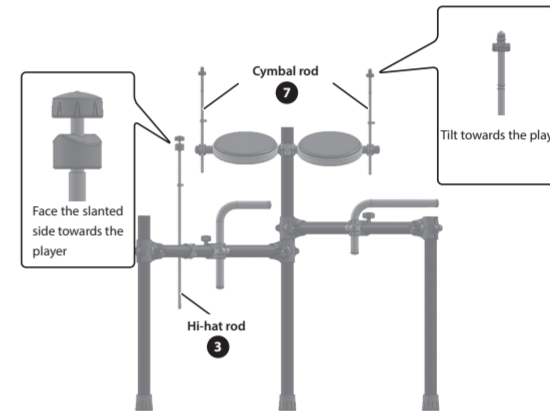

#### Assembly for left-handed players

If you want to use a left-handed setup, assemble the stand as follows.

- Attach the hi-hat rod holder of the left arm 2 onto the right side of the right arm 5.
- Attach the L-shaped pipe 10 onto the L-shaped pipe holder of the right arm 5 (insert the long pipe), and attach the hi-hat rod 3 onto the hi-hat rod holder.
- Attach the L-shaped pipe 10 (insert the short pipe) onto the L-shaped pipe holder of the left arm 2.

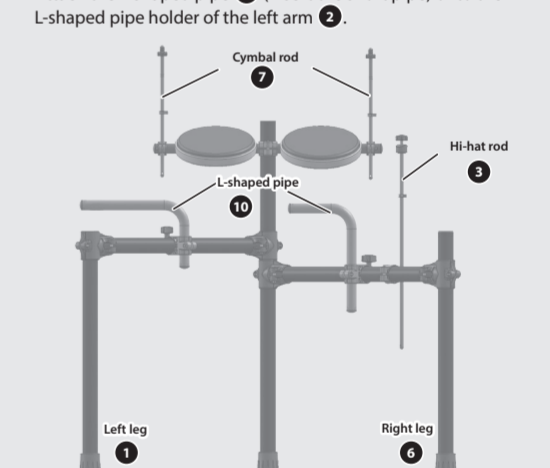

## 3 Attach the parts

- \* Adjust the position and height of the pads and pedals according to your build and preferences, so that they are easy to play.

### NOTE

Be careful not to get your fingers pinched by the movable parts when you operate the drum sound module holder, the hi-hat control pedal, the kick pedal or the cymbals. If using this in a location where children are present, be sure to provide adult supervision or guidance.

#### Attaching the crash cymbal/ride cymbal (CY-5)

Insert the cymbal onto the top of the cymbal rod.

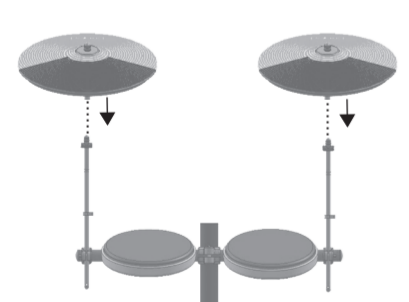

#### Attaching the drum sound module (TD-02)

1. Use the bolt for the drum sound module holder to attach the drum sound module to the holder.



2. Loosen the bolt of the drum sound module holder, attach the holder onto the top of the center pipe and tighten the bolt.



#### Attaching the hi-hat (CY-5)

\* Use the cymbal nut included with the drum stand to attach the hi-hat.

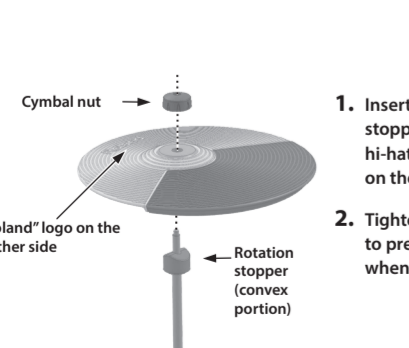

1. Insert the cymbal so that the stopper (convex portion) on the hi-hat rod fits into the concave part on the bottom of the cymbal.
2. Tighten the cymbal nut enough to prevent the pad from wobbling when you strike it.

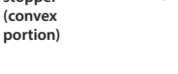

#### Adjusting the position of the cymbal

Adjust the height of the cymbal rod so that the highest point of the cymbal is 115 cm or less.

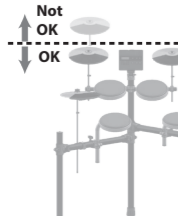

Attach the cymbal rods so that they face straight up, to prevent the drum stand from falling over.

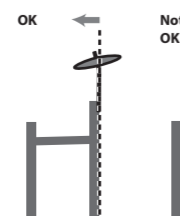

#### Attaching the snare and toms (PD-4)

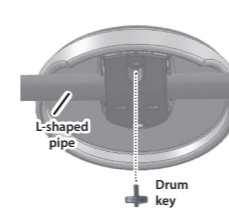

## 4 Connect the pads to the drum sound module (TD-02)

### Connection procedure

1. Connect the dedicated connection cable to the drum sound module as shown in the illustration below. Insert the connector all the way, then turn the knobs to lock it in place.

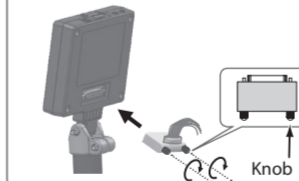

2. Labels indicating the pad to be connected are attached to the dedicated connection cable. Connect the cables by referring to the illustration at right.

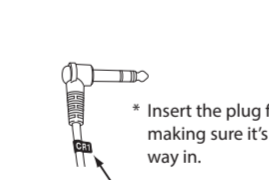

### Cabling diagram for the dedicated connection cable (as seen from the back)

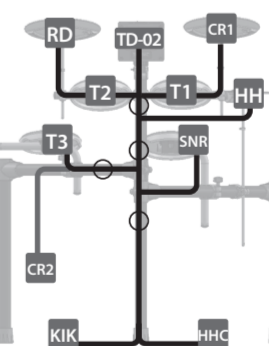

\* Use cable clips 11 to fasten the cables so that they don't obstruct your playing. We recommend attaching the clips in the locations shown with a 0.

"CR2" is not used. You can use a separately sold cymbal set (OP-TD1C) to add more cymbals. If you are not adding this, leave the cap attached. Fasten it so that it does not obstruct your performance.

### For a left-handed setup

Assemble the drum stand as described in "Assembly for left-handed players" in the "2 Assemble the drum stand" section, and then attach the parts and connect the cables as shown in the illustration at right.

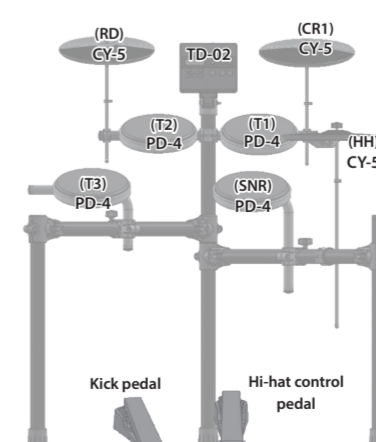

### Cabling diagram for the dedicated connection cable (As seen from the back)

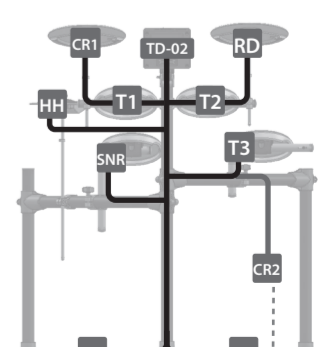

"CR2" is not used. You can use a separately sold cymbal set (OP-TD1C) to add more cymbals. If you are not adding this, leave the cap attached. Fasten it so that it does not obstruct your performance.

This completes assembly and connections.

When you've finished making connections, turn on the power as described on the back side of the "Quick Start" document, and verify that you can hear the sound.

## Detailed explanation of each part

### ■ PD-4 (Snare, Tom)

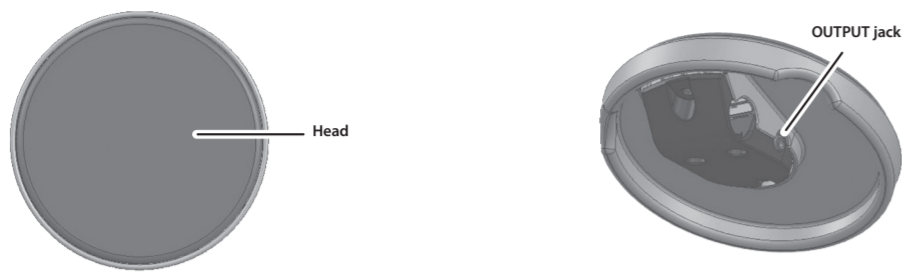

**NOTE**  
PD-4 does not support the use of the rim-shot technique.

### ■ CY-5 (Hi-hat, Ride, Crash)

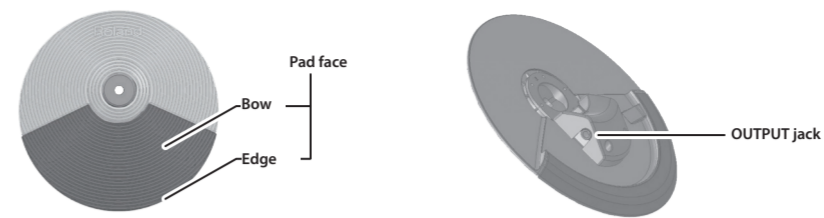

**NOTE**  
Continuous playing may cause dis-coloration of the pad, but this will not affect the Pad's function.

### ■ Hi-hat control pedal, kick pedal

You can check whether the pedal is a kick pedal (KIK) or hi-hat control pedal (HHC) by looking at the sticker on the bottom.

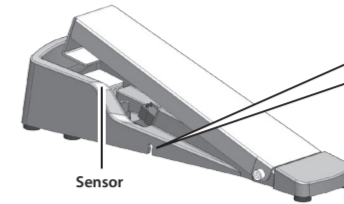
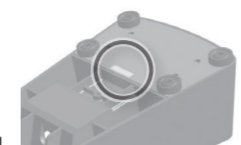

## Quick Start

Playing drums is not only fun, but just about anyone can easily start playing — they make sound when you simply hit them! Let's start playing drums using the wide variety of built-in sounds.

### Turning the Power On/Off

#### Turning the Power On

- Connect headphones (sold separately) or amplified speakers (sold separately) to the TD-02.
  - If amplified speakers are connected, minimize the volume of the amplified speakers.
  - To prevent malfunction and equipment failure, always turn down the volume, and turn off all the units before making any connections.
- Press the [O] (POWER) button.  
The power to the TD-02 is turned on.
- If amplified speakers are connected, turn on the power of the amplified speakers, and adjust the volume.
- Use the [+ ] (VOLUME) buttons on the TD-02 to adjust the volume.

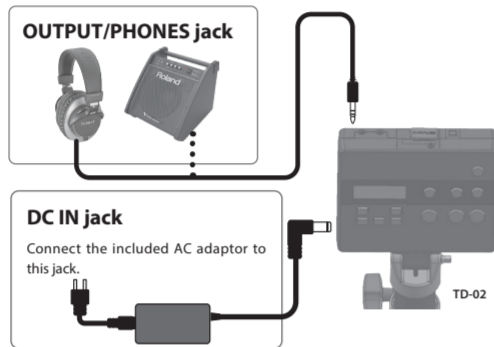

#### Turning the Power Off

- If amplified speakers are connected to the TD-02, turn the volume of the amplified speakers all the way down and then turn the unit off.
- Long-press the [O] (POWER) button on the TD-02.  
The power to the TD-02 is turned off.
  - You must turn off the power by long-pressing the [O] (POWER) button. The settings are not saved if the power supply is disconnected due to the power cord getting pulled out.

#### Using the Auto Off Function

- The power to this unit will be turned off automatically after a predetermined amount of time has passed since it was last used for playing music, or its buttons or controls were operated (Auto Off function). If you do not want the power to be turned off automatically, disengage the Auto Off function.
- Unsaved data is lost when the power turns off. Before turning the power off, save the data that you want to keep.
  - To restore power, turn the power on again.

➔For details on Auto off function, see the 2D code printed on the product to view the "TD-02 Owner's Manual" (Roland website).

### Playing

#### Selecting a Drum Kit

A drum kit consists of sounds assigned to each pad.

- Press the [K] (DRUM KIT) button.

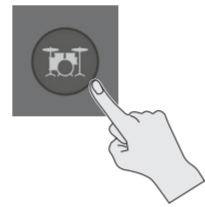

The DRUM KIT screen appears.



- Use the [-] [+] buttons to select a drum kit.

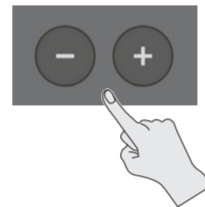

- Play the drums by striking the pad.

### Playing with the Metronome

Here's how you can play the drums while listening to the metronome.

- Press the [M] (METRONOME) button.

The metronome turns on, and the button blinks in time with the metronome tempo.

#### MEMO

You can also hold down the [ENTER] button and press the [M] (METRONOME) button to turn the metronome on/off without switching screens.

- Press the [M] (METRONOME) button again to stop the metronome.

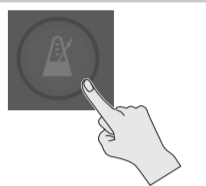

### Changing how the metronome sounds

- In the metronome screen, use the [◀] [▶] buttons to select the item (parameter) that you want to set.
- Use the [-] [+] buttons to edit the value.

Parameter	Value	Explanation
ON/OFF	ON, OFF	Turns the metronome on/off.
Tempo	20-260 (bpm)	Sets the tempo.
Level	-INF-+6.0 dB	Sets the volume.
Beat	1-9 (beat)	Sets the number of beats per measure.
Rhythm	♩ (half note)	Sets the interval of the metronome.
	♩ (quarter notes)	
	♩ (eighth notes)	
	♩ (eighth note triplets)	
	♩ (sixteenth notes)	
Pan	L30-CENTER-R30	Sets the stereo position.
Sound	TYPE1-TYPE15	Sets the sound of the metronome.
LED Sync	ON, OFF	Specifies whether the [M] (METRONOME) button blinks in time with the metronome (ON) or does not blink (OFF).

- Press the [K] (DRUM KIT) button to return to the DRUM KIT screen.

## USING THE UNIT SAFELY

### INSTRUCTIONS FOR THE PREVENTION OF FIRE, ELECTRIC SHOCK, OR INJURY TO PERSONS

#### About ⚠ WARNING and ⚠ CAUTION Notices

<b>⚠ WARNING</b>	Used for instructions intended to alert the user to the risk of death or severe injury should the unit be used improperly.
<b>⚠ CAUTION</b>	Used for instructions intended to alert the user to the risk of injury or material damage should the unit be used improperly. * Material damage refers to damage or other adverse effects caused with respect to the home and all its furnishings, as well to domestic animals or pets.

#### About the Symbols

	The ⚠ symbol alerts the user to important instructions or warnings. The specific meaning of the symbol is determined by the design contained within the triangle. In the case of the symbol at left, it is used for general cautions, warnings, or alerts to danger.
	The ⚡ symbol alerts the user to items that must never be carried out (are forbidden). The specific thing that must not be done is indicated by the design contained within the circle. In the case of the symbol at left, it means that the unit must never be disassembled.
	The ⚠ symbol alerts the user to things that must be carried out. The specific thing that must be done is indicated by the design contained within the circle. In the case of the symbol at left, it means that the power-cord plug must be unplugged from the outlet.

### ALWAYS OBSERVE THE FOLLOWING

#### ⚠ WARNING

##### Concerning the Auto Off function

The power to this unit will be turned off automatically after a predetermined amount of time has passed since it was last used for playing music, or its buttons or controls were operated (Auto Off function). If you do not want the power to be turned off automatically, disengage the Auto Off function.

**Use only the supplied AC adaptor and the correct voltage**  
Be sure to use only the AC adaptor supplied with the unit. Also, make sure the line voltage at the installation matches the input voltage specified on the AC adaptor's body. Other AC adaptors may use a different polarity, or be designed for a different voltage, so their use could result in damage, malfunction, or electric shock.

##### Use only the supplied power cord

Use only the attached power cord. Also, the supplied power cord must not be used with any other device.

#### ⚠ CAUTION

##### Cautions when moving this unit

If you need to move the instrument, take note of the precautions listed below. At least two persons are required to safely lift and move the unit. It should be handled carefully, all the while keeping it level. Make sure to have a firm grip, to protect yourself from injury and the instrument from damage.

- Check to make sure the bolts and hand knobs securing the stand have not become loose. Fasten them again securely whenever you notice any loosening.
- Disconnect the power cord.
- Disconnect all cords coming from external devices.
- Disconnect the connection cable of the kick pedal.
- Disconnect the connection cable of the hi-hat control pedal.

##### Take care so as not to get fingers pinched

When handling the following moving parts, take care so as not to get fingers, toes, etc., pinched. Whenever a child uses the unit, an adult should be on hand to provide supervision and guidance.

- Hi-hat control pedal
- Kick pedal
- Bottom of the cymbal pad (see figure)
- Drum sound module holder (see figure)

##### Keep small items out of the reach of children

To prevent accidental ingestion of the parts listed below, always keep them out of the reach of small children.

- Included Parts
- Cymbal nut
- Removable Parts
- Screws, Bolts, Bluetooth ADAPTOR jack's cover, CR2 plug's cap

## IMPORTANT NOTES

#### Power Supply

- Place the AC adaptor so that the side with text is downward.

#### Placement

- Depending on the material and temperature of the surface on which you place the unit, its rubber feet may discolor or mar the surface.

#### Repairs and Data

- Before sending the unit away for repairs, be sure to write down the needed information. Although we will do our utmost to preserve the data stored in your unit when we carry out repairs, in some cases, such as when the memory section is physically damaged, restoration of the stored content may be impossible. Roland assumes no liability concerning the restoration of any stored content that has been lost.

#### Additional Precautions

- Any data stored within the unit can be lost as the result of equipment failure, incorrect operation, etc. To protect yourself against the irremediable loss of data, be sure to write down the needed information.
- Roland assumes no liability concerning the restoration of any stored content that has been lost.
- Never strike or apply strong pressure to the display.
- This instrument is designed to minimize the extraneous sounds produced when it's played. However, since sound vibrations can be transmitted through floors and walls to a greater degree than expected, take care not to allow these sounds to become a nuisance to others nearby.
- The rubber portion of the striking surface is treated with a preservative to maintain its performance. With the passage of time, this preservative may appear on the surface as a white stain, or reveal how the pads were struck during product testing. This does not affect the performance or functionality of the product, and you may continue using it with confidence.
- Continuous playing may cause dis-coloration of the pad, but this will not affect the pad's function.
- Do not use connection cables that contain a built-in resistor.

#### Intellectual Property Right

- The copyright of content in this product (the sound waveform data, style data, accompaniment patterns, phrase data, audio loops and image data) is reserved by Roland Corporation.
- Purchasers of this product are permitted to utilize said content (except song data such as Demo Songs) for the creating, performing, recording and distributing original musical works.
- Purchasers of this product are NOT permitted to extract said content in original or modified form, for the purpose of distributing recorded medium of said content or making them available on a computer network.
- The Bluetooth® word mark and logos are registered trademarks owned by Bluetooth SIG, Inc. and any use of such marks by Roland is under license.
- This product includes third party open source software. Copyright © 2009-2018 Arm Limited. All rights reserved. Licensed under the Apache License, Version 2.0 (the "License"); You may obtain a copy of the License at <http://www.apache.org/licenses/LICENSE-2.0>
- Roland, V-Drums are either registered trademarks or trademarks of Roland Corporation in the United States and/or other countries.
- Company names and product names appearing in this document are registered trademarks or trademarks of their respective owners.

#### NOTE

Note that the TD-02 does not offer Bluetooth® functionality. You'll need to attach the Boss Bluetooth® Audio MIDI Dual Adaptor (BT-DUAL, sold separately) to use Bluetooth.

## SUPPLIER'S DECLARATION OF CONFORMITY Compliance Information Statement

Model Name : TD-02  
Type of Equipment : Drum Sound Module  
Responsible Party : Roland Corporation U.S.  
Address : 5100 S. Eastern Avenue Los Angeles, CA 90040-2938  
Telephone : (323) 890-3700

### IMPORTANT: THE WIRES IN THIS MAINS LEAD ARE COLOURED IN ACCORDANCE WITH THE FOLLOWING CODE.

BLUE: NEUTRAL  
BROWN: LIVE

As the colours of the wires in the mains lead of this apparatus may not correspond with the coloured markings identifying the terminals in your plug, proceed as follows:  
The wire which is coloured BLUE must be connected to the terminal which is marked with the letter N or coloured BLACK.  
The wire which is coloured BROWN must be connected to the terminal which is marked with the letter L or coloured RED.  
Under no circumstances must either of the above wires be connected to the earth terminal of a three pin plug.

#### For EU countries

English	For information on AC adaptors that can be used with this product, refer to the Roland website.
German	Informationen zu AC-Adaptoren, die mit diesem Produkt verwendet werden können, finden Sie auf der Roland-Internetseite.
French	Pour savoir quels adaptateurs secteur utiliser avec ce produit, consultez le site Web de Roland.
Italy	Per informazioni sui trasformatori in CA che possono essere usati con questo prodotto, consultate il sito Web Roland.
Spanish	Para obtener información sobre los adaptadores de CA que se pueden usar con este producto, consulta el sitio web de Roland.
Portuguese	Para informações sobre adaptadores AC que podem ser usados com este produto, consulte o site da Roland.
Dutch	Raadpleeg de website van Roland als u meer wilt weten over netstroomadapters die u met dit product kunt gebruiken.
Hungarian	A termékhez használható hálózati adapterekkel (AC) kapcsolatos információkért keressze fel a Roland weboldalát.
Czech	Více informací o AC adaptérech, které mohou být využity s tímto produktem, naleznete na internetové stránce společnosti Roland.
Polish	Aby dowiedzieć się do jakich zasilaczy sieciowych można podłączyć ten produkt, zajrzyj na stronie internetowej firmy Roland.
Romanian	Pentru informații privind adaptatoarele de c.a. care pot fi utilizate cu acest produs, consultați site-ul web Roland.
Slovak	Informácie o sieťových adaptéroch na striedavý prúd, ktoré sa dajú použiť s týmto produktom, nájdete na webovej stránke spoločnosti Roland.
Danish	For oplysninger om vekselstrømsadapters, der kan bruges sammen med dette produkt, se Roland-websiteet.
Finnish	Tietoja tämän tuotteen kanssa käytettävistä virtalähteistä saa Rolandin verkkosivustosta.
Swedish	Information om vilka nätadapter som kan användas med den här produkten finns på Rolands webbplats.
Norwegian	For informasjon om vekselstrømsadapters som kan brukes med dette produktet, se Roland-websiteen.

[http://roland.cm/ac\\_adaptor](http://roland.cm/ac_adaptor)

