



Zen Microphone

Wireless Microphone

TABLE OF CONTENT

1. Introduction	03
2. Zen Microphone Overview	04
2.1 Included in the box	04
2.2 Zen Microphone Layout	05
2.3 LED indications	06
3. How to set up	07
3.1 Setting up the Zen Microphone	07
4. How to use	08
4.1 Using the microphone	08
4.2 Automatic power OFF	08
4.3 Capturing the best room measurements	09
5. Troubleshooting.	10
5.1 Factory reset	10
6. Safety & Warnings	11
6.1 Important Safety Instructions	11
6.2 Warning	11
6.3 Compliance	11

1. Introduction

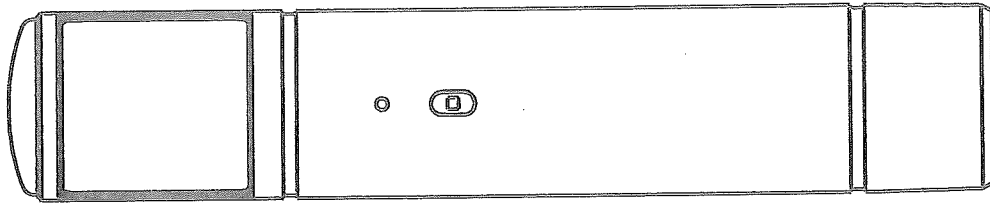

Congratulations on your new *Zen Microphone*. We hope it will improve your listening experience.

The *Zen Microphone* is a calibration tool for collecting room acoustic data. The data is collected during a calibration procedure that last between 30 and 60 seconds and can be done by anyone. The microphone transfers the collected data via network connection to a supported app. The app processes and calibrates the data. Based on the calculations, the optimized result is transferred to your device to improve your audio experience.

2. Zen Microphone Overview

2.1 Included in the box

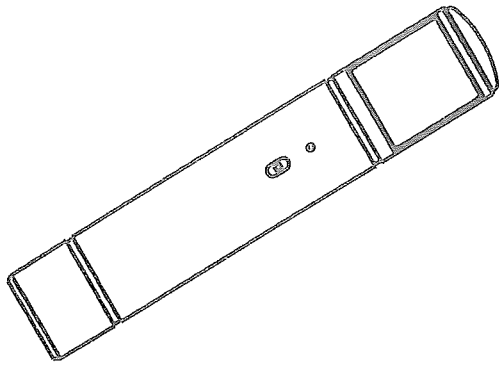

1x Zen Microphone

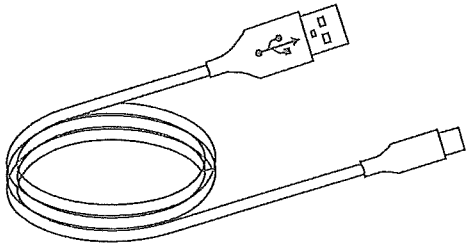

1x Power cable

2.2 Zen Microphone Layout

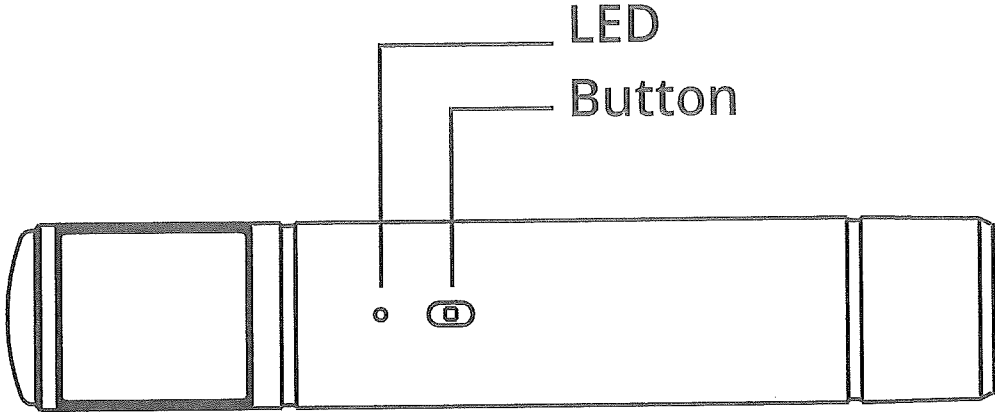

FRONT

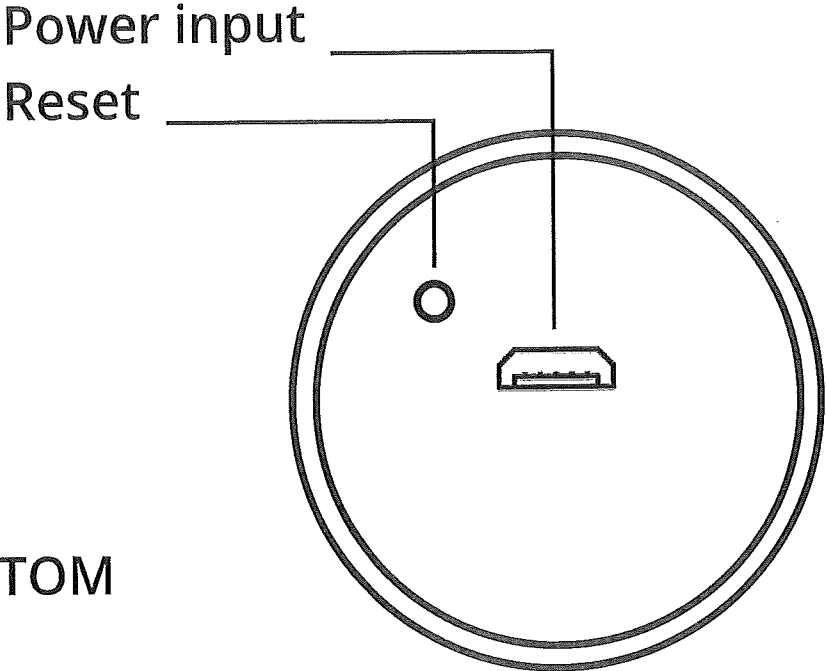

BOTTOM

2.3 LED indications

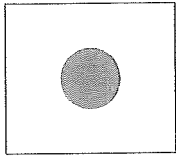

Solid green: Connected / Battery full

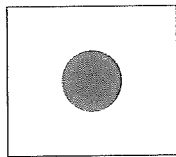

Solid red: Recording / Charging

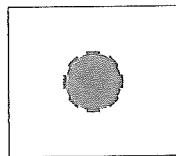

Intermediate red blinking: <20% power

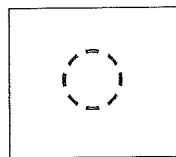

White (slow blink): Searching for network

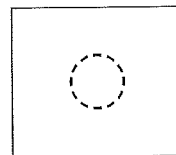

White (rapid blink): Ready to configure

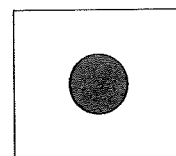

LED OFF: Power OFF

3. How To Set Up

3.1 Setting up the Zen Microphone

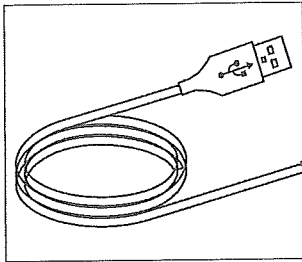

1. Charge microphone

Make sure your microphone is charged. *Charging cable* is supplied with the product.

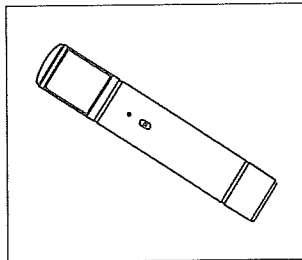

2. Power ON

Turn on the device by clicking the button.

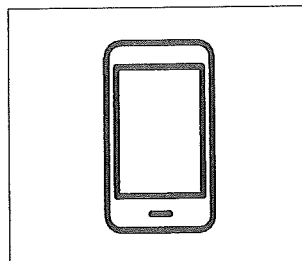

3. Open app

Open the supporting app. If you do not already have the app, download it in App Store or Google Play. The Wi-Fi setup page should open automatically.

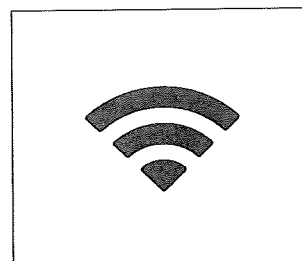

4. Setup Wi-Fi

If the Wi-Fi settings do not open automatically, click the phone icon in the top right corner of the app. Follow the instructions.

NB: Use 2.4GHz network

4. How To Use

4.1 Using the microphone

Short press (if OFF)	Turn ON the <i>Zen Microphone</i>
Short press (if ON)	Start recording (ONLY possible when app shows BEGIN in room EQ)
Hold for 2 sec (if ON)	Turn OFF the <i>Zen Microphone</i>
Hold for 10 sec (if ON)	Factory reset – network is disconnected, and the LED will start flashing white; ready for setup

4.2 Automatic power OFF

The *Zen Microphone* will automatically power OFF after 10 minutes without operation. The *Zen Microphone* will power ON again when the button is pushed.

4.3 Capturing the best room measurements

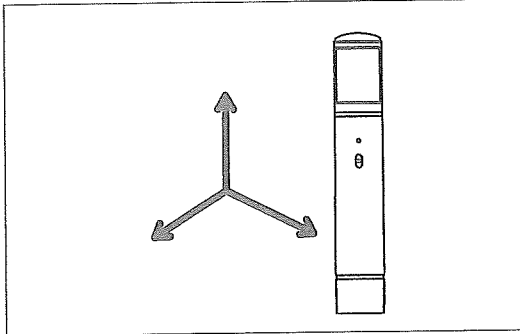

1. Cover the room

To get the best measurement, move around the room. Make sure you measure in different heights and cover the entire room.

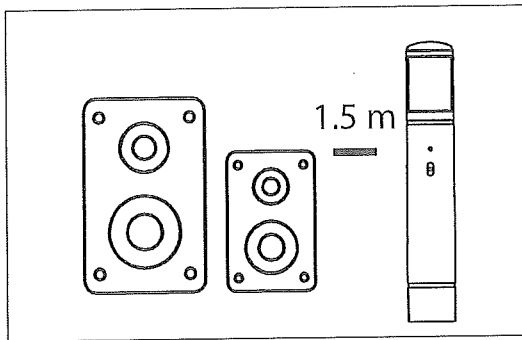

2. Keep distance of 1.5 m

Stand 1.5 meters or more away from the speakers for optimal measurements of the room.

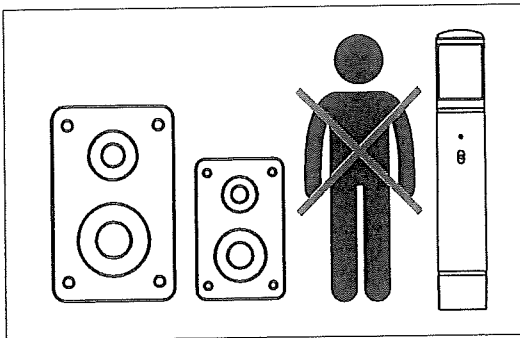

3. Face your speakers

Do not get in between the phone and the speakers, as this affects the measurements.

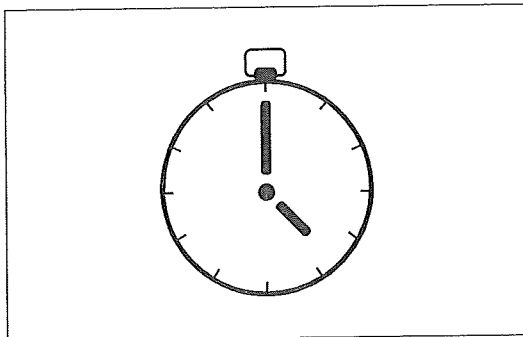

4. 30 seconds minimum

Continue movement around room for approximately 60 seconds. After 30 seconds the test can be stopped if the entire room has been covered.

5. Troubleshooting

5.1 Factory reset

To perform a factory reset, it can be done two ways. Product must have a charged battery while doing this:

- Hold the button for 10 seconds and the product will be reset to factory default. LED will blink quickly when done, indicating it is ready for network setup.
- Press the pinhole button at the bottom. This will remove power from battery and perform a factory default reset. LED will blink quickly when done, indicating it is ready for network setup.

5.2 Update

To update the Zen Microphone to the latest software, press the button quickly 4 times. The LED will start to blink green and blue, wait until the LED is solid green indicating the update is complete.

NB: Make sure the microphone is connected to the internet before updating.

6. Safety & Warnings

6.1 Important Safety Instructions

1. Read these instructions.
2. Keep these instructions.
3. Heed all warnings.
4. Follow all instructions.
5. Do not use this apparatus near water.
6. Clean only with dry cloth.
7. Do not block any ventilation openings. Install in accordance with the manufacturer's instructions.
8. Do not install near any heat sources such as radiators, heat registers, stoves or other apparatus (Including amplifiers) that produces heat.
9. Protect the power cord from being walked on or pinched, particularly plugs, convenience receptacles, and the point where they exit from the apparatus.
10. Only use attachments/accessories specified by the manufacturer.
11. Use only with the cart, stand, tripod, bracked, or table specified by the manufacturer, or sold with the apparatus. When a cart is used, use caution when moving the cart/apparatus combination to avoid injury from tip-over.



12. Unplug this apparatus during lightning storms or when unused for a long period of time.
13. Refer all servicing to qualified service personnel. Servicing is required when the apparatus has been damaged in any way, such as power supply cord or plug is damaged, liquid has been spilled or object have fallen into the apparatus, the apparatus has been exposed to rain or moisture, does not operate normally, or has been dropped.

6.2 Warning

To reduce the risk of fire or electric shock, do not expose this apparatus to rain or moisture.

The apparatus shall not be exposed to dripping or splashing and that no objects filled with liquids, such as vases, shall be placed on the apparatus.

6.3 Compliance

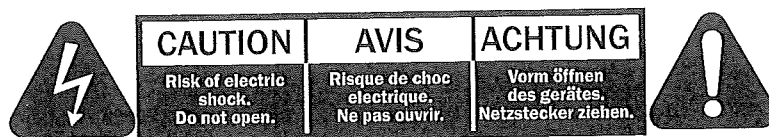

Caution: To prevent the risk of electric shock, do not remove cover (or back). No user-serviceable parts inside. Refer servicing to qualified service personnel.

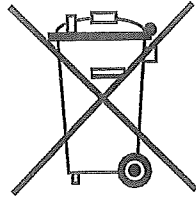

This appliance may not be treated as regular household waste. Management of WEEE (waste electrical and electronic equipment) is applicable in the Member States of the European Union and other European countries with individual national policies on the management of WEEE. If you need more information on the collection, refuse and recycling systems, please contact your local or regional waste administration.

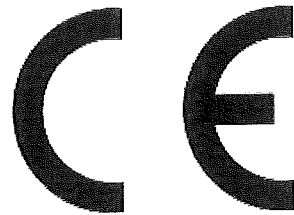

- Ecodesign requirements for Energy-related products Directive (EC)278/2009
- Radio Equipment Directive 2014/53/EU
- The Low Voltage Directive 2014/35/EU

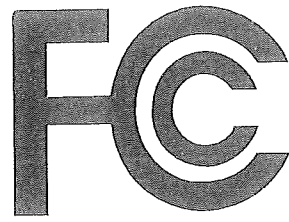

This device complies with Part 15 of the FCC Rules. Its operation is subject to the following two conditions:
(1) This device may not cause harmful interference, and
(2) This device must accept any interference received, including interference that may cause undesired operation.

NOTE: This equipment has been tested and found to comply with the limits for a Class B digital device, pursuant to part 15 of the FCC Rules. These limits are designed to provide reasonable protection against harmful interference in a residential installation. This equipment generates, uses, and can radiate radio frequency energy and, if not installed and used in accordance with the instructions, may cause harmful interference to radio communications.

However, there is no guarantee that interference will not occur in a particular installation. If this equipment does cause harmful interference to radio or television reception, which can be determined by turning the equipment OFF and ON, the user is encouraged to try to correct the interference by one or more of the following measures:
Reorient or relocate the receiving antenna.

Increase the separation between the equipment and receiver.

Connect the equipment into an outlet on a circuit different from that to which the receiver is connected.

Consult the dealer or an experienced radio/TV technician for help.

NOTE: The manufacturer is not responsible for any radio or TV interference caused by unauthorized modifications to this equipment. Such modifications could void the user's authority to operate the equipment.

CAN ICES-003 (B)/NMB-003(B) - Science and Economic Development Canada's licence-exempt RSS(s).

Operation is subject to the following two conditions:

(1) This device may not cause interference.

(2) This device must accept any interference, including interference that may cause undesired operation of the device.

Company Information:

Platin Gate ApS

Anelystparken 31C

8381 Tilst

Denmark

For documentation and other information see:

<https://platinaudio.com/pages/platin-product-documentation>