

DD15 COMPACT DISC TRANSPORT

User Guide



CAUTION

TO REDUCE THE RISK OF FIRE, REPLACE WITH THE SAME TYPE AND RATING OF FUSE.

ATTENTION

UTILISER UN FUSIBLE DE RECHANGE MÊME TYPE.

Safety compliance

This product has been designed to meet the IEC 60065 international electrical safety standard.

CAUTION

RISK OF ELECTRIC SHOCK DO NOT OPEN

ATTENTION

RISQUE DE CHOC ELECTRIQUE NE PAS OUVRIR



The lightning flash with an arrowhead symbol within an equilateral triangle, is intended to alert the user to the presence of uninsulated 'dangerous voltage' within the product's enclosure that may be of sufficient magnitude to constitute a risk of electric shock to persons.



The exclamation point within an equilateral triangle is intended to alert the user to the presence of important operating and maintenance (servicing) instructions in the literature accompanying the product.

CAUTION: To reduce the risk of electrical shock do not remove cover (or back). No user serviceable parts inside. Refer servicing to qualified service personnel.

WARNING: To reduce the risk of fire or electrical shock, do not expose this apparatus to rain or moisture.

CAUTION: In Canada and the USA, to prevent electric shock, match the wide blade of the plug to the wide slot in the socket and insert the plug fully into the socket.

This product is designed and manufactured to meet strict quality and safety standards. However, you should be aware of the following installation and operation precautions.

1. Take heed of warnings & instructions

You should read all the safety and operating instructions before operating this appliance. Retain this handbook for future reference and adhere to all warnings in the handbook or on the appliance.

2. Water and moisture

The presence of electricity near water can be dangerous.

Do not use the appliance near water – for example next to a bathtub, washbowl, kitchen sink, in a wet basement or near a swimming pool, etc.

3. Object or liquid entry

Take care that objects do not fall and liquids are not spilled into the enclosure through any openings. Liquid-filled objects such as vases should not be placed on the equipment.

4. Ventilation

Do not place the equipment on a bed, sofa, rug or similar soft surface, or in an enclosed bookcase or cabinet, since ventilation may be impeded. We recommend a minimum distance of 50mm around the sides and top of the appliance to provide adequate ventilation.

5. Heat

Locate the appliance away from naked flames or heat producing equipment such as radiators, stoves or other appliances (including other amplifiers) that produce heat.

6. Climate

The appliance has been designed for use in moderate climates.

7. Racks and stands

Only use a rack or stand that is recommended for use with audio equipment. If the equipment is on a portable rack it should be moved with great care, to avoid overturning the combination.

8. Cleaning

Unplug the unit from the mains supply before cleaning.

The case should normally only require a wipe with a soft, damp, lint-free cloth. Do not use paint thinners or other chemical solvents for cleaning.

We do not advise the use of furniture cleaning sprays or polishes as they can cause indelible white marks if the unit is subsequently wiped with a damp cloth.

9. Power sources

This appliance must be connected to a mains socket outlet using the supplied power cord. To disconnect this apparatus from power, you must disconnect the power cord. Make sure the power cord is always easily accessible.

Only connect the appliance to a power supply of the type

described in the operating instructions or as marked on the appliance.

This is a Class 1 device and **must** be earthed.

The power switch is a single-pole switch. When the switch is in the "Off" position, the appliance is not completely disconnected from the main power.

10. Power-cord protection

Power supply cords should be routed so that they are not likely to be walked on or pinched by items placed upon or against them, paying particular attention to cords and plugs, and the point where they exit from the appliance.

11. Grounding

Ensure that the grounding means of the appliance is not defeated.

12. Power lines

Locate any outdoor antenna/aerial away from power lines.

13. Non-use periods

If the unit has a stand-by function, a small amount of current will continue to flow into the equipment in this mode. Unplug the power cord of the appliance from the outlet if left unused for a long period of time.

14. Abnormal smell

If an abnormal smell or smoke is detected from the appliance, turn the power off immediately and unplug the unit from the wall outlet. Contact your dealer immediately.

15. Servicing

You should not attempt to service the appliance beyond that described in this handbook. All other servicing should be referred to qualified service personnel.

16. Damage requiring service

The appliance should be serviced by qualified service personnel when:

- A. the power-supply cord or the plug has been damaged, or
- B. objects have fallen, or liquid has spilled into the appliance, or
- C. the appliance has been exposed to rain, or
- D. the appliance does not appear to operate normally or exhibits a marked change in performance, or
- E. the appliance has been dropped or the enclosure damaged.

2.4G and 5G FCC Statements

This device complies with Part 15 of the FCC Rules. Operation is subject to the following two conditions:

1. This device may not cause harmful interference, and
2. This device must accept any interference received, including interference that may cause undesired operation.

Cet appareil est conforme à la section 15 des réglementations de la FCC. Le fonctionnement de l'appareil est sujet aux deux conditions suivantes :

1. cet appareil ne doit pas provoquer d'interférences néfastes, et
2. cet appareil doit tolérer les interférences reçues, y compris celles qui risquent de provoquer un fonctionnement indésirable.

Note: This product has been tested and found to comply with the limits for a Class B digital device, pursuant to Part 15 of the FCC Rules. These limits are designed to provide reasonable protection against harmful interference in a residential installation. This product generates, uses, and can radiate radio frequency energy and, if not installed and used in accordance with the instructions, may cause harmful interference to radio communications. However, there is no guarantee that interference will not occur in a particular installation. If this product does cause harmful interference to radio or television reception, which can be determined by turning the equipment off and on, the user is encouraged to try to correct the interference by one or more of the following measures:

- Reorient or relocate the receiving antenna.
- Increase the separation between the equipment and receiver.
- Connect the equipment into an outlet on a circuit different from that to which the receiver is connected.
- Consult the dealer or an experienced radio/TV technician for help.

Please take attention that changes or modification not expressly approved by the party responsible for compliance could void the user's authority to operate the equipment.

This equipment should be installed and operated with a minimum distance 20cm between the radiator and your body.

Cet équipement doit être installé et utilisé à une distance minimale de 20 cm entre le radiateur et votre corps.

This device complies with Industry Canada licence-exempt RSS standard(s). Operation is subject to the following two conditions:

1. this device may not cause interference, and
2. this device must accept any interference, including interference that may cause undesired operation of the device.

Le présent appareil est conforme aux CNR d'Industrie Canada applicables aux appareils radioexempts de licence. L'exploitation est autorisée aux deux conditions suivantes :

1. l'appareil ne doit pas produire de brouillage, et
2. l'utilisateur de l'appareil doit accepter tout brouillage radioélectrique subi, même si le brouillage est susceptible d'en compromettre le fonctionnement.

Under Industry Canada regulations, this radio transmitter may only operate using an antenna of a type and maximum (or lesser) gain approved for the transmitter by Industry Canada. To reduce potential radio interference to other users, the antenna type and its gain should be so chosen that the equivalent isotropically radiated power (e.i.r.p.) is not more than that necessary for successful communication.

Conformément à la réglementation d'Industrie Canada, le présent émetteur radio peut fonctionner avec une antenne d'un type et d'un gain maximal (ou inférieur) approuvé pour l'émetteur par Industrie Canada. Dans le but de réduire les risques de brouillage radioélectrique à l'intention des autres utilisateurs, il faut choisir le type d'antenne et son gain de sorte que la puissance isotrope rayonnée équivalente (p.i.r.e.) ne dépasse pas l'intensité nécessaire à l'établissement d'une communication satisfaisante.



The CE symbol indicates that this Primare product complies with the EMC (Electromagnetic Compatibility) and LVD (Low Voltage Directive) standards of the European Community.

The WEEE symbol indicates this Primare product complies with the European Parliament and Council Directive 2002/96/EC concerning Waste Electrical and Electronic Equipment (WEEE). This product must be appropriately recycled or processed in accordance with these directives. Consult your local waste disposal authority for guidance.

The RoHS symbol indicates that Primare products are designed and manufactured to comply with the Restriction of Hazardous Substances (RoHS) as stated in the European Parliament and Council Directive 2002/95/EC.

Copyright and acknowledgments

Copyright © 2017-18 Primare AB.

All rights reserved.

Primare AB
Limstensgatan 7
21616 Limhamn
Sweden

<http://www.primare.net>

Issue: DD15/1

The information in this guide is believed to be correct as of the date of publication. However, our policy is one of continuous development and so the information is subject to change without notice, and does not represent a commitment on the part of Primare AB.

Primare is a trademark of Primare AB.

This guide was produced by
Human-Computer Interface Ltd.
<http://www.interface.co.uk>

CONTENTS

WELCOME!

Getting Started

- 1 Unpack the DD15
- 2 Connect to an amplifier
- 3 Connect power
- 4 Play a CD

Back-panel connections

Using the remote control

- Selecting DD15 mode
- Fitting the batteries

Using the DD15

- Front panel controls
- Playing a disc
- Locating a position on the disc

Advanced features

- Changing the front panel display
- Playing a specific track
- Repeat playback

Configuring the settings

- Using the settings menus
- PLAYBACK SETTINGS
- GENERAL SETTINGS

6	Technical specification	13
7	Features	13
7	Outputs	13
7	Performance	13
7	General	13
7	Additional information	14
8	Phase	14
8	Burn-in	14
9	RS232 and trigger	14
9	Using the DD15 with an I15	14
9	Factory reset	14
10	Index	15
10		
10		
10		
11		
11		
11		
11		
12		
12		
12		
12		

WELCOME!

Congratulations on selecting your new DD15 Compact Disc Transport

This user guide describes the features and explains how to set up the compact disc transport for the best sound quality and ease of operation in order to allow for the most enjoyable reproduction of sound from all your sources.

For additional support and assistance please contact your local authorized Primare dealer, or visit our website at www.primare.net.



GETTING STARTED

1 Unpack the DD15

Your DD15 is supplied with:

- This User Guide
- Mains cable
- IR cable
- Trigger cable
- C25 remote control with batteries
- AC Polarity Pen

If any of these items are missing please contact your supplier. We recommend you retain the packaging in case you need to transport the unit at a later date.

Note that the DD15 is supplied with a protective film on the display glass. Remove the film for a clearer whiter display.

2 Connect to an amplifier

Digital outputs

The DD15 Compact Disc Transport provides one coax digital output and one optical digital output for connection to a digital preamplifier or digital surround processor.

- Connect the appropriate output to your preamplifier or surround processor using a suitable cable.

3 Connect power

- Plug one end of the mains cable supplied with the DD15 into the power connector on the back panel, and connect the other end to a wall socket.

If this cable is not suitable for your power outlets please contact your supplier for an alternative cable.

Note: See *Phase*, page 14, for information about getting the best sound from your DD15.



WARNING: Always disconnect the DD15 from the mains power before connecting or disconnecting any cables.

- Switch on the DD15, using the switch on the back panel.

The standby indicator will light up on the front panel.



To switch on from standby

- Press the  button on the front panel or remote control.

The display shows:

PRIMARE

4 Play a CD

- Insert the CD into the slot with the label facing upwards.
- Press the  button on the front panel, or the  button on the remote control, to start playing the disc.

For more information about playing a CD see *Using the DD15*, page 10.

BACK-PANEL CONNECTIONS

The following diagram explains the function of each of the connectors on the back panel:

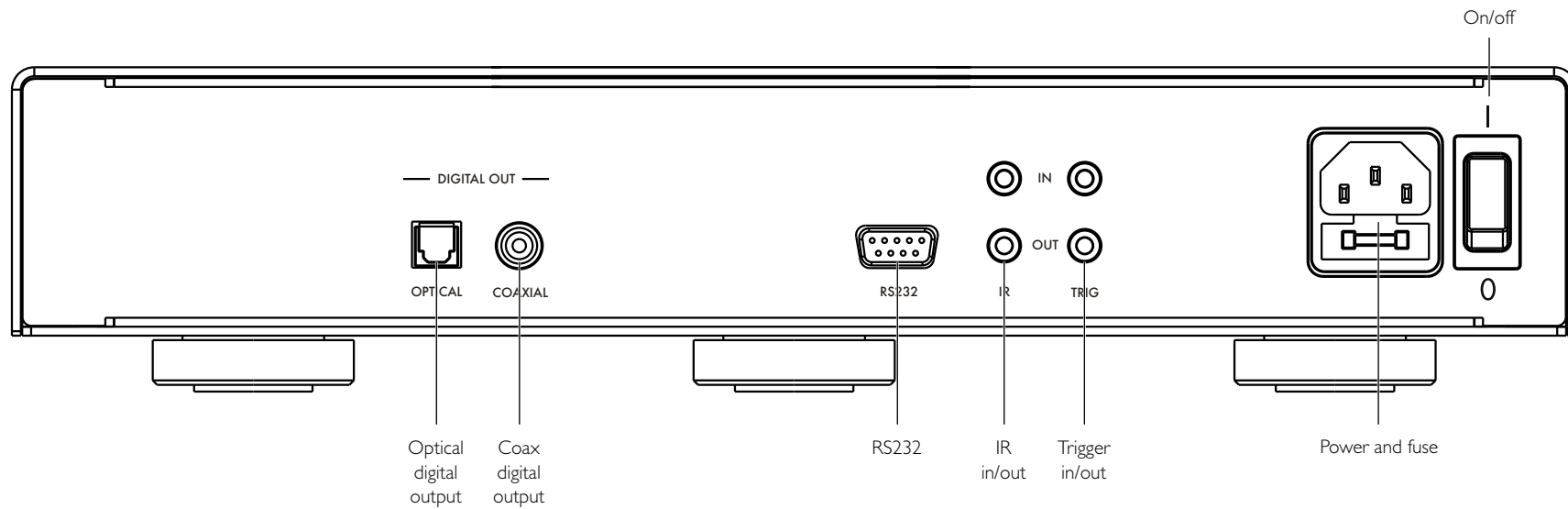

USING THE REMOTE CONTROL

Selecting DD15 mode

The remote control can operate any associated Primare products you have in your system.

To make the remote control operate the DD15

- Press the **CD SC** button once.

To make the remote control operate another product

- Press the **AMP AV**, **CD SC**, or **PRE AUX** button as appropriate.

Press once to select the product on the top line of the button, or twice to select the product on the second line.

The indicators at the top of the remote control light when pressing a button to show which mode the remote control is in.

Fitting the batteries

Before using the remote control you need to insert the two AAA cells supplied with the C25.

- Open the cover on the back of the remote control by pressing the back cover gently near the centre of the remote control, and sliding it towards the edge of the remote control.
- Insert the two batteries, with the polarity as indicated on the bottom of the battery compartment.
- Replace the cover and push until it clips into place.



Note: Replace only with 1.5V alkaline cells type AAA or equivalent.

When disposing of old batteries please be considerate to the environment.

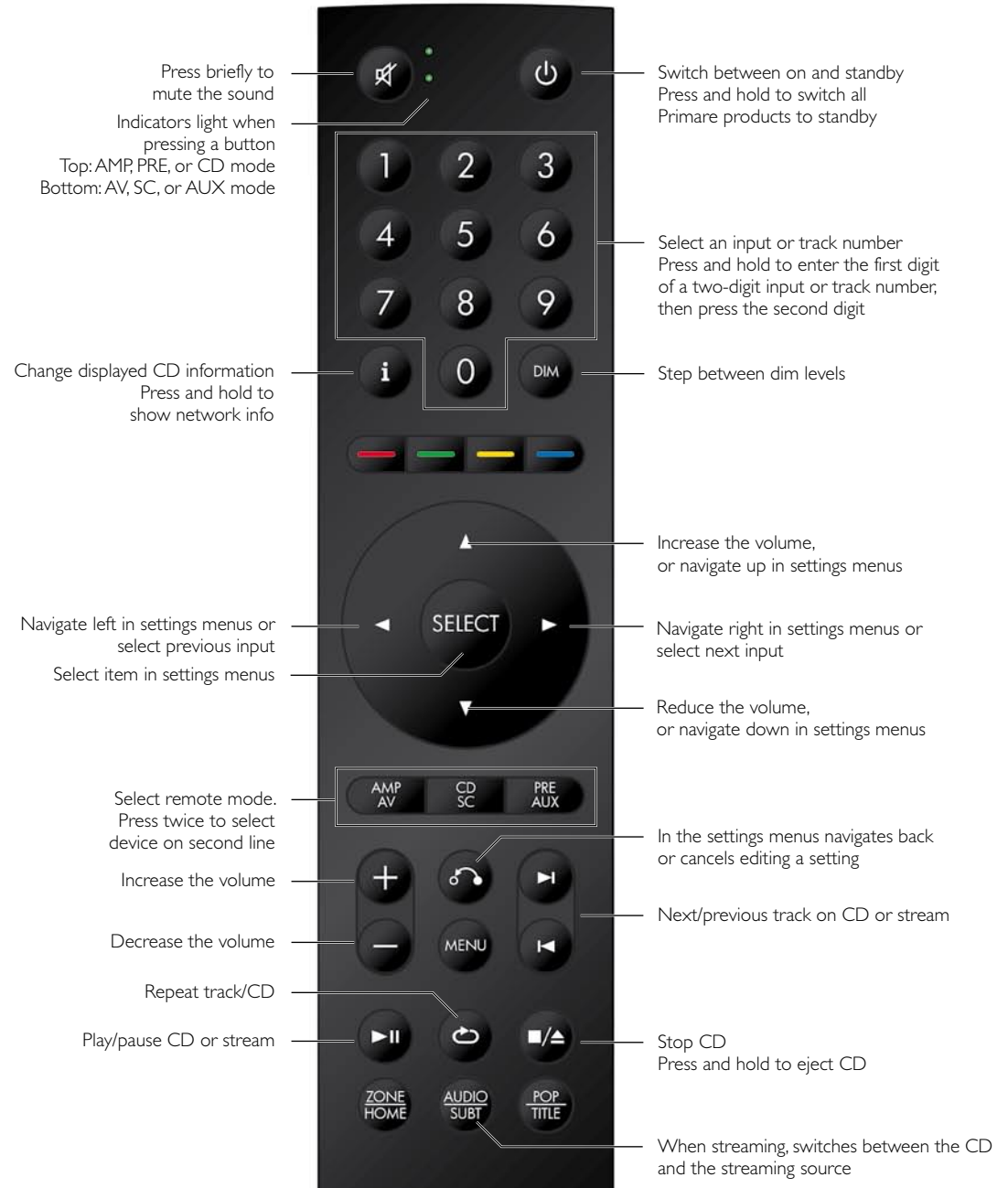

USING THE DD15

Front panel controls

Standby

Switches the DD15 to standby, or switches it on from standby.

Play/Skip

When the disc is stopped: plays the disc.

When the disc is playing: skips to the next track.

Press and hold: skips back through the tracks.

Stop/Open



When the disc is playing: pauses the disc.

When the disc is paused: stops the disc.



When the disc is stopped: ejects the CD.

Press and hold: ejects the CD.

Settings menus

Pressing  and  simultaneously displays the settings menu or exits from the menu.

In the settings menu:

Pressing  or  steps between the settings.

Holding down  selects a setting or saves an edited setting.

Holding down  navigates back or cancels editing a setting.

Playing a disc

To insert a disc

- Insert the CD into the slot with the label facing upwards.

The display shows:





READING

followed by the number of tracks and total time:



19
74:59

To play the disc

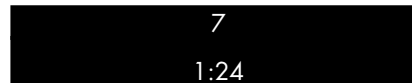

- Press the  button on the front panel, or the  button on the remote control.

While a disc is playing the display shows the current track number and the elapsed time of the current track; for example:



7
1:24

To pause the disc

- Press the  button on the front panel, or the  button on the remote control, while the disc is playing.

The display shows the pause symbol:



||

You can then resume play by pressing the  button on the front panel or the  button on the remote control.



To stop play

- Press the  button on the front panel or the remote control.



Locating a position on the disc

You can step between tracks to locate a particular track on the disc, or you can scan forwards or backwards to locate a position within a track.

To step forwards through the tracks

- Press the  button on the front panel, or press the  button on the remote control.

To step back through the tracks

- Press and hold the  button on the front panel, or press the  button on the remote control.



The front panel display shows the track number:





12

- Release the button to start playing the selected track from the beginning.

To scan through the disc

- Hold down the  or  button on the remote control to scan at 4X speed.

The display shows the position within the track.

- Release the  or  button to start playing from the position you have located

ADVANCED FEATURES

Changing the front panel display

You can choose how the time is shown on the front panel display, and change the brightness.

To change the time display

- Press the **i** button.

The display switches between the following four options:

Elapsed time for the current track

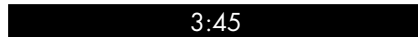
A black rectangular display showing the time 3:45 in white text.

Remaining time for the current track

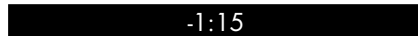
A black rectangular display showing the time -1:15 in white text.

Elapsed time for the entire disc

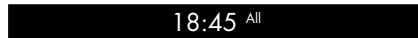
A black rectangular display showing the time 18:45 with the word 'All' in a smaller font to the right.

Remaining time for the entire disc

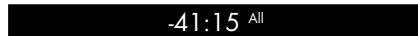
A black rectangular display showing the time -41:15 with the word 'All' in a smaller font to the right.

To change the front panel display brightness

- Press the **DIM** button on the remote control to step through the three levels of illumination and blank.

If you turn the display off it will be restored briefly when you operate any control.

The display automatically dims after ten minutes; you can adjust this delay in the settings menus; see *GENERAL SETTINGS*, page 12.

Playing a specific track

You can play from any track by entering the track number on the remote control.

To play from a specific track

- Specify the track number by pressing one of the buttons **1-9**.

To enter a two-digit track number press and hold down the button corresponding to the first digit, and then press the second digit.

To enter a three-digit track number press and hold down the **0** button, and then press the three digits.

Repeat playback

You can play the current track repeatedly, or repeat the entire disc.

To repeat the current track

While the disc is playing:

- Press the  button on the remote control.

The front panel shows **RPT**.

To repeat the entire disc

- Press the  button twice.

The front panel shows **RPT ALL**.

To turn off repeat

- Press the  button again.

The **RPT** symbol in the display will be cleared.

CONFIGURING THE SETTINGS

Using the settings menus

You can view and change the DD15 settings from the front panel, remote control, or using the Prisma app.

To display the settings menu

- Press ►/▶ and ■/▲ on the front panel simultaneously, or the **MENU** button on the remote control.

The settings menu is displayed:



To step between settings

- Press the ►/▶ or ■/▲ buttons on the front panel, or the ▲ or ▼ buttons on the remote control.

The current setting is shown highlighted.

To change a setting

- Press and hold the ►/▶ button on the front panel, or press the **SELECT** button on the remote control.

The current value is shown highlighted.

- Press the ►/▶ or ■/▲ buttons on the front panel, or the ▲ or ▼ buttons on the remote control, to change the value of the setting.

As you change it the new value is shown in the menu.

- Press and hold the ►/▶ button on the front panel, or press the **SELECT** button on the remote control, to save the value you have set.

To navigate back or cancel editing a setting

- Press and hold the ■/▲ button on the front panel, or press the ↶ button on the remote control.

To exit from the settings menu

- Press ►/▶ and ■/▲ on the front panel simultaneously, or press the **MENU** button on the remote control.

PLAYBACK SETTINGS

The **PLAYBACK SETTINGS** menu allows you to customise the auto resume feature:



AUTO RESUME

Specifies whether disc playback will start from the previously saved point.

Choose **OFF** to play from the beginning or **ON** to play from the previously saved point.

GENERAL SETTINGS

The **GENERAL SETTINGS** menu allows you to configure the general operation of the DD15:

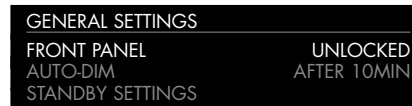

FRONT PANEL

Choose **LOCKED** to lock the front panel buttons and knobs, or **UNLOCKED** (default) to use them.

To unlock the front panel buttons use the remote control to select this menu, or remove power from the DD15 for a few seconds.

AUTO-DIM

Allows you to choose the delay for dimming the display after no user interaction, between: **AFTER 1MIN**, **AFTER 5MIN**, **AFTER 10MIN** (default), or **OFF**.

STANDBY SETTINGS

Displays the **STANDBY SETTINGS** menu to allow you to specify the standby settings.

AUTO-STANDBY automatically switches the DD15 to standby if there is no user interaction or audio from the current source for a specified delay: **AFTER 10MIN**, **AFTER 15MIN**, **AFTER 20MIN** (default), or **OFF**.

FACTORY RESET

Resets the DD15 to the factory default settings.

You are prompted to confirm. Select **YES** to proceed or **NO** to cancel.

FIRMWARE VERSIONS

Displays the **FIRMWARE VERSIONS** menu to allow you to view the versions of firmware installed.

TECHNICAL SPECIFICATION

Features

Mechanism

Philips CDM-M10

Outputs

Digital outputs

Coaxial: RCA

Optical: Toslink

PCM Sample Rate

44.1kHz

General

Control

C25 system remote control

RS232

IR in/out

Trigger in/out

Power Consumption

Standby: <0.5W

Operating: <5W

Dimensions

350 x 329 x 73 mm (wxdxh) with knobs and connectors

350 x 310 x 73 mm (wxdxh) without knobs and connectors

Weight

6.4 kg

Colour

Black or titanium

ADDITIONAL INFORMATION

These instructions help you get the best possible sound from your DD15.

Phase

The phase of the AC supply can make a significant difference to the sound.

Use the Polarity Pen supplied with the DD15 to verify which pin is live on your AC power cable.

Ensure that the live pin of the AC power cable is connected to the left-hand pin of the power connector, viewed from the back panel:

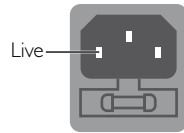

Burn-in

Your Primare will start to sound best after an initial burn-in of approximately 24 hours.

You will notice a further smaller improvement in sound quality for at least another 3 days' playing.

RS232 and trigger

The RS232 input allows you to connect the DD15 to a controller system. Use a twisted (null modem) cable. For more information contact Primare at info@primare.net or visit www.primare.net.

The Trigger output allows the DD15 to be switched on by other devices, such as an I15.

Using the DD15 with an I15

Your DD15 is an ideal companion to the Primare I15 CD Prisma Integrated Amplifier. For best results link the two products together as follows using the two cables supplied with the DD15:

To connect the trigger cable

The Trigger cable ensures that the I15 switches on, or to standby, when you operate the Φ button on the front panel of the DD15.

- Connect the Trigger cable from the DD15 TRIG OUT to the I15 TRIG IN.
- Configure the I15 to **TRIG ON**.

Factory reset

Press and hold the Φ standby button on the front panel to display the main firmware version number.

Press and hold the Φ standby button on the front panel for 10 seconds to perform a factory reset of the DD15.

You can also do a factory reset from the Prisma app, or from the **GENERAL SETTINGS** menu; see *GENERAL SETTINGS*, page 12.

INDEX

A

Auto-dim (settings menus) 12

B

Back panel 8

Balanced outputs 8

D

Digital outputs 8

Disc

Ejecting 10

Inserting 10

Locating a position 10

Pausing 10

Playing 10

Scanning 10

E

Ejecting a disc 10

F

Factory reset 14

Firmware (settings menus) 12

Front panel (settings menus) 12

Front panel controls 10

Front panel display, changing 11

G

General settings menu 12

I

Inserting a disc 10

IR input 8

L

Locating a position on a disc 10

M

Menus

General settings 12

Playback settings 12

O

Outputs 8

P

Pausing a disc 10

Phase 14

Playback settings menu 12

Playing a disc 10

R

Remote control 9

Fitting batteries 9

Repeat playback 11

RS232 input 8, 14

S

Scanning through a disc 10

Specific track, playing 11

Standby settings (settings menus) 12

T

Trigger output 8, 14

P R I M A R E

THE SOUND AND VISION OF SCANDINAVIA SINCE 1986

LIMSTENSGATAN 7,
216 16 LIMHAMN, SWEDEN

More information at primare.net

