

# CAR KEYBOARD CONTROLLER

# USER INSTRUCTION

## USE/INSTALLATION

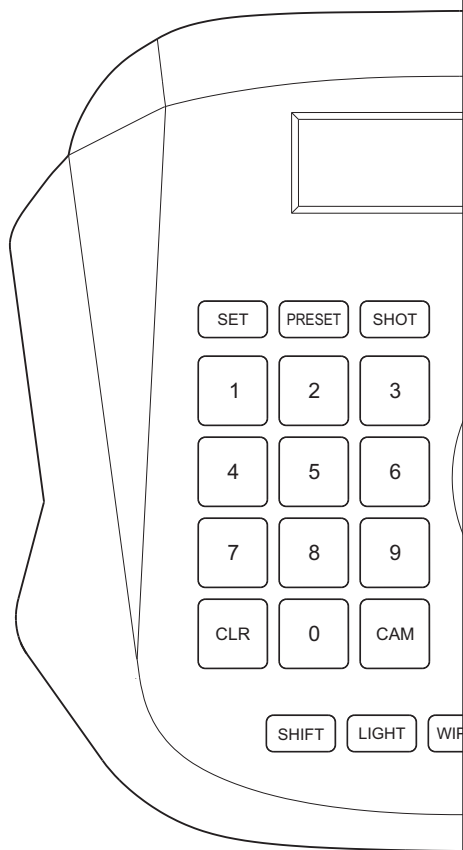



## Preface

Thank you for purchasing our products, if you have any questions or needs, please feel free to contact us. In use before the installation, please check whether your product fittings is complete, if appear the phenomenon such as packing accessories missing, please contact the local dealer.

This manual might be not accurate technically or contains some minor typo errors. The contents in this manual about p Introduction description and program might be updated on an un-periodical.

### Cautions:

- >The LCD is fragile, no crush or long-exposed under strong light.
- >Operation knob is fragile, please make sure product is packed with original packing material when you send it back for reparation.
- >The keyboard controller should be work in specified range of temperature and humidity.
- >Please follow the connecting method defined in this manual.

### List of items :

Name	Quantity	Units	Remarks
2PIN Isobar	1	PCS	
DC-12VPower	1	PCS	INPUT: 100-240VAC~50/60HZ
User Manual	1	PCS	
Certificates	1	PCS	
Warranty cards	1	PCS	

### Statement

Described in this manual content may now use the version of the difference between with you, if you are using this manual in question, please contact our technical support for help.

This manual content will be updated on a regular basis, the company has reserves the right to without prior notice.

<b>Chapter One : product's introduction</b> .....	3
1.1 Keyboard controller introduction.....	3
1.2 Features of keyboard controller.....	3
1.3 Basic function of keyboard controller.....	3
1.4 application scenarios.....	3
1.5 Keyboard controller parameters.....	4
1.6 product's size.....	4
<b>Chapter Two :product ' s service</b> .....	5
2.1 Control keys function.....	5
2.2 The LCD screen.....	5
2.3 Operation knob control.....	6
2.4 Introduction to the connection part of keyboard controller.....	6
<b>Chapter Three :Introduction to control keyboard controller operations</b> .....	6
3.1 Introduction to single key and combined keys.....	6
3.2 Detailed introduction to combined keys.....	7
<b>Chapter Four: Parameter Settings and the connection diagram</b> .....	8
4.1 Keyboard controller system parameter Setup.....	8
4.2 Keyboard controller controls parameter Setup.....	8
4.3 Keyboard controller parameter setup framework.....	8
4.4 Typical connecting diagram.....	9
<b>Chapter Five :FAQs</b> .....	10
5.1 FAQs.....	10
<b>Chapter Six:Appendix</b> .....	10
6.1 RS485 bus wiring.....	10

### 1.1 Keyboard controller introduction

Keyboard controller is a requisite device for compact monitor system, which controls the positioning of all front speed dooms, mounting bracket and electric lens, and also the out-door shield brush, auxiliary lamp.

Usually keyboard controller consists of many number keys and function keys. Number keys are used to control speed dooms or decoder. Function keys are used to control front devices. LCD on console display control codes and working status of each monitor station. one system has only one mater control board, but many slave control board, which are usually located in the respective office to achieve remote control of the entire tele monitor control system.

### 1.2 Features of keyboard controller

- 1) Devices connected to RS485 bus can be set with different protocol and baud rate.
- 2) Update new program on line. According to the protocol and control codes provided by customer, compile update program. Customer can update firmware by connecting to keyboard controller to computer via RS485 bus.
- 3) Address of the current control protocol, baud rate, according to direct and clear.
- 4) All parameters can be set via control key operations.

### 1.3 Basic function of keyboard controller

- 1) RS485 control bus can control maximum 255 front devices (depending on the setting of communication chipset), The largest 128 devices in parallel at the same time
- 2) Standard RS485 I/O ports are all lightning-proof , strong for interference ,Standard communication distance is as long as 1200m.
- 3) Multiple protocol available for speed doom control.
- 4) Key sound ON/OFF
- 5) Progressive speed dome control
- 6) LCD display, multi-dimension control knob control

### 1.4 Application scenarios

The keyboard can be applied to install how speed doom places such as schools, hospitals, hotels, residential, factory, workshop, etc., between devices are free to switch control, convenient and quick.

## Chapter One : product's introduction

### 1.5 Keyboard controller parametersa:

Item	Parameters
Power supply	DC12V/1A±10% / 50HZ
Temperature	- 10~ 55℃
Humidity	≤ 90%RH( No cream node)
Communication	RS485 Half - duplex
Baud Rate	1200bps、2400bps、4800bps、9600bps
Interface	2 PIN Pressure Line terminals
That way	the LCD screen
Exteriorsize	158*150*107 mm

### 1.6 product's size

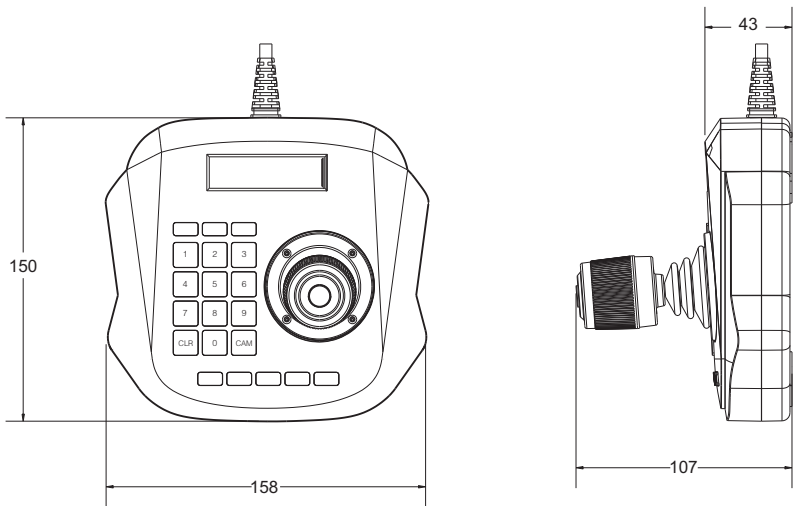

## 2.1 Control keys function

**【SETUP】** Press for 3sec to set up key parameters.

**【PRESET】** Preset the original position of speed doom. This key should be used together with number key .

**【SHOT】** Recall the preset position of speed doom. This key should be used together with number key .(Some special function are achieved via recalling preset, e.g. Recall speed doom menu, recall integrated menu, pattern patrol, pattern scan, linear scan, et.)

**【0】 ~ 【9】** number key:0、1、2、3、4、5、6、7、8、9

**【CLR】** Back to previous menu.

**【CAM】** Address selection key . Select decoder address, PTZ address.

**【CUT】** Switch the focus and aperture function

**【LIGHT】** The lights turned on or off.

**【WIPER】** Wipers open or closed.

**【FOCUS+/IRIS+】** FOCUS+ : Manual focus on distant object. IRIS+:Increase aperture manually. By **【CUT】** key switch the key function

**【FOCUS-/IRIS-】** FOCUS- : Focus on closer object. IRIS-:Downsize aperture. By **【CUT】** key switch the key function

**【ZOOM+】** Turning to the left of remote sensing is zoom+ function . The lens magnification increase, amplify surveillance target

**【ZOOM-】** Turning to the right of remote sensing is zoom- function. The lens magnification decreased, expanding the scope of the monitor

**【ENTER】** Button on the remote sensing is the enter button, Enter confirm input

## 2.2 The LCD screen





All key operations will be displayed on LCD instantly. LCD will switch to Low-Power mode if the smart controller does not receive any input for more than 30 seconds.

Screen will return to the initial state





## Chapter two :Product Use

### 2.3 Operation knob control





When control speed doom and mounting plate:

Operating	Output Control	Operating	Output Control	Operating	Output Control	Operating	Output Control
	Upward		Downward		Left		Right

When control Setup of keyboard controller:

Operating	Output Control	Operating	Output Control	Operating	Output Control	Operating	Output Control
	Menu turned up		Menu turned down		Parameter of the left		Parameter of the right

When control menu for speed doom:

Operating	Output Control	Operating	Output Control	Operating	Output Control	Operating	Output Control
	Menu turned up		Menu turned down		Esc or not save set		Esc or save set

### 2.4 Introduction to the connection part of keyboard controller

1 2-pin port , 1DC-12V port



The following map:

Item	Marked	Interface	Description
1	PTZ – CON	Control output(Ra/Rb)	Connect to speed doom RS485 bus(Ta) to RS485+, (Tb) to RS485-
2	DC – 12V	DC power input	DC power input



### 3.1 Introduction to single key and combined keys

**3.1.1 Single key:** When single key is pressed, the corresponding PTZ will respond.

Single key operations include: **【ZOOM+】 【ZOOM-】 【IRIS+】 【IRIS-】 【LIGHT】 【WIPER】** 。

**3.1.2 Combined key:**

Combined key operations mean 2 or more keys, or key and knob are pressed, the corresponding PTZ will Action change operation.

The operations include : **【PRESET】 【SHOT】 【CAM】** 。

### 3.2 Detailed introduction to combined keys

**3.2.1 Enter PTZ mode:**

If LCD display 

CAM:XXX
P:XXX B:XXX

 indicating the control key board is working in PTZ mode,if no ,please **【CLR】** toback to PTZ mode.

**3.2.2 Choose PTZ address:**

In PTZ mode , input the PTZ address number to control ,then press **【CAM】** 。

**3.2.3 Set and recall preset point:**

Set up :Choose the address of speed doom to set or recall.

Operate knob to move to corresponding point, and zoom lens to specified position, then press the preset point to set, then press **【PRESET】** 。

Recall : Input the preset point to recall ,then press **【SHOT】** 。

### 4.1 Keyboard controller system parameter Setup

#### 4.1.1 System parameters include :

password, restore default settings, key tone ON/OFF , key ID Setup ,keylock,etc.

#### 4.1.2 The operations are:

In normal mode press Setup for 3sec , LCD will display : **INPUT PW: ----** ,

Input password(default 8888) ,press **【ENTER】** ,LCD display :

**SYSTEM SET** and **CAMERA SET** .

Select **SYSTEM SET** ,then press **【ENTER】** key, LCD will display panel each system function settings ( **LANGUAGE** , **PW SET** , **SOUND SET** ,

**BACKLIGHT** , **DEFAULT** , **KB INFO** ), rocker to move the cursor to

move up and down on the function of the need to set up, press **【ENTER】**

key to rocker arm around mobile corresponding parameter choice, then

press **【ENTER】** key to be set up need to set parameters. Press **【CLR】**

key to exit to control condition.

### 4.2 Keyboard controller controls parameter Setup

Select **CAMERA SET** ,then press **【ENTER】** key, LCD will display

**CAM: XXX** and **P: XXX** , move the cursor to **CAM: XXX** , rocker around

mobile can choose fast ball address need to change the agreement, rocker

arm moves down again, the address will be confirm, move the cursor to the

**P: XXX** , rocker around mobile to select protocol, press **【ENTER】** key to

confirm.

Continue to move down rocker, LCD display on **CAM: XXX** and **B: XXX** ,

move the cursor to **CAM: XXX** rocker move around can choose fast ball

address need to change the baud rate, rocker arm moves down again, then

confirm the address, move the cursor to **B: XXX** , rocker around mobile to

select baud rate, press **【ENTER】** key to confirm.

## 4.3 Keyboard controller parameter setup framework

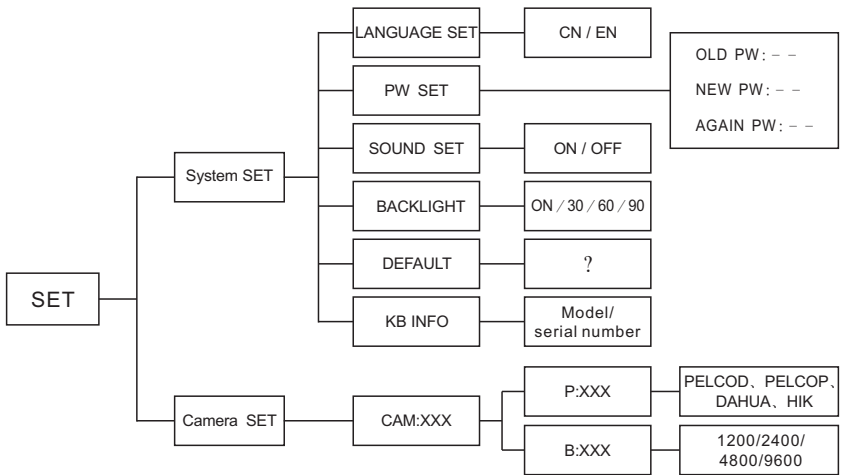

## 4.4 Typical connecting diagram

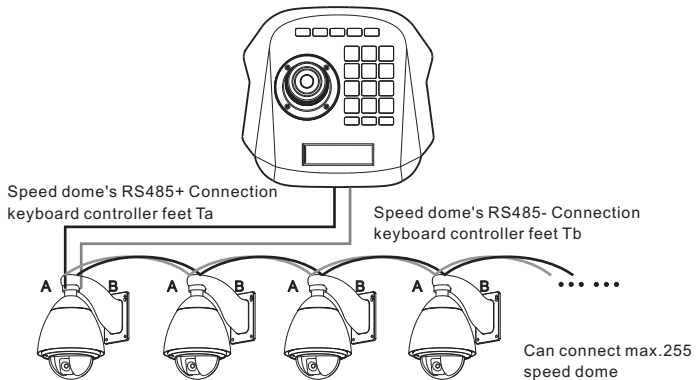

### Introduction:

Control code output:speed doom's RS485+ should be connected to Ta of keyboard controller,RS485- to Tb.

### 5.1 FAQs

Symptom	Symptom Analysis	Methods
keyboard controller cannot control the speed doom.	check the hardware: RS485.	Step 1: RS485 A and B is reversed. Step 2: Check RS485 cable continuity is OK or not.
	Check the software settings: keyboard controller and speed doom address, protocol, baud rate.	Step 1: check the current protocol and baud rate is correct or not . Step 2: Restore the settings to default setting and reset.
Some speed dooms can be controlled but some not.	Check hardware	Check the continuity of each branch cable
	Check software settings	Check the protocol and baud rate of each address code
	Might be the connecting diagram	Step1: connect to RS485 a 120Ω at far end. Step2: Install RS485 hub at te connect of figure star.
One operation of keyboard controller, a few speed dooms respond simultaneously.	Check the address code of front device.	Check whether those speed doom that respond simultaneously have the same address code or not .Set different address.
No key tone.	Turn on key tone in system settings.	

## 6.1 RS485 bus wiring

### Transmission Range:

when use twisted pair cable as the communication cable, according to different baud rate, there exists different max. transmission range: When baud rate is 2400bps, the transmission range could be 1800m, when baud rate is 19200bps, the transmission range could be 600m. The max. Transmission range will be shortened correspondingly when thinner communication cable is used or in intense electromagnetism interface environment or many devices are connected on the bus.

### Connection Mode and Termination Resistor:

RS485 bus standard request use daisy chain connection mode between each device and two point must be connected with a  $120\Omega$  termination resistor . The distance of two balanced lines should not exceed 7m.

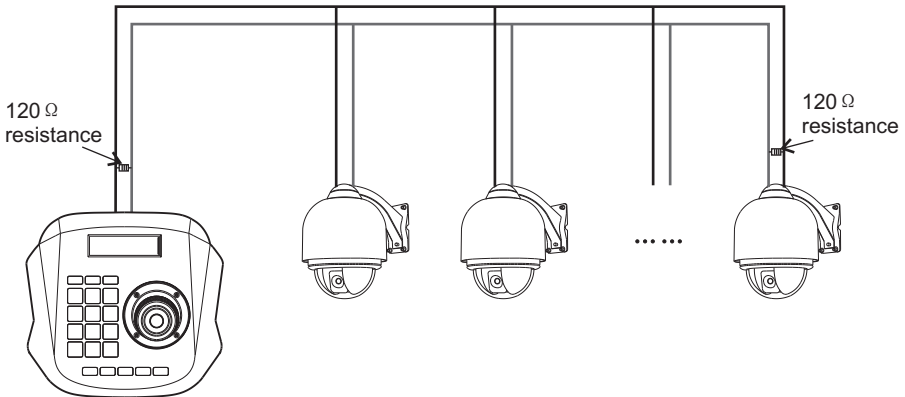

### Problems in Practical Application:

In practical project, consumers usually use star type connecti on mode, at this time termination resistor must be connected to the devices between which the line distance is farthest. But as this connection mode don't meet RS485 standard requirement, so, when the line distance between each device is further, it easily occur problems that signal reflection and decreased an ti-interference ability etc. Cause the reliab ility of control signal drop. In this condition, we suggest consumers use RS485 distributor. It can effectively change the star type chain connection into the connection mode that accord with RS485 standard to avoid problems. Enhance the reliability of the communication.

