

DIGITAL PIANO

Owner's Manual

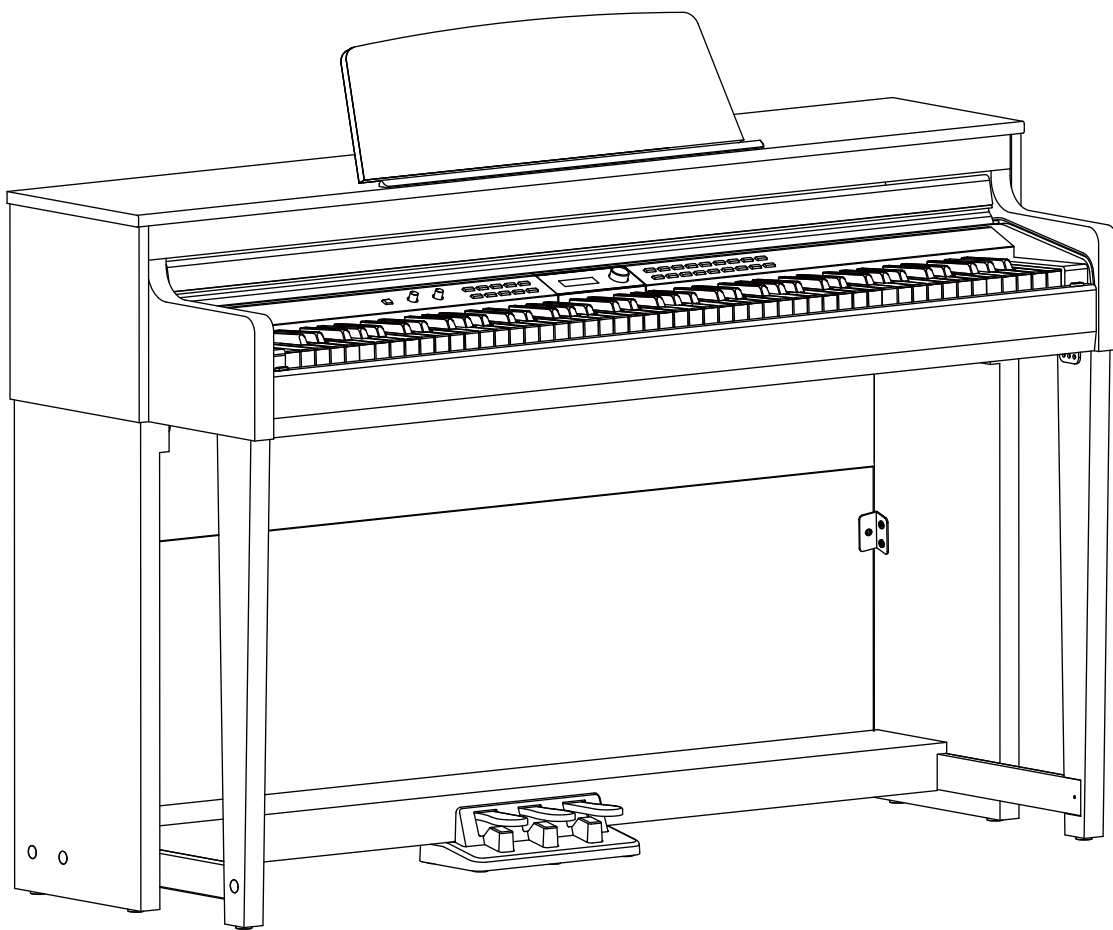

INFORMATION FOR YOUR SAFETY!

THE FCC REGULATION WARNING (for USA)

This equipment has been tested and found to comply with the limits for a Class B digital device, pursuant to Part 15 of the FCC Rules.

These limits are designed to provide reasonable protection against harmful interference in a residential installation. This equipment generates, uses, and can radiate radio frequency energy and, if not installed and used in accordance with the instructions, may cause harmful interference to radio communications. However, there is no guarantee that interference will not occur in a particular installation. If this equipment does cause harmful interference to radio or television reception, which can be determined by turning the equipment off and on, the user is encouraged to try to correct the interference by one or more of the following measures:

- Reorient or relocate the receiving antenna.
- Increase the separation between the equipment and receiver.
- Connect the equipment into an outlet on a circuit different from that to which the receiver is connected.
- Consult the dealer or an experienced radio/TV technician for help.

Unauthorized changes or modification to this system can void the user's authority to operate this equipment.

CAUTION

The normal function of the product may be disturbed by Strong Electro Magnetic Interference. If so, simply reset the product to resume normal operation by following the owner's manual. In case the function could not resume, please use the product in other location.

PRECAUTIONS

PLEASE READ CAREFULLY BEFORE PROCEEDING

Please keep this manual in a safe place for future reference.

Power Supply

Please connect the designated AC adaptor to an AC outlet of the correct voltage.

Do not connect it to an AC outlet of voltage other than that for which your instrument is intended.

Unplug the AC power adaptor when not using the instrument, or during electrical storms.

Connections

Before connecting the instrument to other devices, turn off the power to all units. This will help prevent malfunction and / or damage to other devices.

Location

Do not expose the instrument to the following conditions to avoid deformation, discoloration, or more serious damage:

- Direct sunlight
- Extreme temperature or humidity
- Excessive dusty or dirty location
- Strong vibrations or shocks
- Close to magnetic fields

Interference with other electrical devices

Radios and televisions placed nearby may experience reception interference. Operate this unit at a suitable distance from radios and televisions.

Cleaning

Clean only with a soft, dry cloth.

Do not use paint thinners, solvents, cleaning fluids, or chemical-impregnated wiping cloths.

Handling

Do not apply excessive force to the switches or controls.

Do not let paper, metallic, or other objects into the instrument. If this happens, remove the electric plug from the outlet. Then have the instrument inspected by qualified service personnel.

Disconnect all cables before moving the instrument.

Panel & Display Description

Front Panel.....	4
IO Panel.....	5
Pedal.....	5
LCD Display.....	5

Setup

Setup Guide.....	6
------------------	---

Connections

Connecting a Pair of Headphones.....	9
Connecting an Audio Equipment.....	9
Connecting an MP3/CD Player.....	9
Connecting a Computer or a MIDI Device.....	9

Quick Start

Power Supply.....	10
Adjusting the Master Volume.....	10
Adjusting the Voice Brilliance.....	10
Playing the Demo Songs.....	10
Playing the Voices.....	11
Playing the Styles.....	11
Playing the Songs.....	11

Advanced Use

Playing the Voices.....	12
Playing a Voice.....	12
Playing Two Voices Simultaneously - Dual.....	12
Playing Different Voices with Both Hands - Lower....	12
Playing Voice Demo.....	13
Transpose.....	13
Piano Mode.....	13
Twinova.....	14
Metronome.....	14

Auto Accompaniment

Selecting a Style.....	15
Playing the Style.....	15
Fill A/B.....	15
Tempo.....	15

Song

Listening to the Songs.....	16
Practise the Songs.....	16

MIDI Recording

Record with Style Accompaniment.....	17
Record with Song Accompaniment.....	17

Audio Recording.....

18

Connecting USB Flash Drive

Play.....	18
Save.....	19
Load.....	19
Format.....	19

Function Menu

Tune.....	21
Octave.....	21
Touch.....	21
Volume.....	21
Time Signature.....	21
Speaker EQ.....	22
String Resonance.....	22
Reverb.....	22
Chorus.....	23
MIDI OUT Channel.....	23
Song Looping.....	23
Auto Power Off.....	23
System Time.....	24
Restore Factory Setting.....	24

Working with a Computer or a Smart Device

Connecting a Computer.....	25
Connecting a Smart Device.....	25

Troubleshooting.....

26

Specifications.....

26

Appendices

Voice List.....	27
Style List.....	28
Song List.....	29
Demo List.....	30
MIDI Implementation Chart.....	31

Panel Description

Front Panel

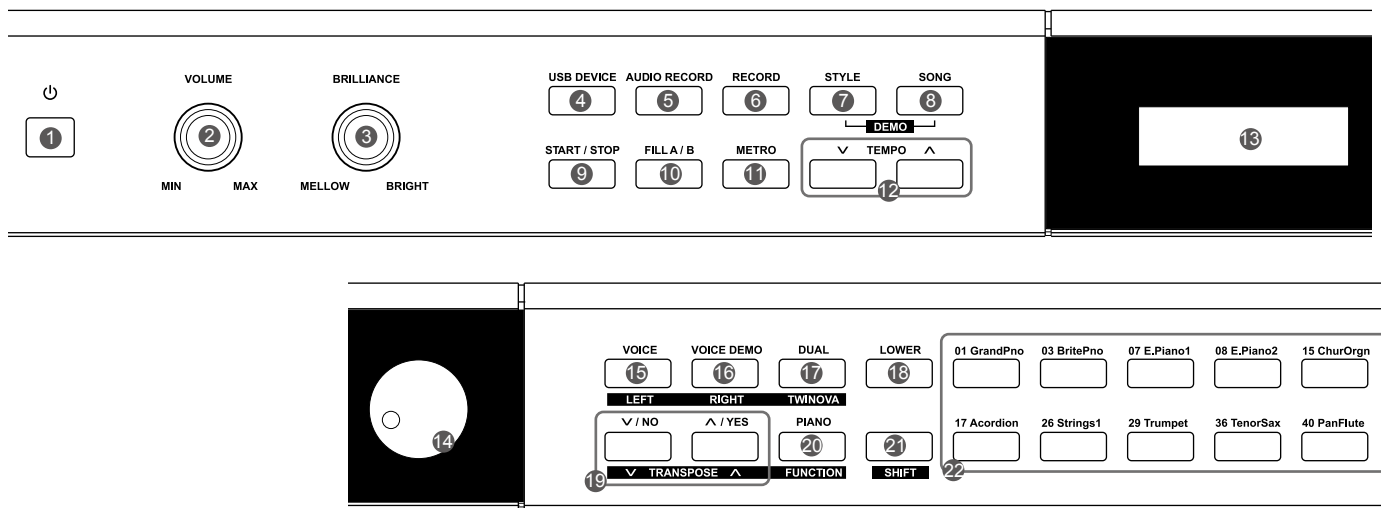

1. [POWER] Switch

Turn the power on or off.

2. [VOLUME] Knob

Adjust the master volume.

3. [BRILLIANCE] Knob

Adjust the voice brilliance.

4. [USB DEVICE] Button

Enter the Play menu or the USB flash drive menu.

5. [AUDIO RECORD] Button

Enter the audio recording mode.

6. [RECORD] Button

Enter the MIDI recording mode.

7. [STYLE] Button

Enter the style mode.

8. [SONG] Button

Enter the song mode.
Press both [STYLE] and [SONG] buttons simultaneously to enter the demo mode.

9. [START/STOP] Button

Start/stop playing a song or style.

10. [FILL A/B] Button

Play the fill-in pattern A or B.

11. [METRO] Button

Turn the metronome on or off.

12. [TEMPO] Button

Adjust the current tempo.

13. LCD Display

Display all parameters and values related to the current operation.

14. [Data Dial]

Adjust the value.

18. [LOWER] Button

Turn the lower function on or off.

21. [SHIFT] Button

Press and hold it to access secondary functions of other buttons.

22. VOICE Select Buttons

Select directly a preset voice.

When [SHIFT] is released:

15. [VOICE] Button

Enter the voice mode.

16. [VOICE DEMO] Button

Start or stop playing the voice demo.

17. [DUAL] Button

Turn the dual function on or off.

19. [+ / YES] / [- / NO] Button

Adjust the value.

20. [PIANO] Button

Turn the piano mode on or off.

When [SHIFT] is pressed:

15. [LEFT] Button

Turn on or off the left hand melody of a preset song, so as to practise the left hand part.

16. [RIGHT] Button

Turn on or off the right hand melody of a preset song, so as to practise the right hand part.

17. [TWINOVA] Button

Turn the twinova function on or off.

19. [TRANSPOSE-] / [TRANSPOSE+] Button

Adjust the transpose value.

20. [FUNCTION] Button

Enter the function menu.

IO Panel

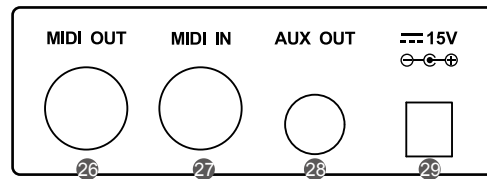
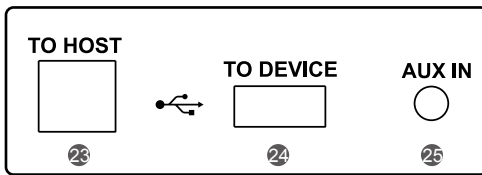

23. USB Jack

Connect to a computer, a smart device or a USB host device.

24. USB Port

Connect a USB flash drive.

25. AUX IN Jack

Connect an external audio source, such as an MP3 or CD player.

26. MIDI OUT Jack

Transmit MIDI messages to an external MIDI device.

27. MIDI IN Jack

Receive MIDI messages from an external MIDI device.

28. AUX OUT Jack

Connect an external audio equipment.

29. DC IN Jack

Connect the DC power adaptor.

Pedal

30. Soft Pedal

When you step on the soft pedal, all notes played on the keyboard will have a softer effect.

31. Sostenuto Pedal

When you step on the sostenuto pedal, the notes played before you step on the pedal will have a sustain effect.

32. Sustain Pedal

When you step on the sustain pedal, all notes played on the keyboard will have a longer sustain. It also supports the half-pedal operation. Performing with the sustain pedal will achieve a smooth effect.

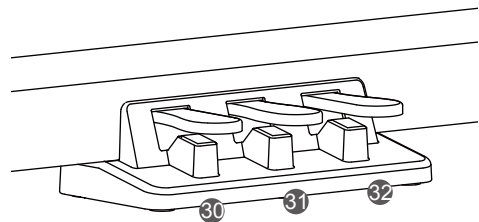

Display

1. Voice Layer and Voice Number

2. Octave Value

3. Transpose Value

4. Tempo

5. Voice Name

6. Measure and Beat

7. Record Indicator

8. Time Signature



Setup

This section contains information about setting up your instrument and preparing to play. Please go through this section carefully before turning the power on.

Component Guide

Before proceeding to assemble the stand, please get a Philip's screwdriver (not supplied).

Make sure you have the following parts in the package.

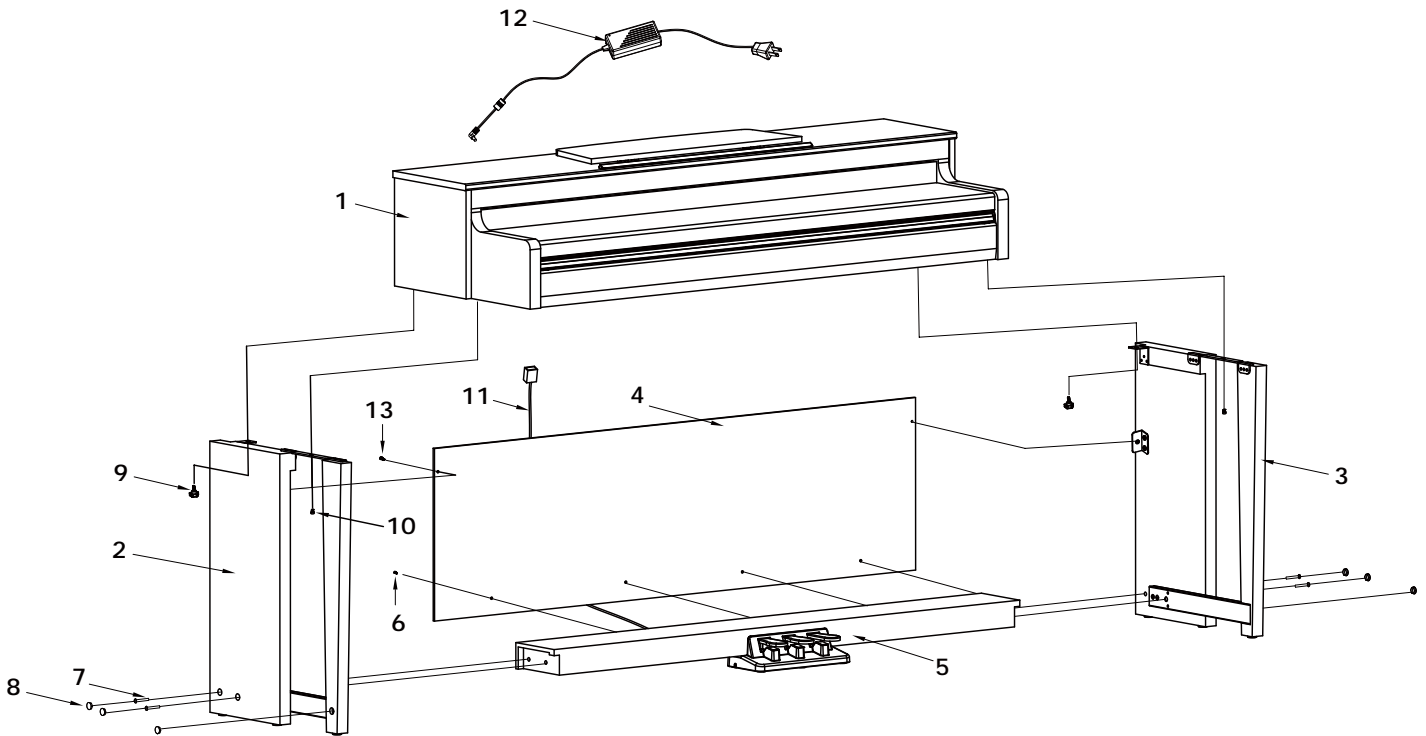

1.	Piano body
2.	Left stand component
3.	Right stand component
4.	Back board
5.	Pedal box
6.	Screws 4x15BA (4PCS)
7.	Screws M6x50 (4PCS)
8.	Screw caps (6PCS)
9.	Hand screws (2PCS)
10.	Screws M6x18 (2PCS)
11.	Pedal cable
12.	AC power adaptor
13.	Screws M6x12 (2PCS)

Setup Guide

- A. Put the pedal box in between the left and right stand components, use 4 pieces of screws to stable the left and right stands on to pedal unit, and covered by 6 pieces of screw caps.

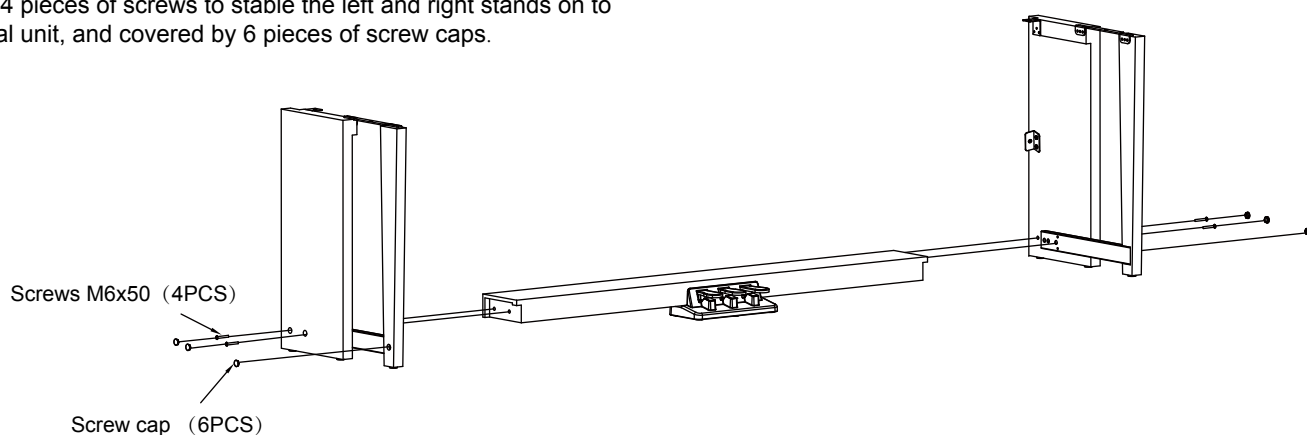

- B. Use 4 pieces of screws 4x15 BA & 2 pieces of screws M6x12, make back board fixed on the pedal box, left and right stand component.

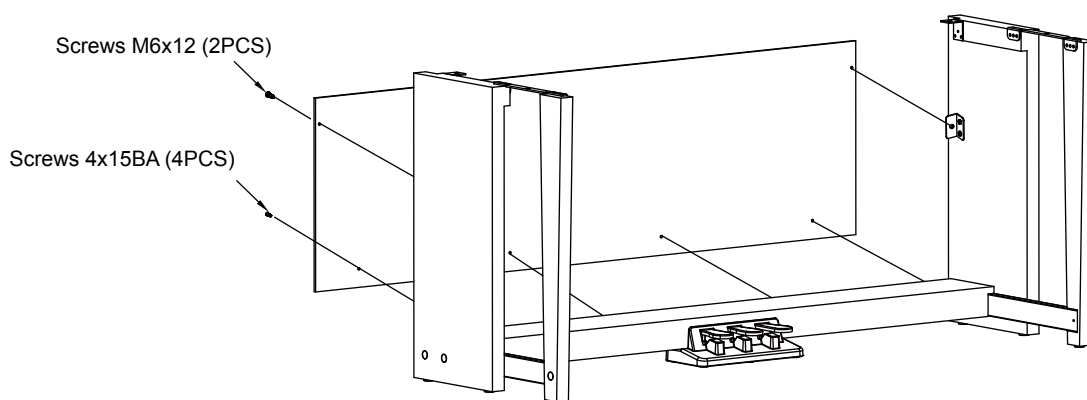

- C. Put the piano body on the top of the assembly finished by part B, then Use 2 pieces of Hand screws and 2 pieces of M6x18 screws to stable.

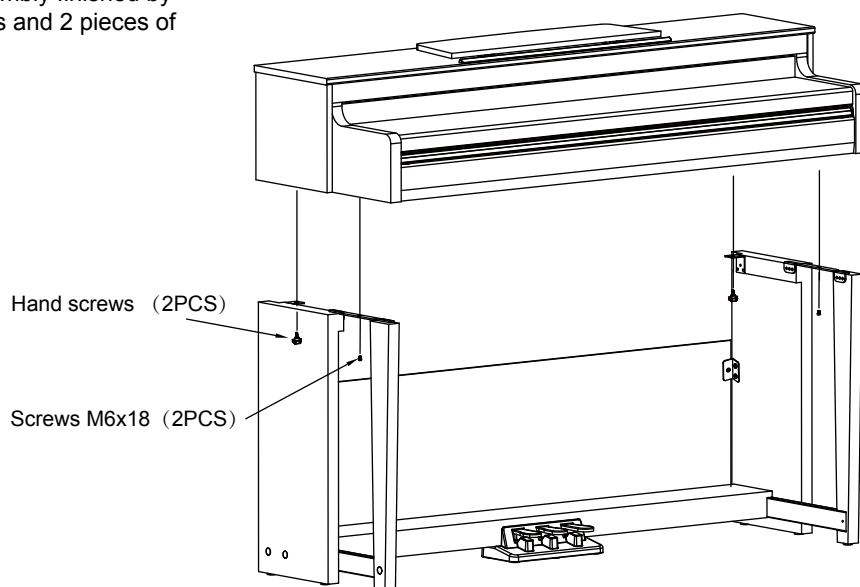

Setup

D. Connect pedal cable with the piano body bottom pedal jack, and connect the AC power adaptor to the DC in terminal.

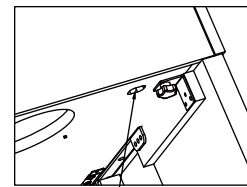
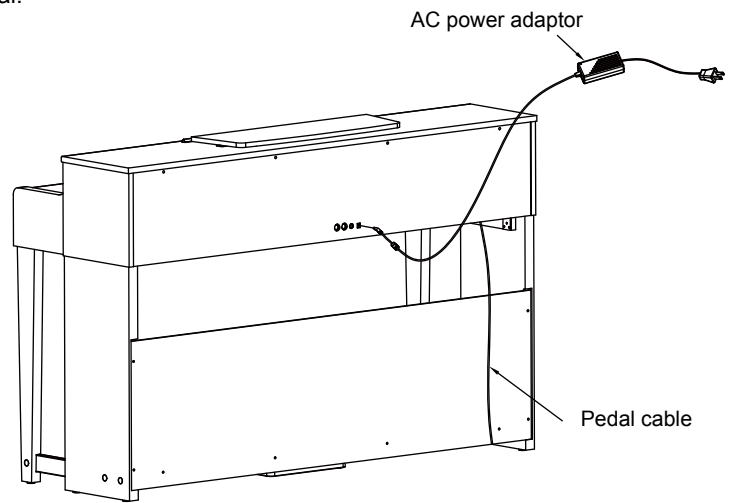

Connecting a Pair of Headphones

Plug a pair of standard stereo headphones to the PHONES jack for private practice or late-night playing.

Jack 1: When a pair of headphones is plugged into Jack 1, sound can be heard from both headphones and speakers.

Jack 2: When a pair of headphones is plugged into Jack 2, the internal speakers are automatically shut off, sound can only be heard from the headphones.

Note:

To avoid the risk of hearing loss, do not listen with headphones at high volume level for a long period of time.

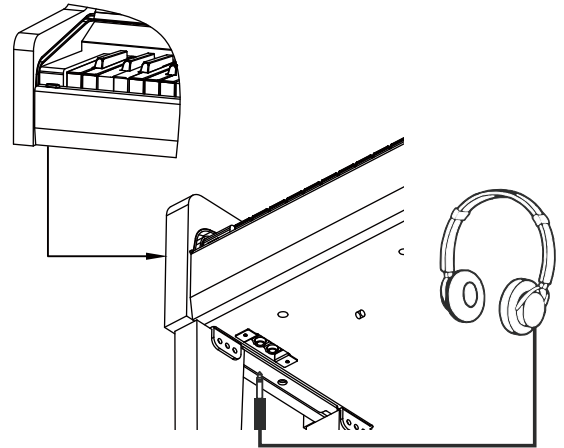

Connecting an Audio Equipment

The rear-panel AUX OUT jack delivers the output of the instrument to an external audio equipment such as a keyboard amplifier, a stereo sound system, a mixing console, or a tape recorder.

Use an audio cable to connect the AUX OUT jack to the AUX IN jack of the external audio equipment.

Notes:

1. Turn off the power to all units before connecting the external equipment.
2. To avoid damaging the speakers, please set the volume level to minimum before turning on the power.

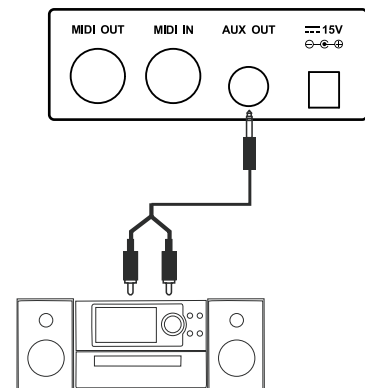

Connecting an MP3/CD Player

The rear-panel AUX IN jack receives audio signals from an external audio source such as an MP3 or a CD player.

Use an audio cable to connect the AUX IN jack to the AUX OUT jack of the MP3/CD player. The input signal will be mixed with the internal signal, allowing you to play along.

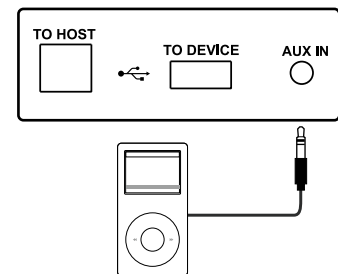

Connecting a Computer or a MIDI Device

MIDI OUT Jack

Use a standard MIDI cable to connect the MIDI OUT jack of the instrument to the MIDI IN jack of an external device. The instrument will transmit MIDI messages to the external device and work as a MIDI controller.

MIDI IN Jack

Use a standard MIDI cable to connect the MIDI IN jack of the instrument to the MIDI OUT jack of an external device. The instrument will receive MIDI messages from the external device and work as a sound source.

USB Jack

Use a standard USB cable to connect the USB jack of the instrument to the USB port of a computer. You can transmit MIDI messages between the instrument and the computer.

You can save the keyboard performance to the computer or use the speaker system of the instrument to play back music on the computer.

Note:

Do not set the USB device to be input and output simultaneously when setting the software on computer. Otherwise, the sound will be overlapped when playing the keyboard.

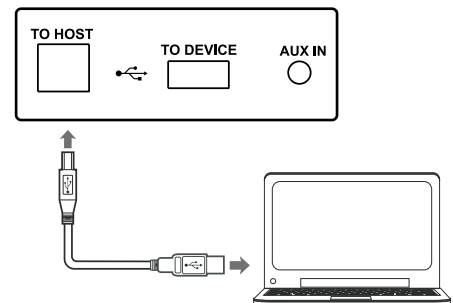

Quick Start

Power Supply

1. Turn off the instrument and turn down the volume before connecting to power supply.
2. Connect the AC adaptor to the DC IN jack of the instrument.
3. Plug the AC adaptor to an AC outlet.
4. Press the [POWER] button, LCD shows “Grand Piano”, which indicates the instrument is powered on.
5. If you are ready to turn off the instrument, press and hold the [POWER] button until the LCD lights off.

Notes:

1. The instrument will automatically shut down after 30 minutes if it is not used. Please refer to Auto Power OFF.
2. For your safety, please unplug the instrument when it is not in use or during a thunderstorm.

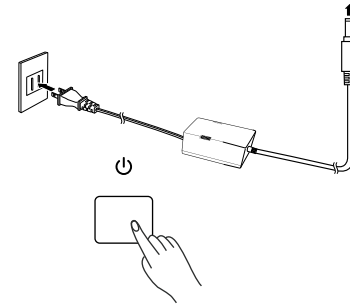
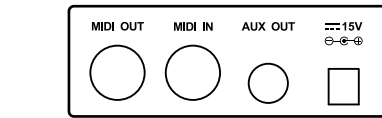

Adjusting the Master Volume

Rotate the [VOLUME] knob clockwise to increase the master volume or anticlockwise to decrease it. You can use the knob to set the desired volume level.

Note:

If the keyboard keeps silent, check if the volume is set to minimum or if headphones are plugged into Jack 2.

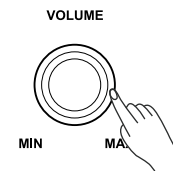

Adjusting the Voice Brilliance

Rotate the [BRILLIANCE] knob clockwise to make the voice sound brighter, or anticlockwise to make it sound mellow. You can use the knob to set the desired brilliance level.

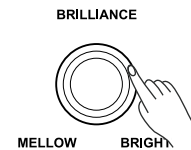

Playing the Demo Songs

The instrument features a number of beautiful demo songs. Please refer to the Demo List.

1. Press both the [STYLE] and [SONG] buttons simultaneously to enter the demo mode. It starts playing all demo songs in a loop. The LCD shows the current demo name and number.
2. Use the [Data Dial] or [+ / YES] / [- / NO] button to select a demo song.
3. Press the [START / STOP] button to stop and exit the demo mode. Or press again both the [STYLE] and [SONG] buttons to stop and exit the demo mode.

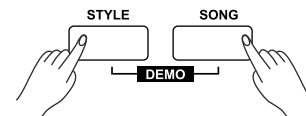

Playing the Voices

The instrument features a variety of exceptionally realistic voices. Please refer to the Voice List.

1. Press the [VOICE] button to enter the voice mode. The LCD shows the current voice name and number.
2. Use the [Data Dial] or [+ / YES] / [- / NO] button to select a desired voice. Or press the VOICE select buttons to select a preset voice.
3. Play the keyboard and enjoy the beautiful voice.

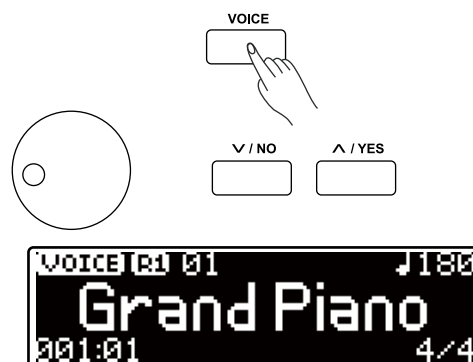

Playing the Styles

The instrument features a variety of styles. Please refer to the Style List.

1. Press the [STYLE] button to enter the style mode. The LCD shows the current style name and number.
2. Use the [Data Dial] or [+ / YES] / [- / NO] button to select a desired style.
3. Press the [START/STOP] button, and then play the keys in the left hand area to start playing the style.

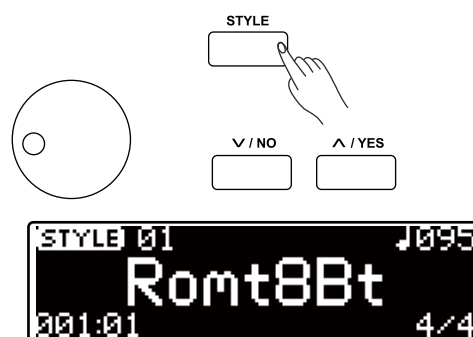

Playing the Songs

The instrument has a variety of preset songs. Please refer to the Song List.

1. Press the [SONG] button to enter the song menu. The LCD shows the current song name and number, the preset tempo and the time signature.
2. Use the [Data Dial] or [+ / YES] / [- / NO] button to select a desired song.
3. Press the [START/STOP] button to start or stop playing the selected song.
4. When the playback stops, press the [STYLE] or [VOICE] button to exit the song menu.

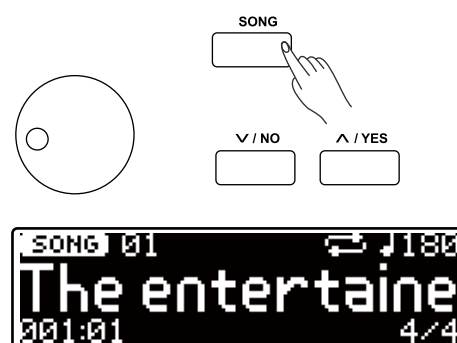

Advanced Use

Playing the Voices

The instrument features a variety of exceptionally realistic voices. Please refer to the Voice List.

Playing a Voice

1. Press the [VOICE] button or one of the VOICE select buttons to enter the voice mode. The LCD shows the current upper voice name and number.
2. Use the [Data Dial] or [+ / YES] / [- / NO] button to select a desired voice. You can also use the VOICE select buttons to select a preset voice.
3. Play the keyboard and enjoy the beautiful voice.

Note:

When the dual and lower functions are turned on, you can press the [VOICE] button repeatedly to shift between the upper, dual or lower voice. The selected one will be highlighted on LCD.

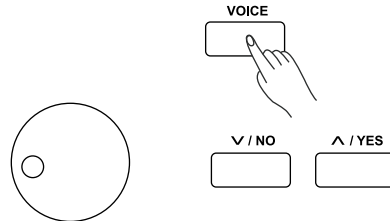
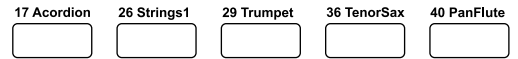
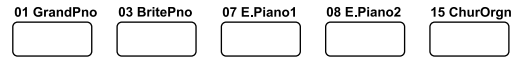

Playing Two Voices Simultaneously - Dual

The dual function allows two different voices to be layered together, creating a much richer sound. Turn the function on, you can select a second voice for the dual voice.

1. Press the [DUAL] button to turn on the dual function. The LCD shows the current dual voice name and number.
2. Use the [Data Dial] or [+ / YES] / [- / NO] button to select the desired dual voice. You can also use the VOICE select buttons to select a preset voice.
3. Play the keyboard, and you will hear two different voices layered together, just like two different instruments playing at the same time.
4. Press again the [DUAL] button to turn off the function.

Note:

When the keyboard is split, only the right hand area will use the dual function.

DUAL

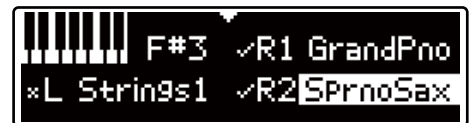

Right 1 Part →

Right 2 Part →



Playing Different Voices with Both Hands - Lower

The lower function splits the keyboard into the left and the right hand areas, each with a different voice. The left hand voice is the lower voice. The split point can be assigned to any key as desired.

1. Press the [LOWER] button to turn on the lower function. The LCD shows the current lower voice name and number.
2. Use the [Data Dial] or [+ / YES] / [- / NO] button to select the desired lower voice. You can also use the VOICE select buttons to select a preset voice.

LOWER

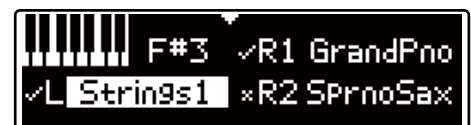
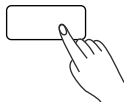

3. Play the keyboard with both hands, and you will hear two different voices from the two areas.
4. Press again the [LOWER] button to turn off the function.

Split point:

The point on the keyboard that separates the lower voice from the upper and dual voices is called "split point". The default split point is at F#3 (34), however you can assign it to any other key.

1. Press and hold the [LOWER] button, then press a key to assign the split point to that key. Alternatively, hold down [LOWER], then use the [Data Dial] or [+YES]/[-NO] button to set the split point.
2. Release the [LOWER] button, it will automatically exit the split point setting.

Playing Voice Demo

All the VOICE select buttons are preset with voice demos. The voice demo allows you to enjoy the beautiful voice of the instrument and helps you find out the most suitable voice for your performance.

1. Press the [VOICE DEMO] button to play the upper voice demo.
2. Press again the [VOICE DEMO] button to stop the demo.

Transpose

The transpose function allows the overall pitch of the instrument to be transposed up or down by maximum of one octave in semitone steps.

1. Press and hold [SHIFT], then press the [Transpose +]/[Transpose-] button to set the transpose value. The LCD shows the current value.
2. Press and hold [SHIFT], then press both the [Transpose +] and [Transpose-] buttons to reset to the default value.

Notes:

1. For example, set the transpose value to -05 or +07, then you can play the G scale using C scale keys.
2. Transpose setting applies to the chord accompaniment and the entire keyboard voice.

Piano Mode

The function will set instantly the voice of the entire keyboard to PIANO at any time.

Press the [PIANO] button to enter the piano mode.

Note:

In piano mode, both the dual and lower functions are not selectable.

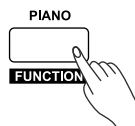
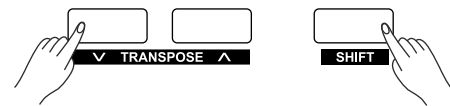
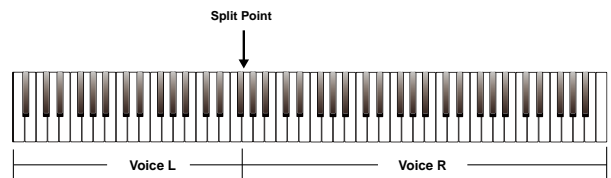

Advanced Use

Twinova

The TWINOVA mode splits the keyboard into two independent areas, both have the same pitch and voice, for the convenience of one-to-one teaching.

1. Press and hold [SHIFT], then press the [TWINOVA] button to turn on the function. The default split point is at F#4.

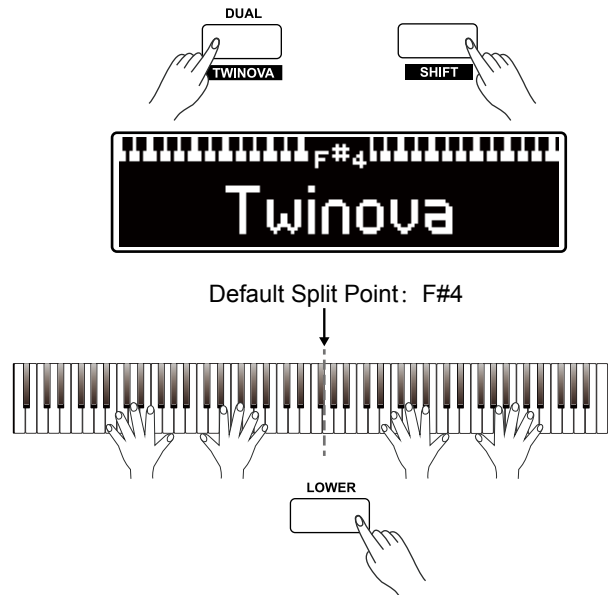

2. Press the [LOWER] button, the split point will be reset to E3.

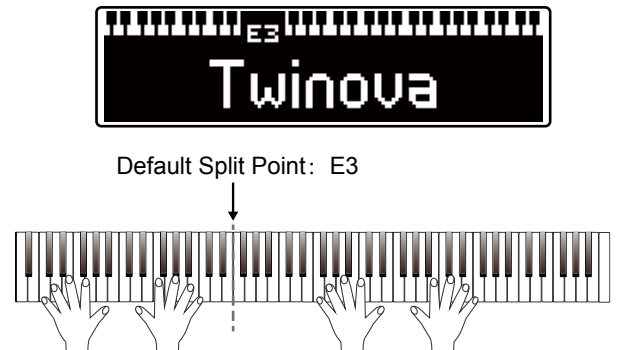

The pedal functions of Twinova:

Left Pedal: notes played on the left hand area will have a longer sustain.

Middle Pedal: notes played on both areas will have a longer sustain.

Right Pedal: notes played on the right hand area will have a longer sustain.

Note:

In Twinova mode, both the dual and lower functions are not selectable.

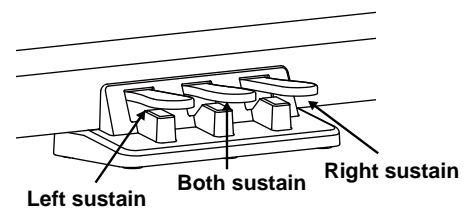

Metronome

The Metronome function provides a steady beat to help you practise at a preset tempo.

1. Press the [METRO] button to turn the metronome on or off.
2. To set the time signature, please refer to the **Beat Type**.

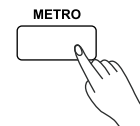

Auto Accompaniment

The instrument features a variety of piano styles. Please refer to the *Style List*.

Selecting a Style

1. Press the [STYLE] button to enter the style mode. The LCD shows the current style name and number.
2. Use the [Data Dial] or [+YES]/[-NO] button to select a desired style.

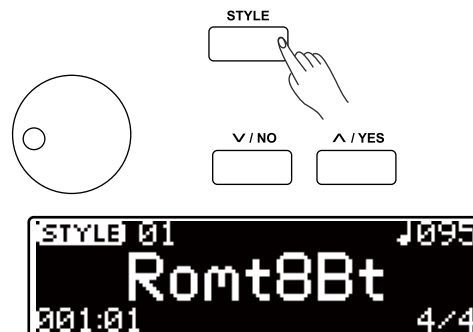

Playing the Style

1. In style mode, press the [START/STOP] button and the button indicator will flash. The auto bass chord is automatically turned on. As soon as you play the keys in the left hand area, the style will start playing.
2. Press again the [START/STOP] button to stop playing the style and turn off the auto bass chord.

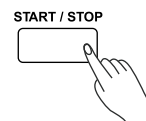

Fill A/B

1. When you start the accompaniment, it plays the default main A pattern.
2. Then press the [FILL A/B] button, it will play a fill-in pattern, and the button indicator will flash. When the fill-in completes, it will shift to the main B pattern, and the button indicator will light off.
3. Again, press the [FILL A/B] button, it will play a fill-in pattern, and the button indicator will flash. When the fill-in completes, it will shift to the main A pattern, and the button indicator will light on.

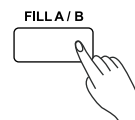

Tempo

Each style, song or metronome on the instrument is preset with a default tempo. However, you can adjust it with the [TEMPO] button, over the range of 30~280.

1. Press the [TEMPO+]/[TEMPO-] button to adjust the current tempo value. When the tempo is flashing on LCD, you can also use the [Data Dial] to make a quick change in the value.
2. Press both [TEMPO+] and [TEMPO-] buttons simultaneously to reset to the default value.

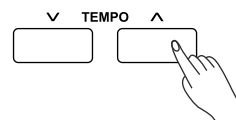

Song

Listening to the Songs

This instrument features many beautiful piano songs. Please refer to the Song List.

1. Press the [SONG] button to enter the song mode. The LCD shows the current song name and number.
2. Use the [Data Dial] or [+ / YES] / [- / NO] button to select a desired song.
3. Press the [START / STOP] button to start or stop playing the song. You can set to loop a song or all songs in the Function Menu.

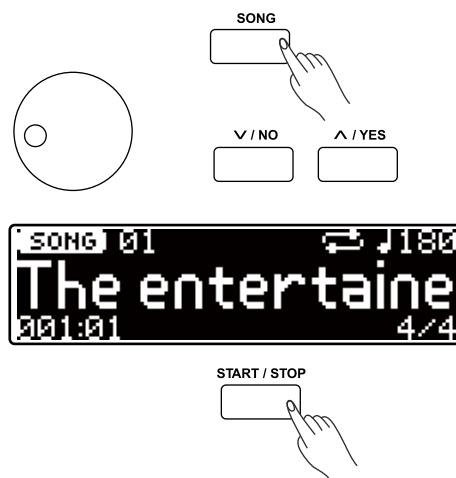

Practise the Songs

All preset songs can be practised with melody-off.

1. Press and hold [SHIFT], then press the [LEFT] button to turn off the left-hand melody. LCD shows "L-OFF". You can practise the left hand part of the song.
2. In the same way, press and hold [SHIFT], then press the [RIGHT] button to turn off the right-hand melody. LCD shows "R-OFF". You can practise the right hand part of the song.

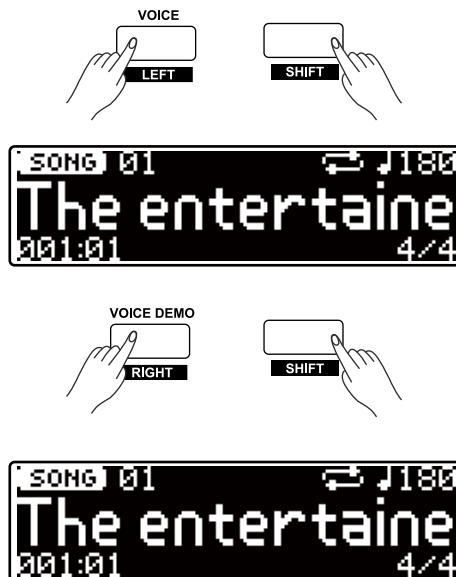

MIDI Recording

The easy-to-use song recording features allows you to record in real-time your keyboard performance, save it as a user song, and then play it back.

Record with Style Accompaniment

1. Press the [RECORD] button to enter the user song menu. LCD shows the current user song name and number. Use the [Data Dial] or [+ / YES] / [- / NO] button to select a user song to which you are recording will be saved. A blank user song is marked with “empty” at the end of its name.
2. The default setting is recording with style accompaniment. However, you can press the [STYLE] / [SONG] button to shift between the two recording modes. Press the [RECORD] button to enter the recording standby mode. “REC-MIDI” will flash on LCD.
3. Now, play the keyboard to start recording. The “REC-MIDI” indicator lights on. All notes you play will be recorded in real-time. Alternatively, press the [START/STOP] button to start recording. And as soon as you play the keys in the left hand area, the style will start playing and the accompaniment will be recorded as well.
4. Press the [RECORD] button to stop and save the recording. The “REC-MIDI” indicator lights off.
5. It enters the song mode when recording is stopped. LCD shows the user song name and number. Press the [START/STOP] button to start playing the user song.

Record with Song Accompaniment

1. Press the [RECORD] button to enter the user song menu. LCD shows the current user song name and number. Use the [Data Dial] or [+ / YES] / [- / NO] button to select a user song to which you are recording will be saved. A blank user song is marked with “empty” at the end of its name.
2. Press the [SONG] button to select recording with song accompaniment. Then press the [RECORD] button to enter the recording standby mode. “REC-MIDI” will flash on LCD.
3. Play the keyboard or press the [START/STOP] button to start recording. The song will start playing and be recorded as well.
4. Press the [RECORD] button to stop and save the recording. The “REC-MIDI” indicator lights off.
5. It will enter the song mode when recording is stopped. LCD shows the user song name and number. Press the [START/STOP] button to start playing the user song

Notes:

1. If the selected user song has data, the original data will be replaced with new data after the recording.
2. If the memory gets full, it will automatically stop and save the recording.

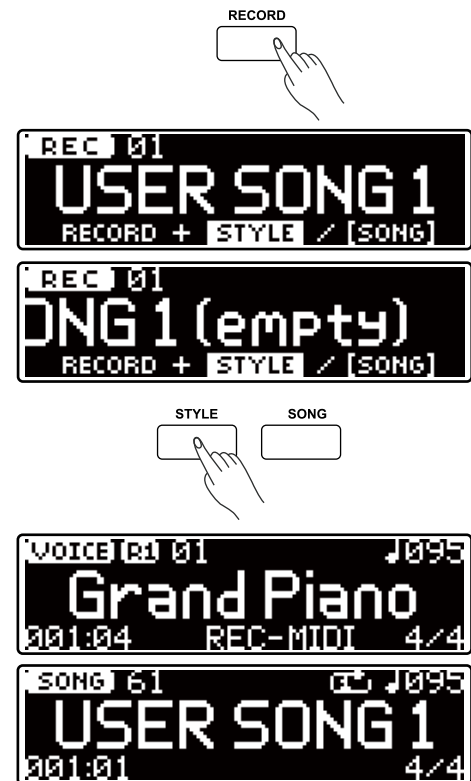

Audio Recording

The audio recording will record your performance and save it to the USB flash drive in the MP3 format. During recording, all sound you hear from the instrument will be recorded.

1. Connect the USB flash drive to the instrument, and then wait until the initialization is finished. The button LED of [USB DEVICE] will light up after the initialization.
2. Press the [AUDIO RECORD] button to start recording. The button LED of [USB DEVICE] will flash and the "REC-MP3" will light on LCD as well.
3. Press the [AUDIO RECORD] button to stop and save the recording to the root directory of the USB flash drive, in the name of "Audioxxx.mp3". The button LED lights off.
4. After saving, it will enter the play menu of the USB flash drive. LCD shows the song name and starts playing the recorded song. Alternatively, you can press the [USB DEVICE] button to enter the play menu, and then select a user song to play back. Please refer to Connecting USB Flash Drive.

Note:

To avoid an error or damaging the USB flash drive, do not remove it or turn off the power when saving is in progress.

USB DEVICE



AUDIO RECORD

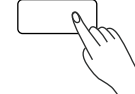

START / STOP

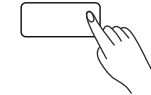

Connecting USB Flash Drive

The piano recognizes USB flash drives, sizing from 128M to 32G in the format of FAT32. We recommend to format the USB flash drive on the piano before using.

Note:

A USB flash drive in the FAT32 format supports up to 512 files under the root directory. Any number larger than this may result in errors when saving or recording to the USB flash drive.

Play

1. Press the [USB DEVICE] to enter the play menu. LCD shows all the MIDI files and MP3 files under the root directory of the USB flash drive.
2. Use the [Data Dial] or [+ / YES] / [- / NO] button to select a desired file.
3. Press the [START / STOP] button to start playing the selected file. You can set to loop a sing song or all songs in the Function Menu.
4. Press again the [START / STOP] button to stop playing.

USB DEVICE

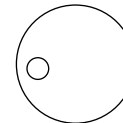
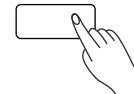

V / NO

^ / YES



Save

1. In the play menu, press again the [USB DEVICE] button to enter the USB menu. Then use the [Data Dial] to select "Save user song".
2. Press [+ / YES] to save all the user data to the root directory of the USB flash drive, in the name of "UserSong00X_YYMMDD_NUB.MIDI".
3. After saving, LCD will show "User song save successful!", then return to the USB menu.

File Name Rules:

UserSong00X: user song name and number (corresponds to the user song on the instrument).

YYMMDD: year/ month/ date.

NUB: the item number when saving to the USB flash drive, over the range of 001~512.

Load

1. In the play menu, press again the [USB DEVICE] button to enter the USB menu. Then use the [Data Dial] to select "Load user song".
2. Press [+ / YES] to enter the Load menu. LCD shows all the MIDI files (*.mid) under the root directory. Use the [Data Dial] to select one.
3. Press [+ / YES] and then use the [Data Dial] to select a user song to which the loading will be saved.
4. Press [+ / YES] and LCD will show "Overwrite the User Song?". Press [+ / YES] to load the song or press [- / NO] to cancel.
5. It will return to the USB menu after loading.

Note:

After loading, it will overwrite the original user songs on the instrument!

Format

1. In the play menu, press again the [USB DEVICE] button to enter the USB menu. Then use the [Data Dial] to select "Format USB".
2. Press [+ / YES], the LCD will show "Format the USB Flash Drive?". Press [+ / YES] to format the flash drive or press [- / NO] to cancel.
3. It will return to the USB menu after formatting.

Notes:

1. Formatting will delete all data on the USB flash drive!
2. It may take some time to format a USB flash drive of large capacity. Please wait patiently.

USB DEVICE

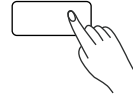

USB DEVICE

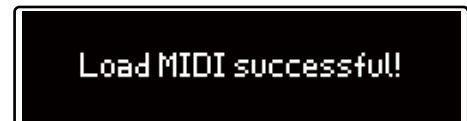
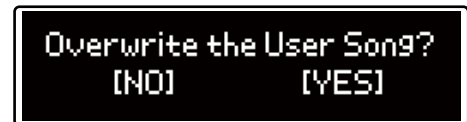
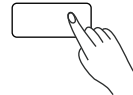

USB DEVICE

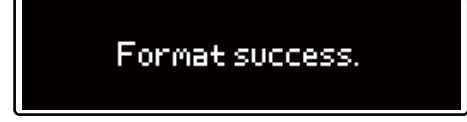
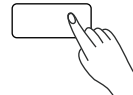

Function Menu

The function menu includes the function features of the instrument. You can select and adjust their parameters as desired.

1. Press and hold [SHIFT], then press the [FUNCTION] button to enter the function menu. LCD shows the current function option.

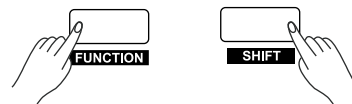

2. Use the [Data Dial] to select a function option, then use the [+ / YES] / [- / NO] button to adjust the parameter.

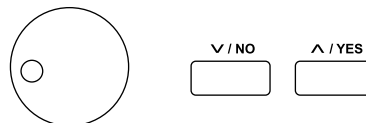

3. Press both [+ / YES] and [- / NO] buttons simultaneously to reset to default.

List of the function options and the value range:

NO.	Option	LCD Display	Range	Default
1	Tune	TUNE	-50 ~ +50	00
2	Voice R1 Octave	OCTAVE R1	-1 ~ +1	0
3	Voice R2 Octave	OCTAVE R2	-1 ~ +1	0
4	Voice L Octave	OCTAVE L	-1 ~ +1	+1
5	Touch	TOUCH	OFF,SOFT2,SOFT1,NORMAL, HARD1, HARD2	NORMAL
6	Voice R1 Volume	VOLUME R1	0~32	24
7	Voice R2 Volume	VOLUME R1	0~32	20
8	Voice L Volume	VOLUME L	0~32	22
9	Style Volume	VOLUME STYLE	0~32	22
10	Song Volume	VOLUME SONG	0~32	23
11	Beat Type	METRONOME	2/2~12/8	4/4
12	Speaker EQ	SPEAKER EQ	Piano, Classical, Jazz, Pop, Rock, R&B	Piano
13	String Resonance	STRING RES.	0~32	19
14	Reverb Type	REVERB TYPE	Room 1, Room 2, Room 3, Hall 1, Hall 2, Hall 3, Hall 4, Church, My Garage, Piano Hall	Hall 3
15	Reverb Level	REVERB LEVEL	0~32	015
16	Chorus Type	CHORUS TYPE	Chorus 1, Chorus 2, Chorus 3, Chorus 4, GM Cho.1, GM Cho.2, Celeste 1, Celeste 2, SymPhonic1, SymPhonic2	Chorus 2
17	Chorus Level	CHORUS LEVEL	0~32	000
18	MIDI OUT Channel	MIDI OUT CH	1~16	1
19	Song Looping	SONG LOOP	Single, All	All
20	Auto Power Off	POWER OFF	Never, 30min, 1 hour	30min
21	System Time-Year	YEAR	2015~2100	2015
22	System Time -Month	MONTH	Jan.~ Dec.	N/A
23	System Time -Date	DAY	1~31	N/A
24	System Time -Hour	HOUR	0~23	N/A
25	System Time -Minute	MINUTE	0~59	N/A
26	Restore Factory Setting	SYSTEM RESET	NO, Execute	N/A

Tune

The function sets the pitch of entire keyboard in a 2-cent increment.

1. In the function menu, use the [Data Dial] to select "TUNE".
2. Use the [+ / YES] / [- / NO] button to adjust the value over the range of ± 50 .

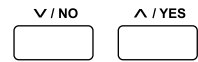
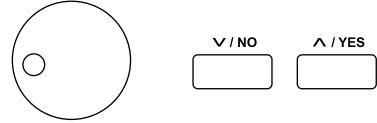

Octave

The octave function will raise or lower the pitch of the entire keyboard by an octave.

1. In the function menu, use the [Data Dial] to select "OCTAVE R1" / "OCTAVE R2" / "OCTAVE L".
2. Use the [+ / YES] / [- / NO] button to adjust the value over the range of ± 1 .

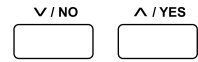
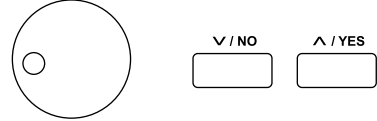

Note:

The octave value of each preset voice may be different.

Touch

The touch response feature will let you dynamically and expressively control the voice volume with your playing strength, just as on an acoustic instrument.

1. In the function menu, use the [Data Dial] to select the "TOUCH".
2. Use the [+ / YES] / [- / NO] button to select a touch level.

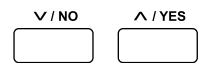
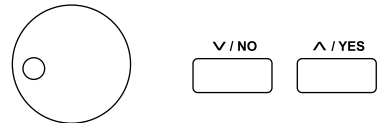

Note:

The touch setting will be saved automatically when you turn off the power.

Volume

You can adjust separately the volume for the Voice R1 / Voice R2 / Voice L / accompaniment / Song, so as to keep an appropriate volume balance.

1. In the function menu, use the [Data Dial] to select "VOLUME R1", "VOLUME R2", "VOLUME L", "VOLUME STYLE" or "VOLUME SONG".
2. Use the [+ / YES] / [- / NO] button to adjust the value over the range of 0~32.

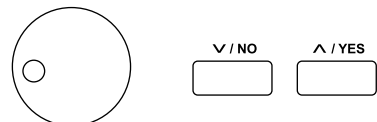

Time Signature

The instrument features 14 types of time signature. Default setting is 4/4.

1. In the function menu, use the [Data Dial] to select "METRONOME".
2. Use the [+ / YES] / [- / NO] button to select a desired time signature.

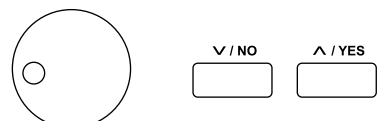

Function Menu

Speaker EQ

The EQ controls the gain of different frequency band. And different gain setting will produce different sound effect. Try playing with a desired EQ setting.

1. In the function menu, use the [Data Dial] to select "SPEAKER EQ".
2. Use the [+ / YES] / [- / NO] button to select a desired type of EQ setting.

Notes:

1. The setting will change the sound from the speakers only, but will not affect the sound from the AUX OUT or PHONES jacks.
2. The EQ setting will be saved automatically when you turn off the power.

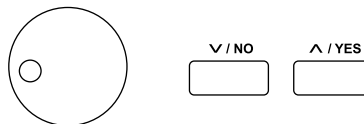

String Resonance

When a piano voice is selected, pressing the sustain pedal will add string resonance effect to the notes you play. The string resonance effect faithfully recreates the resonance from the strings and soundboard of an acoustic grand piano.

1. In the function menu, use the [Data Dial] to select "STRING RES.".
2. Use the [+ / YES] / [- / NO] button to adjust the string resonance level.

Note:

The string resonance setting will be saved automatically when you turn off the power.

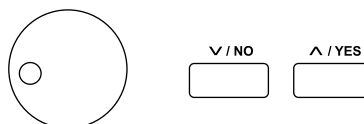

Reverb

The reverb effect makes your performance sound like you are playing in a concert hall, or live in a club.

Reverb Type

1. In the function menu, use the [Data Dial] to select "REVERB TYPE".
2. Use the [+ / YES] / [- / NO] button to select a desired reverb type.

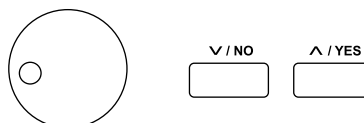

Reverb Level

1. In the function menu, use the [Data Dial] to select "REVERB LEVEL".
2. Use the [+ / YES] / [- / NO] button to adjust the reverb level.

Note:

The reverb settings will be saved automatically when you turn off the power.

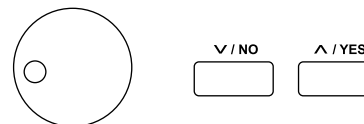

Chorus

The chorus effect makes your playing sound like multiple parts are being played together at the same time.

Chorus Type

1. In the function menu, use the [Data Dial] to select "CHORUS TYPE".
2. Use the [+ / YES] / [- / NO] button to select a desired chorus type.

Chorus Level

1. In the function menu, use the [Data Dial] to select "CHORUS LEVEL".
2. Use the [+ / YES] / [- / NO] button to adjust the chorus level.

Note:

The chorus settings will be saved automatically when you turn off the power.

MIDI OUT Channel

You can set the MIDI OUT channel for Voice R1 as required.

1. In the function menu, use the [Data Dial] to select "MIDI OUT CH".
2. Use the [+ / YES] / [- / NO] button to set the MIDI OUT channel.

Note:

The channel setting will be saved automatically when you turn off the power.

Song Looping

You can play back the songs in two ways: loop all the songs or loop a single song.

1. In the function menu, use the [Data Dial] to select "SONG LOOP".
2. Use the [+ / YES] / [- / NO] button to set the looping pattern.

Note:

The loop setting will be saved automatically when you turn off the power.

Auto Power Off

The instrument will automatically shut down after 30 minutes if it is not used, however, you can change the time setting or turn off the function as desired.

1. In the function menu, use the [Data Dial] to select "POWER OFF".
2. Use the [+ / YES] / [- / NO] button to change the setting.

Note:

the power off setting will be saved automatically when you turn off the power.

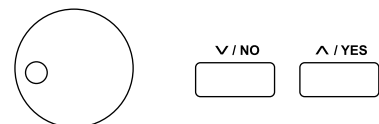
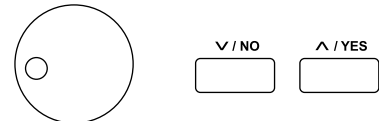
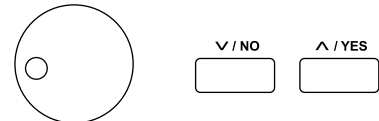
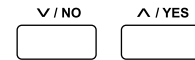
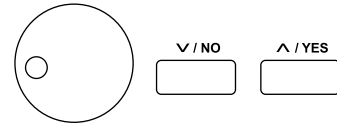

Function Menu

System Time

Please set the correct system time. It may use the system time when saving to the USB flash drive or in other operation.

1. In the function menu, use the [Data Dial] to select "Year"/ "Month"/ "Day"/"Hour"/"Minute".
2. Use the [+ / YES] / [- / NO] button to set the time.

Note:

The time setting will be saved automatically when you turn off the power.

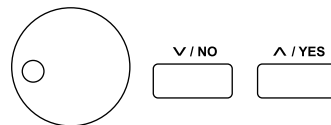

Restore Factory Setting

1. In the function menu, use the [Data Dial] to select "SYSTEM RESET".
2. Press [+ / YES] to select "Execute", LCD will show "Reset all settings?"
3. Press [+ / YES] to reset to the default setting.
Note: the operation will delete all user settings and will not be recovered.
4. LCD continues to show "Delete the user song?", indicating it will delete all user songs.
5. Press [+ / YES] to delete all user songs.
Note: the operation will delete all user songs and will not be recovered.
6. The above operations may take some time to finish. Please wait patiently.

Note:

Do not turn off the power if the resetting operation is in progress, otherwise it may cause an error to the internal setting and consequently lead to a malfunction.

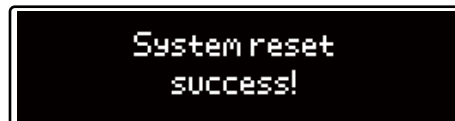
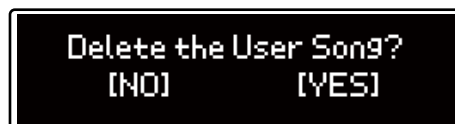
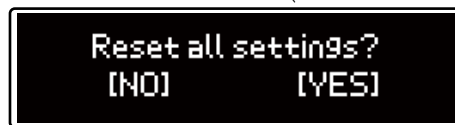
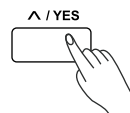
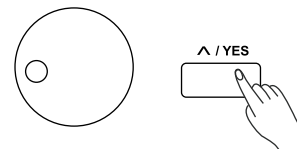

Working with a Computer or a Smart Device

The piano is a powerful instrument with USB digital audio jacks and USB MIDI IN/OUT jacks.

With this exciting new feature, you can use the digital music from a computer or your smart phone as accompaniment, or use your piano as an excellent USB speaker. What's more, you can even use your smart device or laptop to record lossless digital audio of your performance and share with your friends.

Connecting a Computer

1. Use a USB cable to connect the USB TO HOST jack of the instrument to a USB port of a computer.
2. The computer will recognize the piano and install the driver automatically, after which, you will need to set the piano as AUDIO and MIDI IN/OUT device on the computer.
3. You can use the speaker system of the piano to play back music on the computer or record your piano performance in lossless digital signal to the computer with recorder software.
4. With a MIDI sequencer software, you can also use the piano as a MIDI sound source or a MIDI keyboard.

Host Requirements:

Windows XP SP3 or later version.

OSX 10.8 or later version.

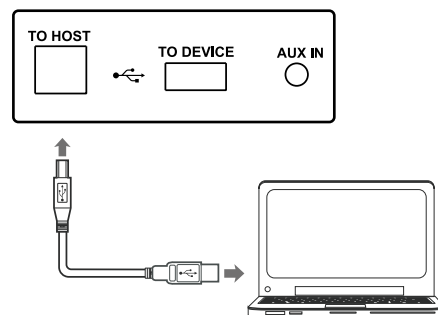

Connecting a Smart Device

1. Use a USB cable to connect the USB TO HOST jack of the instrument to a smart device, such as a smart phone or tablet computer.
2. You can use the speaker system of the piano to play back music on the smart device or record your piano performance in lossless video and audio signals to the smart device.
3. With a MIDI sequencer APP, you can also use the piano as a MIDI sound source or a MIDI keyboard.

Host Requirements:

Android 4.0 or later version. Some Android devices may not have the necessary driver and consequently cannot recognize the piano.

iOS6.0 or later version. Connection with iOS device requires the Apple Camera Connection Kit.

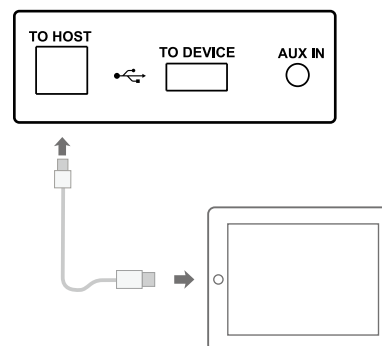

Troubleshooting

Problem	Possible Cause and Solution
The speakers produce a pop sound whenever the power is turned ON or OFF.	This is normal and is no cause for alarm.
No sound when the keyboard is played.	1. Make sure the master volume is set to an appropriate level. 2. Check if headphones are plugged into Jack 3. The R1/R2/L voice volume may be set too low. Set the voice volume to an appropriate level.
When using a mobile phone, noise is produced.	Using a mobile phone in close proximity to the instrument may produce interference. To prevent this, turn off the mobile phone or use it further away from the instrument.
The auto accompaniment does not play after pressing the START button.	You may be trying to start accompaniment by playing a key in the right-hand range of the keyboard. To start the accompaniment with Sync Start, make sure to play a key in the left-hand range of the keyboard.
After connecting with a computer, the instrument cannot be recognized.	Please check if the USB cable is being connected firmly, or try connecting another USB port on the computer, without the need to install another driver on the PC.

Specifications

Display

2.08" Matrix OLED Display

Keyboard

88 Graded Hammer-Action Keys with Triple Sensors

Polyphony

256

Voice

45 Panel Voices,
128 GM Voice,
8 GM Drum kits

Song

60

Style

50

Demo

2 Piano Demos
45 Voice Demos

Control button/ knob

Power switch, Volume, Brilliance, Tempo+/-, Metro, Style, Song, Demo, Start/Stop, Fill A/B, Record, Audio Record, USB Device, Data Dial, +/-Yes, -/No, Transpose+/-, Voice, Voice Demo, Dual, Lower, Piano, Function, Shift, Twinova, Left, Right, Voice Select buttons.

MIDI Record

5 SMF 1 MIDI Songs

Audio Record

44.1KHz 16bit Stereo 320Kbps CBR MPEG-1 layer 3 audio

Connectors

2 PHONES, AUX IN, AUX OUT, MIDI IN/OUT, USB to Host, USB to Device, PEDALS (Soft, Sostenuto, Sustain).

Power Supply

DC 15V/2500mA

Speakers

Woofer: 6 Ω 40W x 2

Tweeter: 4 Ω 25W x 2

Dimensions

1400(L) x 492(W) X 910(H) mm

Weight

59KG

* All specifications and appearances are subject to change without notice.

Voice List

No.	Voice Name
1	Acoustic Grand Piano
2	Acoustic Grand Piano (wide)
3	Bright Acoustic Piano
4	Electric Grand Piano
5	Honky Tonk Piano
6	Harpsichord
7	Electric Piano 1
8	Electric Piano 2
9	Clavi
10	Music Box
11	Vibraphone
12	Drawbar Organ
13	Percussive Organ
14	Rock Organ
15	Church Organ
16	Reed Organ
17	Accordion
18	Tango Accordion
19	Harmonica
20	Nylon Guitar & Acoustic Bass
21	Steel Guitar & Finger Bass
22	Slap Bass & Vibraphone
23	Violin
24	Cello
25	Orchestral Harp
26	String Ensembles 1
27	String Ensembles 2
28	Choir Aahs
29	Trumpet
30	Trombone
31	Tuba
32	French Horn
33	Brass Section
34	Soprano Sax
35	Alto Sax
36	Tenor Sax
37	Baritone Sax
38	Clarinet
39	Flute
40	Pan Flute
41	Sitar
42	Banjo
43	Shamisen
44	Koto
45	Bag Pipe

Style List

No.	Style Name
1	Romantic 8beat
2	Pop 8Beat
3	Slow Rock
4	Lyric 3Beat
5	Pop Waltz
6	Slow Waltz
7	Waltz1
8	Waltz2
9	Waltz3
10	Vienna Waltz
11	1-Mar
12	2-Mar
13	Polka
14	Italian Polka
15	Jazz Pub
16	Jazz 1
17	Jazz 2
18	Jazz 3
19	Jazz 4
20	Jazz 5
21	Boogie
22	Jive
23	Dixland
24	Latin
25	Tango
26	Lambada
27	Samba
28	ChaCha
29	Beguine
30	Salas
31	Pop Bossa
32	Blues1
33	Blues2
34	Blues3
35	Jazz Bluse
36	Piano Beat
37	Piano Bar
38	Pop 1
39	Pop 2
40	Pop 3
41	Pop 4
42	Pop Country
43	Pianist 1
44	Pianist 2
45	Ballad 1
46	Ballad 2
47	Ballad 3
48	Ballad 4
49	6/8 Ballad
50	6/8Ballad 2

Song List

No.	Song Name
1	The entertainer
2	Rialto Ripples (Rag)
3	Neapolitan Song
4	Waltzes
5	Turkish March
6	Schos Doll's Dance No. 2
7	Minuet In D Major
8	Inquietude
9	Italian Polka
10	Moment Musical
11	Prelude In C-Sharp Major
12	The Happy Farmer
13	The Rag-Time Dance
14	Piano Sonata In C Major, K.330. III
15	Mazurka
16	Prelude In E Major
17	Piano Sonata In A Major, K.331. I
18	Waltz For Piano In G-Sharp Minor
19	Gavotte
20	L' Arabesque
21	Austria Variation
22	Schos Doll's Dance No. 7
23	To A Wild Rose
24	Gavotte I
25	Waltz
26	Minuet In G Major (BWV Anh. 116)
27	Innocence
28	Tchaikovsky Waltz
29	Salut d' Amour
30	Barcarolle
31	Robot Doll
32	Consolation
33	2-Part Invention #13 In A Minor.B.W. Iii
34	Minuet In G Major (BWV Anh. 114)
35	Barcarolle
36	Norwegian Dance No.2
37	Moseta Dance
38	The Small Gathering
39	The Return
40	The Wagtail

40	The Wagtail
41	Bulie Dance
42	Tender Blossom
43	Grace
44	Cherish The Memories
45	Chopsticks
46	Four Little Swans
47	Progress
48	Eclogue
49	The Limpid Stream
50	Brave Cavalier
51	The Chatterbox
52	Tarantella
53	Frankness
54	Tender Grieving
55	The Farewell
56	The Chase
57	Habanera
58	Prelude In C Major
59	Fountain
60	Fur Elise

Demo List

No.	Demo Name
1	Fantasia
2	Chpn_op25_no1

MIDI Implementation Chart

Function		Transmitted	Recognized	Remarks
Basic	Default	1ch	ALL	
Channel	Changed	1-16ch	1-16ch	
Mode	Default	x	3	
	Messages	x	3	
	Altered	*****	x	
Note Number	Note	0—127	0—127	
	:True voice	*****	0—127	
Velocity	Note on	o 9nH,V=1-127	o 9nH,V=1-127	
	Note off	x (9nH,V=0)	o(9nH,V=0; 8nH,V=0-127)	
After Touch	key's	x	x	
	Ch's	x	x	
Pitch Bend		x	o	
Control Change	0	o	o	Bank Select
	1	x	o	Modulation
	5	x	o	Portamento Time
	6	o	o	Data Entry
	7	o	o	Volume
	10	x	o	Pan
	11	x	o	Expression
	64	o	o	Sustain Pedal
	65	x	o	Portamento ON/OFF
	66	o	o	Sostenuto Pedal
	67	o	o	Soft Pedal
	80	x	x	Reverb Program
	81	x	x	Chorus Program
	91	o	o	Reverb Level
	93	o	o	Chorus Level
120	x	o	All Sound Off	
121	x	x	Reset All Controllers	
123	o	o	All Notes Off	
Program Change	:true	o *****	o 0—127	
System Exclusive		x	o	
System Common	:SongPosition	x	x	
	:Song Select	x	x	
	:Tune	x	x	
System Real Time	:Clock	o	x	
	:Commands	x	x	
Aux Messages	:LOCAL ON/OFF	x	x	
	:Active sense	o	o	
	:Reset	x	o	
Notes:				

- Mode 1: OMNI ON, POLY
- Mode 2: OMNI ON, MONO

- Mode 3: OMNI OFF, POLY
- Mode 4: OMNI OFF, MONO

- o: YES
- x: NO

