

Heavy duty active 18" powered subwoofer combined with 12" coaxial, high efficiency passive element featuring SAT® technology by K-array™.

The GP1812A active system can drive a GP1812 passive system in a stereo configuration. GP1812A features Powersoft™ DSP and power module with Ethernet remote control through the Armonia™ control software.

Unpacking

Each KGEAR device is inspected before leaving the factory. Upon arrival, carefully inspect the shipping carton, then examine and test your new device. If you find any damage, immediately notify the shipping company. Check that the following parts are supplied with the product:

KGEAR GP1812A

- 1x GH12 12" array element speaker
- 1x GSX18A active subwoofer
- 1x G-POLE standing pole
- 1x 2m (6.5ft) speaker cable
- 1x Power cord

KGEAR GP1812

- 1x GH12 12" array element speaker
- 1x GS18 passive subwoofer
- 1x G-POLE standing pole
- 1x 2m (6.5ft) speaker cable
- 1x 15m (49ft) speaker cable

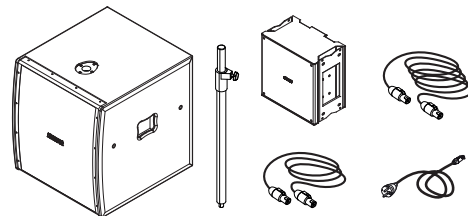

Thank you for choosing KGEAR!

To ensure proper operation, please carefully read this owner's manual and safety instruction before using the product.

After reading this manual, be sure to keep it for future reference.

Should you have any questions about your new device please contact K-array customer service at info@kgear.it or contact the local distributor in your country.

KGEAR by K-array surl
via P. Romagnoli 17 - 50038 - Scarperia e San Piero -
Firenze - Italy - www.kgear.it

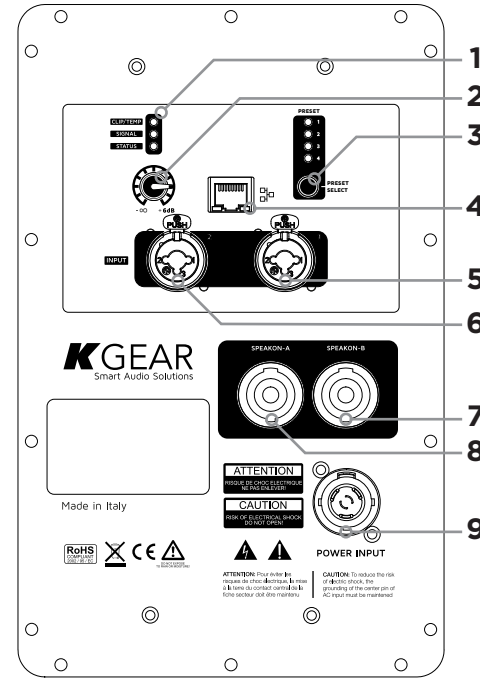

Rear Panel

GP1812A

1. Status LEDs
2. Volume potentiometer
3. DSP preset selection button
4. RJ45 Ethernet port
5. XLR Combo balanced input channel 1
6. XLR Combo balanced input channel 2
7. NL4 SpeakON B speaker output 3 and 4
8. NL4 SpeakON A speaker output 1 and 2
9. powerCON TRUE AC MAIN inlet

GP1812

- A. NL4 SpeakON A: signal in/out
- B. NL4 SpeakON B: signal in/out

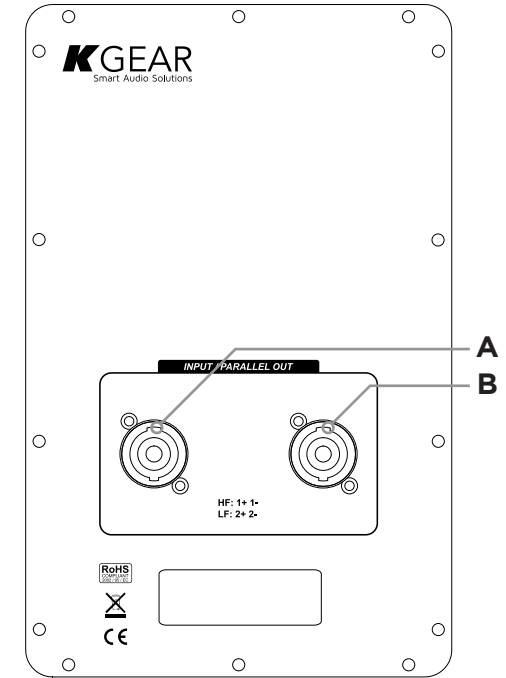

AC MAINS Supply

GP1812A

The GP1812A features a powered subwoofer: the AC Main connection is made via the provided power cord with powerCON TRUE flying connector.

Insert the powerCon TRUE flying connector into the inlet and then rotate it clockwise: once properly plugged, the amplifier will power up.

ArmoniaPlus

ArmoniaPlus is the software for fine tuning and monitoring the KGEAR GP1812A loudspeaker system.

Download ArmoniaPlus from Powersoft website: www.powersoft.com

IMPORTANT SAFETY INSTRUCTIONS

CAUTION
RISK OF ELECTRIC SHOCK
DO NOT OPEN

ATTENTION: RISQUE DE CHOC ELECTRIQUE NE PAS OUVRIR

CAUTION: TO REDUCE THE RISK OF ELECTRIC SHOCK, DO NOT REMOVE COVER (OR BACK). NO USER-SERVICEABLE PARTS INSIDE. REFER SERVICING TO QUALIFIED SERVICE PERSONNEL.



This symbol alerts the user to the presence of recommendations about the product's use and maintenance.



The lightning flash with arrowhead symbol within an equilateral triangle is intended to alert the user to the presence of uninsulated, dangerous voltage within the product enclosure that may be of magnitude to constitute a risk of electrical shock.



The exclamation point within an equilateral triangle is intended to alert the user to the presence of important operating and maintenance (servicing) instructions in this guide.



Operator's manual; operating instructions
This symbol identifies the operator's manual that relates to the operating instructions and indicates that the operating instructions should be considered when operating the device or control close to where the symbol is placed.



For indoor use only
This electrical equipment is designed primarily for indoor use.



WEEE
Please dispose of this product at the end of its operational lifetime by bringing it to your local collection point or recycling center for such equipment.



This device complies with Restriction of Hazardous Substances Directive.



Warning. Failure to follow these safety instructions could result in fire, shock or other injury or damage to the device or other property.

General heed and warnings

- Read these instructions.
- Keep these instructions.
- Heed all warnings.
- Follow all instructions.
- Do not use this apparatus near water.
- Clean only with dry cloth.
- Do not block any ventilation openings. Install in accordance with the manufacturer's instructions.
- Do not install near any heat sources such as radiators, heat registers, stoves, or other apparatus (including amplifiers) that produce heat
- Do not defeat the safety purpose of the polarized or grounding plug. A polarized plug has two blades with one wider than the other. A grounding plug has two blades and a third grounding prong. The wide blade or the third prong is provided for your safety. If the provided plug does not fit into your outlet, consult an electrician for replacement of the obsolete outlet.
- Only use attachments/accessories specified by the manufacturer.
- Protect the power cord from being walked on or pinched particularly at the plugs, convenience receptacles, and at the point where they exit from the apparatus.
- Clean the product only with a soft and dry fabric. Never use liquid cleaning products, as this may damage the products cosmetic surfaces.
- Use only with the cart, stand, tripod, bracket, or table specified by the manufacturer, or sold with the apparatus. When a cart is used, use caution when moving the cart/apparatus combination to avoid injury from tip-over.
- Unplug this apparatus during lightning storms or when unused for long periods of time.
- Avoid placing the product in a location under direct sunlight or near any appliance that generates UV (Ultra Violet) light, as this may change the product surface finishing and cause a change in color.
- Refer all servicing to qualified service personnel. Servicing is required when the apparatus has been damaged in any way, such as power-supply cord or plug is damaged, liquid has been spilled or objects have fallen into the apparatus, the apparatus has been exposed to rain or moisture, does not operate normally, or has been dropped.



These apparatus are intended for professional use.

Installation and commissioning may only be carried out by qualified and authorized personnel.

- **CAUTION:** These servicing instructions are for use by qualified service personnel only. To reduce the risk of electric shock, do not perform any servicing other than that contained in the operating instructions unless you are qualified to do so.
- **WARNING:** Only use attachments/accessories specified or provided by the manufacturer (such as the exclusive supply adapter, battery, etc.)
- Before turning the power on or off for all devices, set all volume levels to minimum.
- Use only speaker cables for connecting speakers to the speaker terminals. Be sure to observe the amplifier's rated load impedance particularly when connecting speakers in parallel. Connecting an impedance load outside the amplifier's rated range can damage the apparatus.
- KGEAR cannot be held responsible for damage caused by improper use of the loudspeakers.
- KGEAR will not shoulder any responsibilities for products modified without prior authorization.

Service

To obtain service:

1. Please have the serial number(s) of the unit(s) available for reference.
2. Contact the official KGEAR distributor in your country: or KGEAR headquarter at info@kgear.it. Please describe the problem clearly and completely to the Customer Service.
3. You will be contacted back for on-line servicing.
4. If the problem cannot be resolved over the phone, you may be required to send the unit in for service. In this instance, you will be provided with an RA (Return Authorization) number which should be included on all shipping documents and correspondence regarding the repair. Shipping charges are the responsibility of the purchaser.

Any attempt to modify or replace components of the device will invalidate your warranty. Service must be performed by an authorized K-array service center.

Assembling instructions

Tightly screw the G-POLE on top of the subwoofer, then set the GH12 12" array element on top of the G-POLE.

Set the height of the pole according to the height of the listening area.

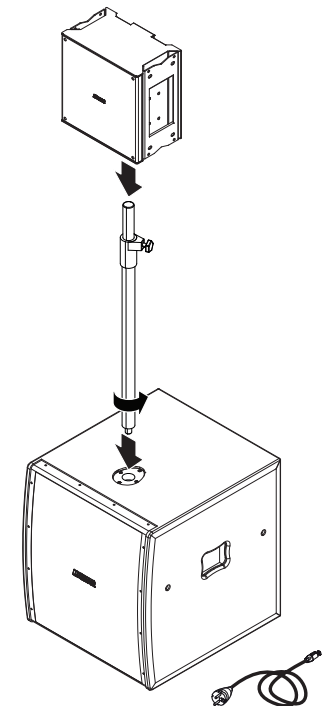

GP1812A wiring

Once assembled, use the 2m (6.5ft) long speaker cable to connect one speakON connector on the GH12 rear panel to the speakON A connector on the active subwoofer rear panel.

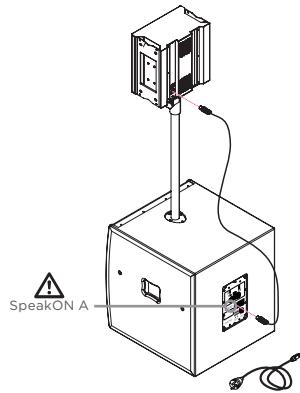

GP1812 wiring

The GP1812 must be bi-amplified feeding the speakON B (on the subwoofer rear panel) with two signals: one for driving the GH12 array element on terminals 1+ 1-, the other one for driving the GS18 subwoofer on the speakON B terminals 2+ 2-.

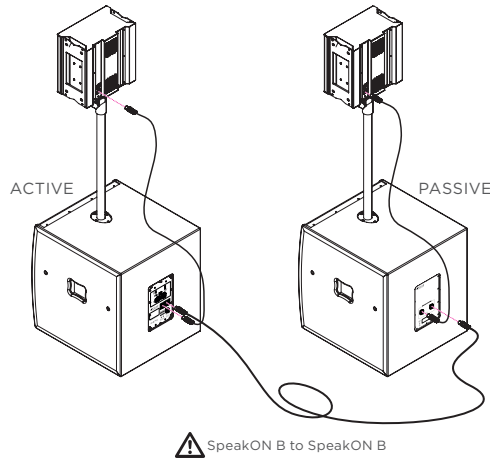

By default, the input signal shall be fed with a pair of cables connected to the XLR Combo balanced input channels 1 and 2 on the GP18A active loudspeaker rear panel.

If only one cable is used to feed the input channels 1 or 2, the double mono configuration can be set with ArmoniaPlus.

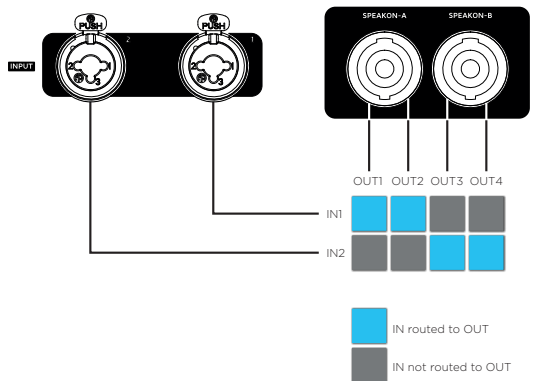

The GP1812A active system implements a 4-channel amp module with DSP: a single GP1812A can drive a GP1812 passive systems in stereo mode.

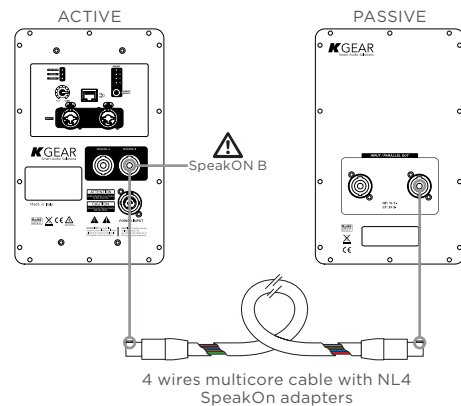

Once assembled, use the the 2m (6.5ft) long speaker cable to connect one speakON connector on the GH12 rear panel to the speakON A connector on the active subwoofer rear panel.

Use the the 15m (49ft) long speaker cable to connect one SpeakON B connector on the subwoofer rear panel to the driving unit (i.e. a GP1812A active system).

SpeakON A and speakON B are connected in parallel in order to make the signal pass through (see picture below).

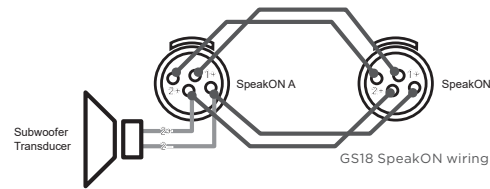

In order to let the signal driving the passive systems, 4 wires multicore cables with NL4 SpeakOn adapters shall be used.

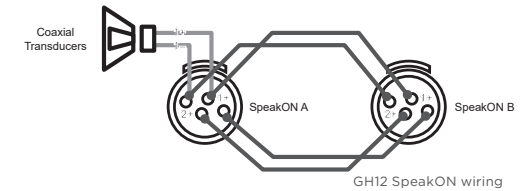
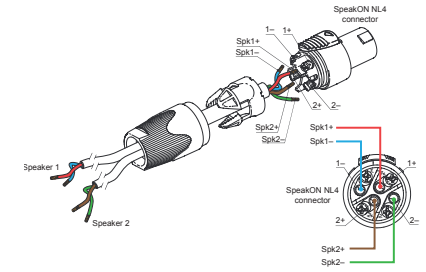

Stereo quad system

Assemble one GP181A active loudspeaker system with three GP1812 passive loudspeaker systems in stereo mode.

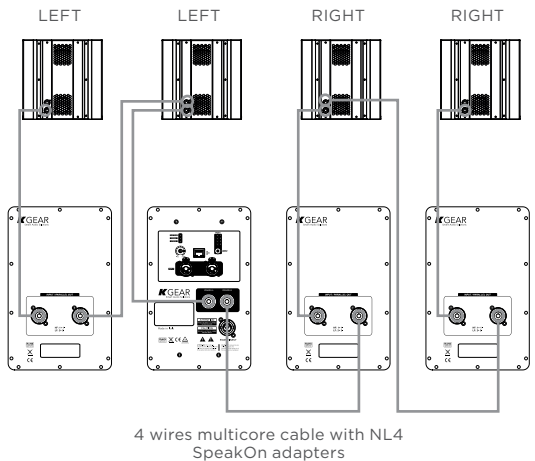

SpeakON A and speakON B of both the GS18 passive subwoofer and the GH12 coaxial array element are connected in parallel in order to make the signal pass through.

Cleaning

Use only a soft, dry cloth to clean the housing. Do not use any solvents, chemicals, or cleaning solutions containing alcohol, ammonia, or abrasives. Do not use any sprays near the product or allow liquids to spill into any openings.

Remote Control With ArmoníaPlus

The built-in DSP can be remote controlled and tuned with the ArmoníaPlus software over an Ethernet network.



1. Download ArmoníaPlus from Powersoft website and install it on your PC.
2. Launch ArmoníaPlus.
3. Log-in with your ArmoníaPlus account.
4. The first time you launch ArmoníaPlus you need to download the KGEAR amplifiers presets form the ArmoníaPlus marketplace.

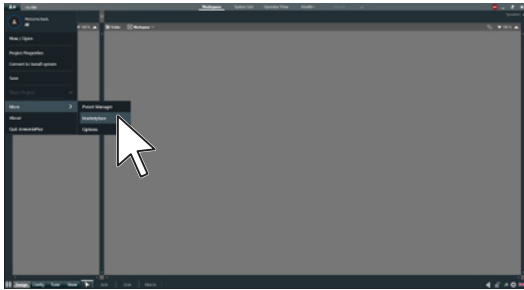

5. Insert «KGEAR» in the search field and add the support to the KGEAR devices you need.

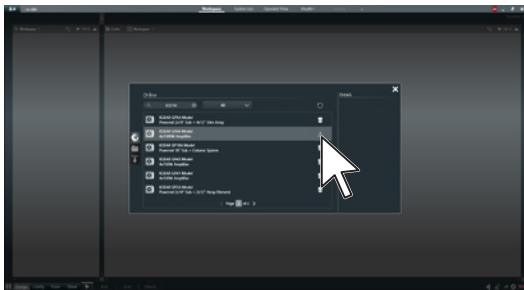

6. Connect the PC with ArmoníaPlus and your KGEAR device to the same local network.

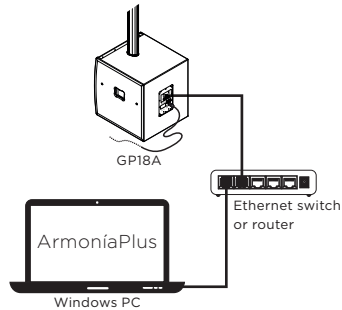

7. Click on the Match button in the bottom toolbar.

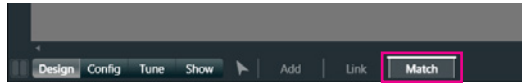

8. Check that the wired network interface is active and that the Synchronization mode is ON.

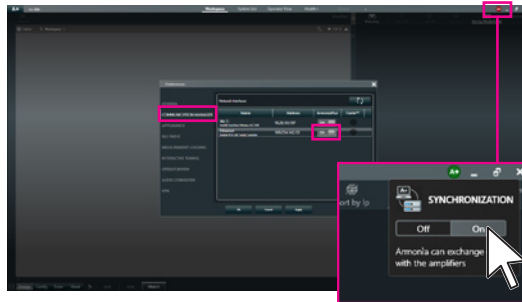

9. Click on the Discovery button.
10. Wait until ArmoníaPlus shows the device, then drag-and-drop the device from the right panel to the Workspace (left panel): the system takes few seconds to synchronize.
11. In order to access the device properties, select the pointer in the bottom toolbar and then double-click on the device in the Workspace.

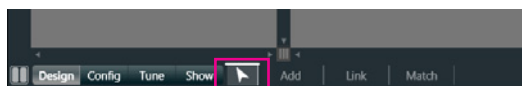

12. You can eventually work off-line in «Design» mode: click on the Add button in the bottom toolbar.

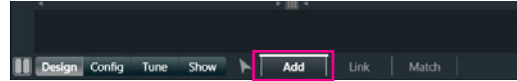

13. In the top menu bar, click on the button labeled «Powered Speaker».

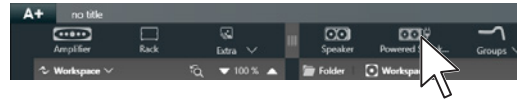

14. In the new window select the Brand / Family / Model / Application according to your needs, the click on Add.

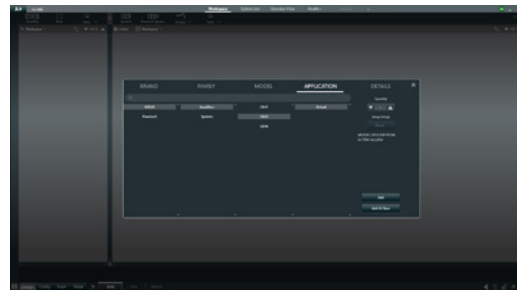

15. The device(s) will be added to the Workspace.

Setting Device Preset

The rear panel features four preset buttons that can be assigned to custom device preset.

A device preset includes the entire configuration of the four output channels and input equalization.

In order to customize the current device preset:

- A. connect the device to ArmoníaPlus;
- B. make your settings;

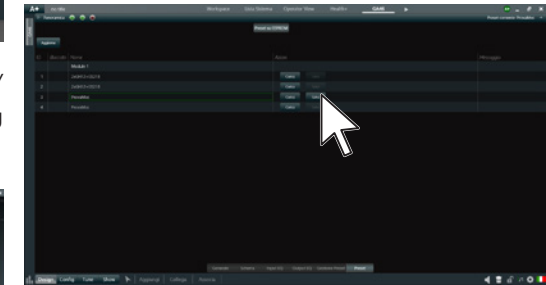

- C. go to the preset windows and click on the Save button: the current device configuration will override the previous settings.

#	Preset Name
1	KGEAR optimized
2	Linear response
3	Subwoofer boost
4	Mid-high boost
Default	KGEAR optimized

The factory presets are listed below.

GP1812A / GP1812

Mechanical Drawings

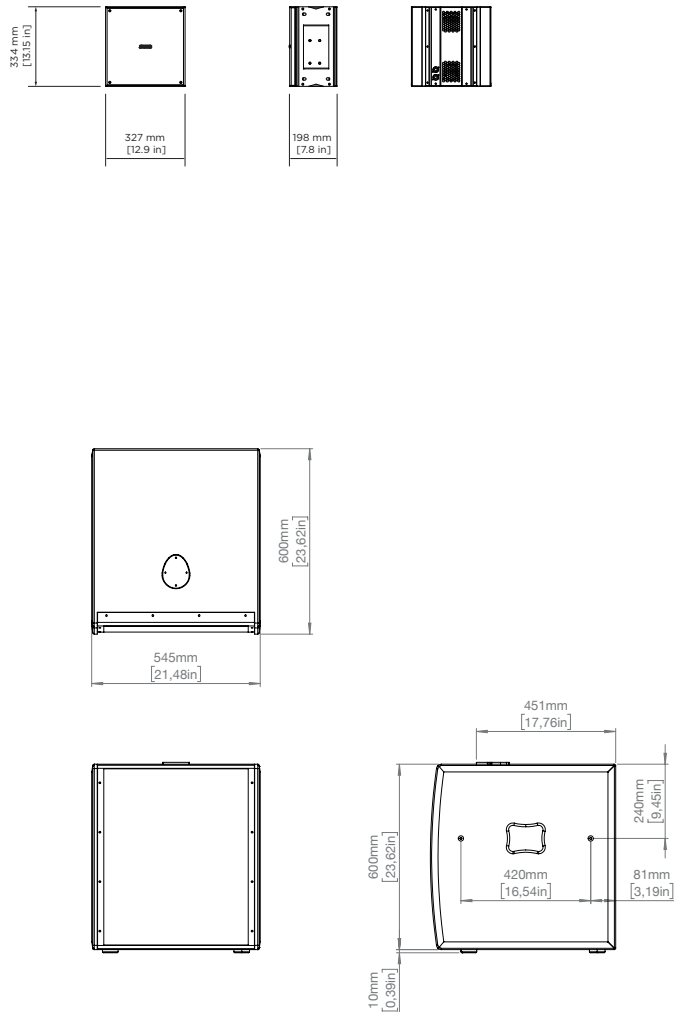

Technical Specifications

GP1812A

Technical specifications
Type Powered Sub + Satellite system
Transducers SUB: 18" woofer TOP: 12" coaxial woofer and 1" compression driver
Frequency Response 30 Hz – 20 kHz (-6 dB)
Max SPL ¹ 129 dB (peak)
Coverage V. 30° H. 90°
Amp Module 4-channel Class-D
Output Power 4x 1500 W @ 4 Ω
Operating Voltage 90-240V AC, 50-60 Hz
Power Consumption 500W Rated Load, (1/8 Max Output Power)
DSP Features Remote control and tuning Input and Output Delay Parametric input EQ Output parametric filters
Connectors RJ45 for remote control 2x Combo XLR Input 2x SpeakON Output 1x PowerCon True AC MAINS
Controls Volume potentiometer Preset selector Remote control through Powersoft ArmoniaPlus Software
Dimensions (WxLxH) 545 x 600 x 1690 mm (21.48 x 23.62 x 66,54 in)
Weight 52 kg (114,64 lb)

¹ Maximum SPL is calculated using a signal with crest factor 4 (12dB) measured at 1 m.

GP1812

Technical specifications
Type Passive Sub + Satellite system
Transducers SUB: 18" woofer TOP: 12" coaxial woofer and 1" compression driver
Frequency Response 30 Hz – 20 kHz (-6 dB)
Max SPL ¹ 129 dB (peak)
Coverage V. 30° H. 90°
Power Handling SUB: 700W TOP: 200W
Nominal Impedance SUB: 8Ω TOP: 32 Ω
Connectors 2x NL4 SpeakON (TOP: 1+, 1- SUB 2+, 2-)
Dimensions (WxLxH) 545 x 600 x 1690 mm (21.48 x 23.62 x 66,54 in)
Weight 48,6 kg (107.1 lb)

¹ Maximum SPL is calculated using a signal with crest factor 4 (12dB) measured at 1 m.