

AK500N

Astell&Kern

---

INSTRUCTION BOOK

User Guide

# CONTENTS

## 01

### Before Use

- 02 Safety precautions
- 07 Remark
- 08 Product Overview
- 11 Product specification
- 12 Package contents
- 13 Name of each part
- 16 Managing power
- 17 Connections
- 27 Upgrading the firmware

## 02

### Using the Device

- 28 Basic operation
- 30 Notification bar
- 32 Music list screen
- 34 Music playback screen
- 35 Listening to music
- 36 Ripping the CD
- 38 Managing the current playlist
- 39 Managing the playlist
- 42 Searching files

- 42 Managing Files
- 45 MQS streaming
- 47 Purchasing music in the store
- 48 Using USB DAC function
- 51 Using bluetooth
- 52 Settings
- 56 Connecting to the network
- 57 Setting the equalizer

## 03

### Miscellaneous

- 59 Trouble shooting
- 60 Copyright
- 60 Certifications
- 63 Gracenote
- 63 Trademarks
- 63 Disclaimers



# SAFETY PRECAUTIONS

Please check [Safety Instructions] before using the device for a safety use.

## Descriptions :

Instructions are divided into “Warning” and “Caution”, and the meanings are explained in the following.





 **Warning** indicates a serious danger.  **Caution** indicates a hazard.

## Explanations of Symbols

 Indicates “Forbidden” or “Prohibited matters”.  Indicates “Required Action” or “Perform as instructed”.

## Use

### **Warning**

-  Users should not decompose, repair or change the product randomly.
  - iriver does not take responsibility for any problems caused by a random decomposition, change or repair.
-  Do not place the metal (coins, hairpins, etc.) or inflammable foreign object inside the product.
-  When lightning do not touch the power cord.
  - You can cause fire or electric shock.
-  Stop using the product immediately, if the operation is not smooth or a failure occurs.
-  If water or foreign object get inside the product, disconnect the power plug from the outlet immediately, quickly wipe with a dry cloth, and get the AS through the near iriver zone.
  - Repair for the damage due to inundation may cost, or even not possible, regardless of the quality assurance period.





- ❗ Pay attention not to apply force or press on the part of the cable is connected, if the cable is connected to the connection port.
  - You can break the sound terminal products.
- ❗ Do not disconnect the USB cable during data transfer.
- ❗ Use a USB port at the rear of the PC USB cable connection.
  - Connection to the USB port with assembly defect or malfunction may develop product failure.
- ❗ Do not use products such as chemicals or cleaning agents, because they spoil the surface and strip lacquer.
- ❗ If you attach a bad LCD protective film or stickers to the screen, the darkening screen phenomenon can occur.
- ❗ If you keep the same screen, an afterimage may remain on the screen.
- ❗ When you touch the screen, use a clean and dry hand.
- ❗ When you touch the screen, do not press with too strong pressure.

 **Caution**





- ⊘ Do not put your hands on the CD inserting slot.
- ⊘ Do not use a non-circular disc.
- ⊘ Do not use a disc with serious scratches or foreign substances.
  - This may cause a malfunction.
- ⊘ Do not stand on the product.
- ⊘ Do not place heavy objects on the product.
- ⊘ Never connect any other type of cable to the terminal except an appropriate cable.
- ❗ You can lose your hearing if you plug earphones or headphones in your ears and hear a large volume.

## POWER CODE AND PLUG

### **Warning**

-  Do not plug or unplug with wet hands.
-  Plug the power plug into a 110~220V(50~60Hz) AC outlet.
-  If there is dust on the power plug pins or mounting surface, please remove the power plug, and then remove the dust.
-  When handling the power cord, please observe the following:
  - Do not compromise. / Do not transform.(ex: extension) / Do not apply heat. / Do not place heavy objects.
  - Do not insert it in a small space. / Do not bend forcibly. / Do not twist. /Do not tie several codes together.
  - You can cause a fire or electric shock.

### **Caution**

-  Do not use a power code except the one comes with the product.
-  Do not use the power code that came with the product to other products.
  - You can cause a fire or electric shock.
-  Please use a grounded plug as a power plug.
-  When removing the power plug from the outlet, hold the power plug strongly.
-  When you do not use the product for long periods of time, unplug the power plug from the outlet.
  - You can cause a fire or electric shock.

## INSTALLATION

### **Warning**

- ⊘ To reduce the risk of fire or electric shock, do not expose the product to rain or moisture.  
Do not let the product contact with water, and do not place objects with liquids, such as vases, on the product.
- ⊘ Do not place or use the product on following. You can cause a fire or electric shock.
  - A place where you can splash water or a dump place such as a bathroom. / A place where rain or fog can flow directly./ Outside of the rainy season. A place with a high temperature like near fire or a heater/
  - A place where is exposed to direct sunlight/ A place where are dust, oil, or smoky (ex. Kitchen)/
  - A place where temperature (-5°C~40°C) is too high or low, or where there is a sudden temperature changes/
  - A place with a strong vibration/ A unstable place such as a wobble table a slanted surface/
  - A place where are strong magnetic objects such as magnets, TV, monitor, speakers, etc. /
  - A place with a corrosive gas (ex. Sulfite, hydrogen sulfide, chlorine ammonia)

 Please move away the product from the TV, if TV changes its color near the product, or if it makes a noise.

### **USB Device**

- You cannot connect a computer to the USB memory port on the product.
- If a USB has a large capacity, it may take several minutes or more to navigate to the file.

- If static electricity is generated when connecting a USB device, a playback can run abnormally.  
In this case, disconnect the USB device and then re-connect.
- A copyrighted track (WMA-DRM\* tracks) cannot be played on this product.
  - \* DRM (Digital Rights Management): several technical methods that are used to control or limit the use of digital media contents.
- Coded or encrypted tracks in a special way cannot be played on this product.
- Do not disconnect the device when playing a file on the USB device.  
Both the product and the USB device can cause a malfunction.
- If you connect by using a USB hub or extension cable, it maybe not recognized by this product.
- Devices that need to install a separate drive are not supported.
- Some USB devices may not be recognized or function correctly.
- iriver does not take responsibility for any loss of data on the USB device that occurs when using this product.

## Remark

### Cleaning the Device

To ensure the best performance from this device, you must keep discs and equipment clean.

- Disconnect the power cord before cleaning.
- Wipe the stain with a soft cloth. If there are a lot of stains on the device, wipe clean with a dry cloth, after wiping with a damp cloth in water.
- The performance of the device can be degraded, damaged, or the paint may peel off, therefore please note the following:  
Do not wipe with a hard cloth. / Do not wipe too hard. / Do not wipe with thinner or benzene. /  
Do not leave for a long time in contact with rubber or plastic/ Do not spray volatile material such as insecticide.

### Disc Handling

- Do not touch or scratch the recorded reflective surface.
- Do not apply foreign substances or write on the label. Do not bend the disc.
- When you clean the disc, use a soft cloth in a straight line from the center towards the edge.  
Do not use thinner, benzene, record cleaner or antistatic sprays.



## Product Overview

The AK500N is the first stationary network audio product from Astell&Kern that truly combines advanced digital technology with analog sound.

### Perfect Extractor

How are you enjoying your precious CD collection?

Are you still listening to your music one CD at a time?

Import your CD collection into the AK500N with the one click.

By taking the acclaimed cdparanoia's CD ripper, in its highly-optimized ripping engine, the AK500N provides users with flawless CD rips through enhanced jitter and error correction support.

The highest sound quality is captured with enhanced jitter correction and excellent CD track error detection and correction.

Two speeds (Normal / Fast) are available for CD-ripping, and the tracks can be saved in either WAV or FLAC.

In addition, Album art and music data are automatically imported from Gracenote's latest music DB.

Gracenote is the most well-recognized and accurate source of music DB in the world.

Also, touch the keypad to enter the CD title, artist, genre, year of release information yourself.

### Pure Sound

A common factor in devices operating in AC power is that the AC power supply is a point of entry for unwanted external noise and exit for device noise. These are the main causes of sound quality degradation.

The AK500N does not allow even 1% of external noise.

Although the AK500N is stationary audio device, it was designed to use a built-in battery for noise isolation. The AK500N physically blocks noise generated in the AC power supply to prevent sound degradation at all levels. Music playback on the AK500N is achieved with battery-only operation, creating a truly Pure Sound.

### **PCM to DSD**

The AK500N features a dedicated DSD chipset for DSD playback and converts PCM file to DSD64 data through audio engine of Astell&Kern.

The AK500N converts high-resolution 32 bit/384 kHz WAV PCM and 24 bit/352 kHz FLAC PCM file to DSD64 data without any down-sampling.

Surely, real time PCM file to DSD64 data playback available.

Go one step further to original sound with this feature by converting, without any distortion, the unique audio information contained within the sound source.

### **Advanced Network**

The network capability of the AK500N is another attractive feature that can't be missed.

The AK500N connects to PCs as well as NAS servers through its DLNA implementation using LAN, Wi-Fi and is easily controlled with an app on smartphones and tablets.

Music on your PC or NAS can be freely streamed and played back without the hassle of having to turn on your PC and connecting a cable and it can output the sound in conjunction with the network speaker.

The AK500N can be easily kept up-to-date with OTA (Over-the-Air) firmware updates.



## **Four BAY SSD**

The AK500N features multi-level cell (MLC) SSD rather than a triple-level cell (TLC) SSD for increased durability and reliability.

The vibration noise generated by conventional HDDs has been eliminated completely.

Save and load large amounts of data even faster than traditional HDDs through the superior speed and stability of SSDs.

1TB/2TB/4TB SSD options are offered to satisfy each user's needs.

By implementing RAID 0 and 5 capabilities optimized for each drive capacity, user data is protected and storage space is efficiently utilized.

Physically independent drives can be combined into a single drive through RAID 0, and one drive in a RAID 5 configuration is used for data parity, ensuring user data safety.

## **Powerful Connections**

The AK500N supports a wide range of inputs and outputs.

Connect various high-end products through the AK500N's digital inputs and outputs (AES/EBU, Coaxial, Optical, BNC). In addition, the analog output supports both Fixed and Variable signals for a direct connection to a powered amplifier. A simple but high-level premium system configuration is possible through the AK500N's flexible digital and analog connections.

For user convenience, the inputs and outputs are expressed in easy-to-read graphics on the touch-screen menu.

# Product specifica- tion

<b>Display</b>	7" WVGA(1280x800) Touch Display
<b>DAC</b>	Cirrus Logic CS4398 x2 (Dual DAC)
<b>Storage</b>	SSD 1TB/2TB/4TB(RAID 0,5)
<b>Digital _Out _Input</b>	AES/EBUx1, BNCx1, Coaxialx1, Opticalx1 AES/EBUx1, BNCx1, Coaxialx1, Opticalx1
<b>Analog _Fixed &amp; Variable Out</b>	Balanced (L/R) x2, RCA (L/R) x2
<b>Fixed output level</b>	3V(RCA, Balanced)
<b>Variable output level</b>	7.5V(RCA) / 10V(Balanced)
<b>Channel Separation</b>	>135dB / 1kHz
<b>Frequency Response</b>	± 0.02dB / 20Hz ~ 20kHz, ± 0.4dB / 10Hz ~ 70kHz
<b>THD(Total Harmonic Distortion)+N</b>	< 0.0008% / 1kHz / 10v, <0.001% / 10Hz ~ 20kHz / 10v
<b>SNR(Signal to Noise Ratio)</b>	118dB / 1kHz / 10v
<b>Audio File Supported</b>	WAV, FLAC, WMA, MP3, OGG, APE, AAC, ALAC, AIFF, DFF, DSF
<b>Audio Sample Rate</b>	8kHz ~ 384kHz (8/16/24bits per sample) DSD Native : DSD64(1bit/2.8MHz) / DSD128(1bit/5.6MHz)
<b>USB Supported</b>	Type A(Host) x2, Type B(Device) x1
<b>USB DAC Supported</b>	UAC(USB Audio Class) 2.0 / DSD64, DSD128, PCM
<b>Network Supported</b>	Wi-Fi 802.11b/g/n(2.4GHz) & Ethernet 10/100/1000, DLNA(DMS,DMC,DMR)
<b>CD Ripping audio format</b>	WAV, FLAC
<b>Battery</b>	Capacity : 10.4A / Voltage : 7.4V(Normally) / Type : Li-Ion
<b>Dimension / Weight</b>	214[W] x 238[H] x 243[D](mm) / 11.4kg



Specifications and appearance can be changed without previous notice.

The Auto Spec has been measured by the Balanced of the Analog Out.

## Package contents

Components may be changed without notice to improve product performance and quality.



**AK500N**

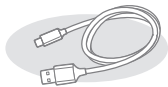

**USB cable  
for data transfer**



**Power code**

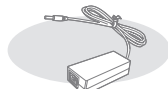

**Adapter**



**Antenna**



**T wrench**



**Quick Start Guide  
& Warranty Card**



**Protective Film**

**Power Code & Adapter:** Connect with the product to recharge the product.

**USB Cable for data transfer:** Connects the product to the computer and sends data.

**Antenna:** It is an antenna for wireless network connection. Please tighten it on the [ANT] terminal of the back of the product.

**T Wrench:** Use when combine or spate the body and stand of AK500N.

**Quick Start Guide:** A manual of basic methods of using the product.

**Product Warranty:** Please keep the Product Warranty well, because it is necessary when you apply for AS.

**Protective Film:** You can use for LCD protection.

**User Manual:** You can download User Manual from [<http://www.astellinkern.com> > Support > Download] or check from [Settings-Help] of the product.

## Name of each part

Appearance of the product and the printing, stamping contents may vary depending on a model.

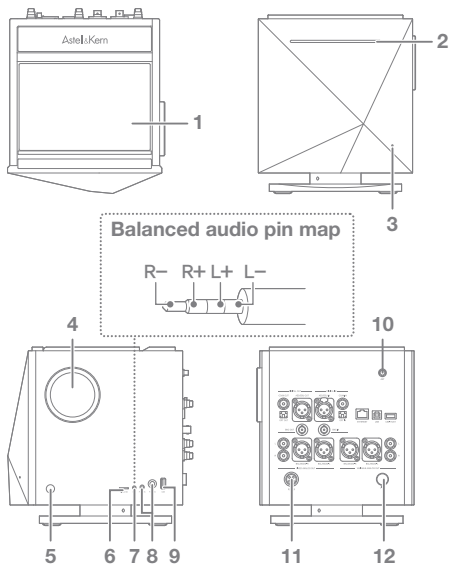

<b>1 Touch LCD</b>	Displays the screen, and you can touch the screen to operate.
<b>2 CD Insertion</b>	Push the CD to insert.
<b>3 Power LED</b>	Displays the Power On/Off status.
<b>4 Volume Wheel</b>	Turn the wheel to adjust the size of the sound.
<b>5 Power</b>	You can turn On/Off the power of the product.
<b>6 Micro SD Card Slot</b>	You can equip a Micro SD card into the product, and play music files of the MicroSD card.
<b>7 Balanced Port</b>	You can listen to the sound source by connecting the earphone and headphone which support the balance cable.
<b>8 Headphone/Earphone Jack Connector</b>	Output the sound through the earphone by connecting headphones/earphones.
<b>9 USB Host Connector</b>	You can connect a USB storage device to play music files on a USB storage device.
<b>10 Wireless Network Antenna</b>	Rotate the wireless network antenna to connect.
<b>11 Power Port</b>	Connect the power adapter.
<b>12 LED Power Jack Stands</b>	Attach the power LED stand. (It will be released in the future)

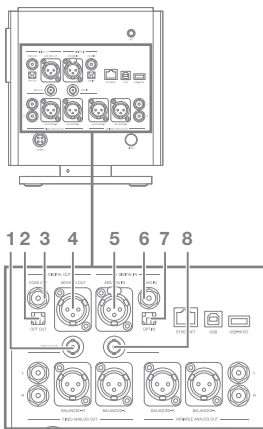

<b>Digital Out</b>	<b>1 BNC Output Port</b>	Connect a BNC output cable to the port to output to digital.
	<b>2 Optical Output Port</b>	Connect an optical cable to the port to output to digital.
	<b>3 Coaxial Output Port</b>	Connect a coaxial cable to the port to output to digital.
	<b>4 AES/EBU Output Port</b>	Connect an AES/EBU cable to the port to output to digital.
<b>Digital In</b>	<b>5 AES/EBU Input Port</b>	Connect an AES/EBU cable to receive a digital input.
	<b>6 Coaxial Input Port</b>	Connect a coaxial cable to the port to receive a digital input.
	<b>7 Optical Input Port</b>	Connect an optical cable to the port to receive a digital input.
	<b>8 BNC Input Port</b>	Connect a BNC input cable to the port to receive a digital input.

**!** Unable to adjust volume when Digital Out is selected.

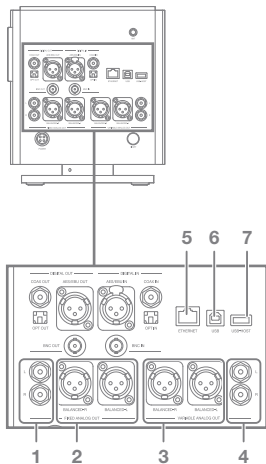

<b>Fixed Analog Out</b>	<b>1 Fixed RCA Port</b>	Connect RCA cable to the port to output to digital.
	<b>2 Fixed Balanced Port</b>	Connect Balanced cable to the port to output to analog.
<b>Variable Analog Out</b>	<b>3 Variable Balanced Port</b>	Connect Balanced cable to the port to output to analog.
	<b>4 Variable RCA Port</b>	Connect RCA cable to the port to output to analog.
<b>System 단자</b>	<b>5 Ethernet Port</b>	Connect a wired LAN cable to the port.
	<b>6 USB Port</b>	Connect USB B type cable to the port and the computer.
	<b>7 USB-HOST Port</b>	You can connect a USB storage device to play music files on a USB storage device.



Digital In/Out and Analog Out can be set in a notification bar or the [Settings-Sound-Sound In/Out].

Unable to adjust volume when Fixed Analog Out is selected.

## Managing power

### Connecting the Power

1. Connect the adapter and the power cord.
2. Connect the adapter cable to the [Power] on the rear panel, and turn the mounting ring to tighten.
3. Connect the power cord and then press the [Power] button on the product for 2-3 seconds.
4. [A] logo appears on the screen while the product is booted.

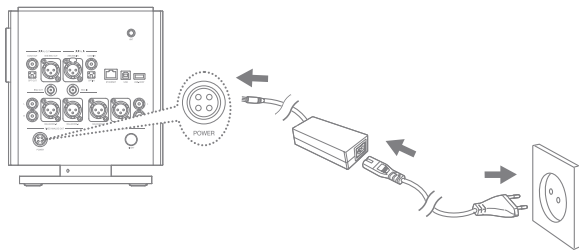

**!** Connect the power cord to a wall outlet after completing the connection of the product, an adapter, and the power cord. Use only the power cord and the adapter supplied in order to prevent malfunction or damage of the device. Keep unplugged the power cord from the outlet when you go out or you are not using the product for a long time. The product contents include suitable cables for each country such as the United States, Japan, Europe and the UK. Please separately check the national certification mark on the plug part, and use an appropriate power cable for each area to connect to an adaptor.

# Connections

## Earphones/Headphones

- Connect earphones or headphones to the [BAL], [PHONES] port of the side of the product.
- Connect earphones or headphones that support the balance cable to [BAL] port on the side of the product.
- You can use various earphones/headphones that fit  $2.5 \Phi$ ,  $3.5 \Phi$ ,  $6.5 \Phi$ .

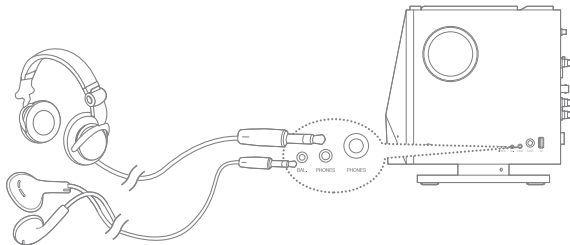

**!** Do not raise the volume to loud when connecting earphones or headphones.  
You can lose your hearing if you plug the earphones or headphones on your ears and listen to the large volume.



## Available Types of Cable

- **Balanced (XLR) Cable**

Balanced cables used in professional audio interfaces have better response capacity than regular cable, and can be transmitted from a long distance.

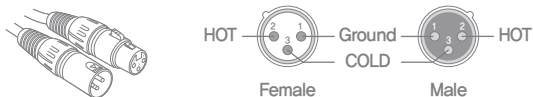

- **UnBalanced(RCA) Cable**

It is the most commonly used basic cable to transmit the audio signal.

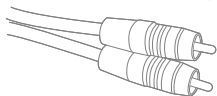

- **Optical/Coaxial/BNC Cable**

Optical cable and coaxial cable(Coaxial/BNC Cable) are the cables that can be used to connect to the digital inputs and outputs.

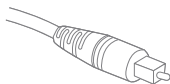

**Optical Cable**

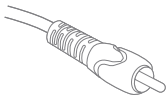

**Coaxial Cable**

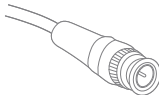

**BNC Cable**

## Connecting DIGITAL OUT

1. You can connect the product to an external amplifier device by using AES/EBU, Optical, Coaxial, BNC cables to [AES/EBU OUT], [OPT OUT], [COAX OUT], [BNC OUT] port of the rear panel.

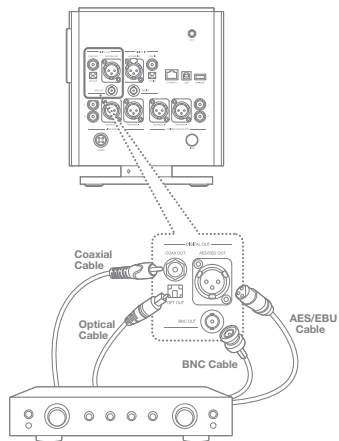

## Connecting DIGITAL IN

1. You can connect the product to an external source device by using AES/EBU, Optical, Coaxial, BNC cables to the [AES/EBU IN], [OPT IN], [COAX IN] port of the rear panel.

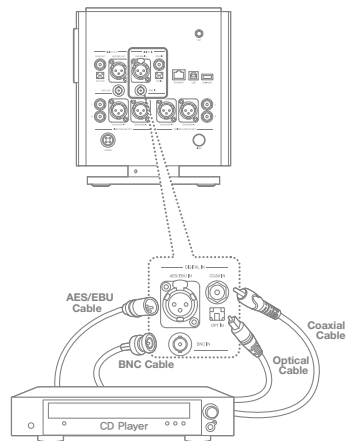

## Connecting Fixed Analog Out

1. You can connect 'Balanced' and 'RCA cable' to an external amplifier device from [FIXED ANALOG OUT] of the back the product.

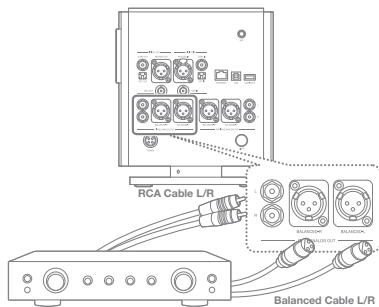

## Connecting Variable Analog out

1. You can connect 'Balanced' and 'RCA cable' to an external amplifier device from [VARIABLE ANALOG OUT] of the back of the product.

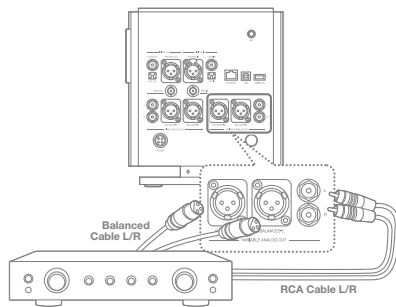

**!** This product supports both 'Fixed Analog Out' and 'Variable Analog Out'. If it is set to 'Fixed Analog Out', you can not adjust the volume in this product. Please check the interface port before using a cable. When connecting a cable, do not force strongly, and connect it by pushing it gently. Do not shake too strongly when it is connected to a cable.

## Inserting/Removing CD

1. Refer to the CD label and gently insert into the CD slot.
2. If you select [  ] from the notification bar on the home screen, the CD will be realised.

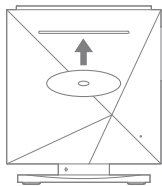

 This product does not support the CD Play function.

When you insert the CD, the CD-Ripping function will be activated.

### Cautions for CD insertion

- Do not put excessive force when inserting a CD. This can cause malfunction and CD breakage.
- If the CD is inserted incorrectly, the product can be damaged or the CD can not be separated.
- A damaged CD or a CD with foreign substances can generate a problem.

### Cautions for CD Separation

- Do not remove the CD during operation, it can cause a malfunction and a breakage of the CD.
- Static may occur during CD ripping depending on the CD's condition.

## Inserting/Removing the microSD Card

1. Place the microSD card in the slot like the figure and press gently.
2. If you choose [Safely Remove SD Card] from the notification bar on the home screen, the microSD card will be removed safely.
3. If you press the microSD card one more time, the card will be separated.

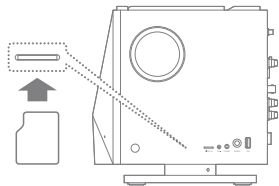

## Recommended microSD card

Brand: SanDisk, Transcent

**!** **Cautions for inserting the microSD card**  
Do not force the SD card. This may cause a malfunction of the product and damage to the microSD card.

Please do not repeatedly insert/remove the microSD card.

If the microSD card is not positioned properly, the product may malfunction or the card may become un-removable.

**Cautions for removing microSD card**

- Please remove the microSD card through 'Safe Removal'. If not, the memory or the system of the product can be damaged.

- Do not remove the microSD card while using the microSD card.

It can cause a deletion of data, a malfunction of the product, and damage to the microSD card.

**Other Cautions for using microSD card**

- If microSD card is not recognized or has malfunctioned, please reformat the card to the FAT32 system which is recommended.

- If you use other cards rather than recommended microSD card, a malfunction can occur.

- microSD card is not included in the component. You can purchase separately.

## Connecting USB Storage

1. Connect the USB storage device to the [USB] port on the side of the product.

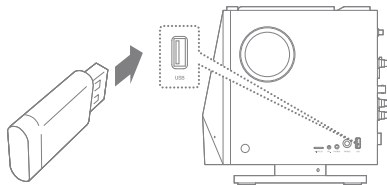

1. Connect the USB storage device to the [USB-HOST] port on the back of the product by using a USB cable.

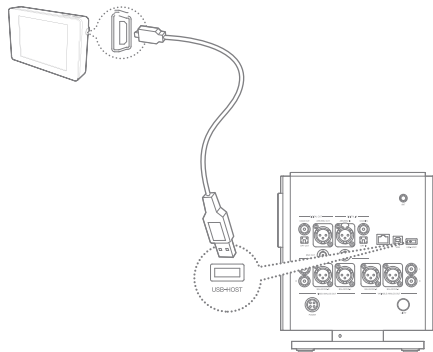

- !** Some products that require a separate driver installation or multiple drive generation(multi-card reader), etc. may not be supported.  
Some products that require a separate power source(external HDD, etc.) may not be supported.  
The USB host cable is optional.

## Connecting to a Wireless Network Antenna

1. Connect the antenna for the wireless network to [ANT] port of the product.

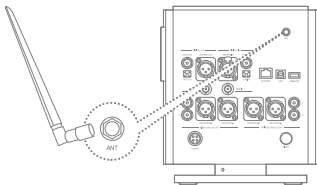

## Connecting to the Network

1. Connect the internet connections(ADSL, VDSL, cable model and wired/wireless router, etc.) to the [ETHERNET] port on the back of the product, or connect to an AP that provides WI-Fi.
2. Check the notification bar and the setting menu if network is connected or not.

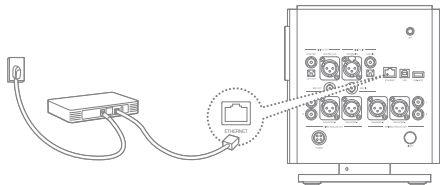

## Connecting to a Computer

1. Connect the [USB] port and a computer by using the supplied USB cable for data transfer.

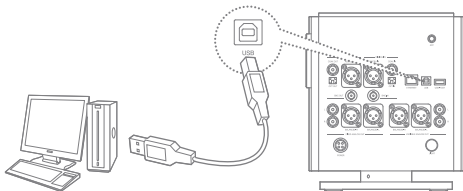

## Separating with the Computer

1. Check if there is a work in process between the product and the computer before disconnecting the USB cable for data transfer.

- !** Native DSD plays to PCM while connected to a PC as MTP.  
If it is connected to MTP via a USB cable while playing Native DSD, Native DSD will be terminated automatically.  
If you are a MAC user, please download a MTP program from [Support > Download of <http://www.astellinkern.com>] and install to use.  
Do not use a cable other than the USB cable supplied for data transfer. This may cause a malfunction.  
Please connect at the state all the features stopped, for a smooth connection of the computer and a USB cable for data transfer.  
Please connect to a high-power USB 2.0 port. The connection with a computer can be not good, if you connect a keyboard or a self-powered USB hub, etc.  
If you are a Windows XP user, you need Service Pack 2 or more, Windows Media Player 10 or newer version installation to recognize and use the USB disk.  
You can download the Service Pack and Media Player from [<http://www.microsoft.com>].  
If you disconnect the USB cable for data transfer during a work in process, it may cause fatal errors on the product.



## Copying a File(Folder) to the Product

1. If you select the files/folders to copy from a computer, drag and drop(Drop&Drop) to the drive added by the product, the selected files/folders will be copied.

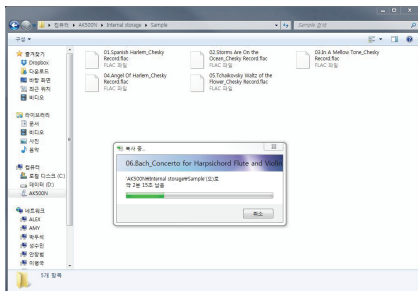

## Deleting a File(Folder) of the Product

1. Select files/folders to delete and click the right mouse key, then select [Delete].
2. If you click [Yes] in the [File/Folder Delete Confirmation] window, the selected file/folder will be deleted.

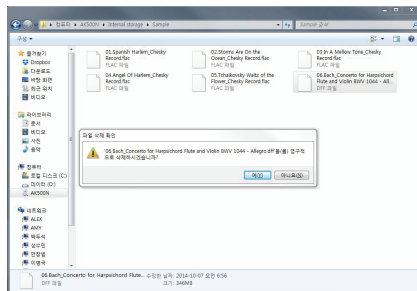

**!** Please connect the USB cable for data transfer correctly.

If you copy files/folders, or the computer is off or the USB cable for data transfer is disconnected while moving it, it may cause serious damage on memory.

The transmission speed can be slow depending on the computer and OS environment that you use.

If you copy or move a file during PCM to DSP playback, the sound may be distorted or break up.

# Upgrading the firmware

## Upgrading the Firmware of the Product

1. Connect the product to a wired or wireless network.
2. When the new firmware is verified, the firmware update instruction appears.
3. Select [Update], and select the item you want to update.
4. Follow the prompts on the screen to proceed the firmware upgrade.



Refer to page 56 for a network connection method.

If you move to another screen while downloading upgrade files, the download will be stopped.

Please do not turn off the network connection while downloading upgrade files.

It can cause serious damage to the system, because the upgrade file cannot be downloaded properly.

If an error occurs or notification bar is gone while downloading upgrade files, you can re-download the firmware via [Settings-Update-System Update].

# Basic operation

## Using the Touch LCD

1. The product is equipped with a touch screen LCD system that operates by a direct touch. If you touch the desired icon on the screen, the selected function will be operated.

**!** Do not use a sharp object or excessive force to prevent damage to the screen.

## Basic Setting

1. Set the language to be used in the language setting screen that is displayed when you turn on the power for the first time after purchasing the product, and then click [Next].
2. Set the time to use from the world time settings, and then click [Next].
3. The default setting will be completed if you click [Start], and the Feature Guide for using AK500N.
4. You can use the product, if you click [Start] after the function guide is finished.

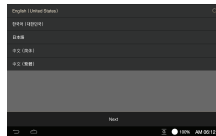

## Moving to the Previous Screen

1. Click [ $\rightarrow$ ] while using the product to move to the previous page.

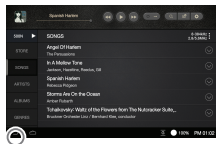

## Moving Up/Down from the List

1. Drag the screen [down to the top]/[top to the down] from the display list to move the list.

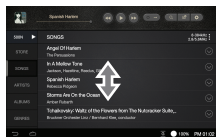

## Setting Sound In/Out

1. You can set in the notification bar screen or [Settings-Sound-Sound In/Out].



! If 'Sound In/Out' is connected to 'Digital In(Coax, OPT, AES/EBU, BNC), you can not output the sound with 'Digital Out'.

If you choose 'Digital In' from the 'Sound In/Out' selection screen, 'Digital Out' is not available.







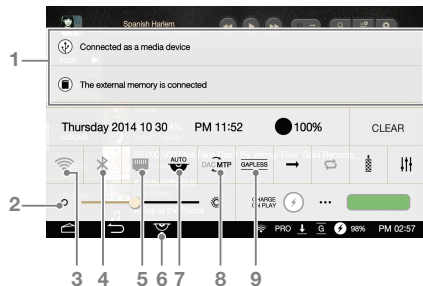

While 'Sound In/Out' is connected to 'Digital In(Coax, OPT, AES/EBU, BNC), the connection will be canceled and [CLOSE] menu will be activated, if you re-click the connected port icon.

The volume adjustment is only available if [BAL] and [PHONES] of the side and 'Variable Analog Out' from the 'Sound In/Out' selection screen.

# Notification bar

The Notification Bar will be displayed if you drag up and click the notification icon at the bottom.



- 1 Display of notification message** The content is displayed if there is a notification. The notification will disappear if you push the notification information aside.
- 2  Screen Brightness** Move the location of the Brightness Adjustment Bar to adjust the brightness of the screen.
- 3  Wireless Network** Turns on/off the wireless network.
- 4  Bluetooth** Turns on/off the Bluetooth to use Bluetooth remote control.
- 5  Ethernet** Turns on/off Ethernet.
- 6  CD Extraction** Extract the inserted CD from the CD slot. (Only activated when a CD is inserted)
- 7  CD Ripping** Turns on/off the automatic CD ripping function.
- 8  Computer Connection Mode** Select the run mode when connected to a computer.  
MTP: is connected to a computer, you can transfer media files.  
DAC: You can listen to music of PC via the product.
- 9  Gab-less** Turns on/off gab-less.

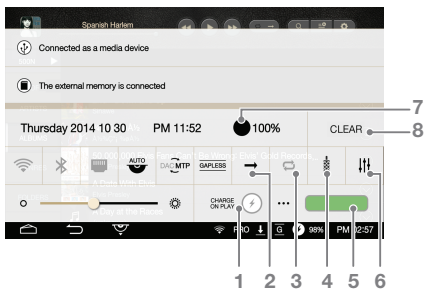

- 
- |   |   |  |
|---|---|--|
| 1 | ⚡ <b>Automatic Battery Charging Set</b> | Sets the automatic battery charging function while playback. |
|---|---|--|
- 
- |   |                    |  |
|---|--------------------|--|
| 2 | ➔ <b>Play mode</b> | Sets the playback mode.<br>➔ : Plays the music of the list being played in order<br>⌘ : Plays the music of the list being played in random order |
|---|--------------------|--|
- 
- |   |                      |   |
|---|----------------------|---|
| 3 | 🔄 <b>Repeat Mode</b> | Sets the repeat mode.<br>🔄 : Repeats playback of the list being played<br>🎵 : Repeats the currently playing music<br>🛑 : Turn off 'Repeat Mode' |
|---|----------------------|---|
- 
- |   |                       |                               |
|---|-----------------------|-------------------------------|
| 4 | 🔊 <b>Sound In/Out</b> | Indicates the setting screen. |
|---|-----------------------|-------------------------------|
- 
- |   |                           |  |
|---|---------------------------|--|
| 5 | 🔋 <b>Charging Battery</b> | When automatic battery charging function is off during playback, select Start to begin battery charging. |
|---|---------------------------|--|
- 
- |   |                  |  |
|---|------------------|--|
| 6 | <b>Sound Set</b> | Displays the sound setting(EQ, etc.) screen. |
|---|------------------|--|
- 
- |   |                                  |                                      |
|---|----------------------------------|--------------------------------------|
| 7 | ⚡ <b>Remaining Battery Power</b> | Indicates the current battery level. |
|---|----------------------------------|--------------------------------------|
- 
- |   |              |   |
|---|--------------|---|
| 8 | <b>CLEAR</b> | Removes a notification message displayed on the screen. |
|---|--------------|---|
-

## Music list screen

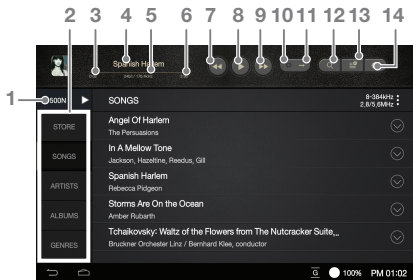

- |   |                             |  |
|---|-----------------------------|--|
| 1 | <b>MQS Streaming</b>        | Display the Network Server and Network Player list. Activate Server/Player in settings menu to use the function. |
| 2 | <b>List Display Method</b>  | The music list is displayed differently depending on how the list displayed in the left menu.                    |
| 3 | <b>Position Information</b> | Indicates the current playback position.   |
| 4 | <b>Title</b>                | Displays the song title. If ID3TAG does not exist, the file title is displayed.                                  |

- |    |                                |   |
|----|--------------------------------|---|
| 5  | <b>Progression State Bar</b>   | Displays the state of the progress. If you move the position of the bar, it moves to where you want.                                |
| 6  | <b>Play Time</b>               | Displays the total duration of the song.  |
| 7  | <b>Previous Music/Rewind</b>   | Short: Plays the previous song. Long: Rewinds the music being played.   |
| 8  | <b>Play/Pause</b>              | Pauses or replays the music   |
| 9  | <b>Next Music/Fast Forward</b> | Short: Plays the next song. Long: Forwards fast to the playing music.   |
| 10 | <b>Repeat Mode</b>             | Sets the repeat mode.   |
| 11 | <b>Playback Mode</b>           | Sets the playback mode.   |
| 12 | <b>Search</b>                  | Enter a search term in the search box to search for the file.   |
| 13 | <b>Current Play List</b>       | Displays the current playlist.  |
| 14 | <b>Set CD Ripping</b>          | Displays the setting screen. If you set CD Ripping as 'Manual' from the setting, an additional menu appears when you insert the CD. |

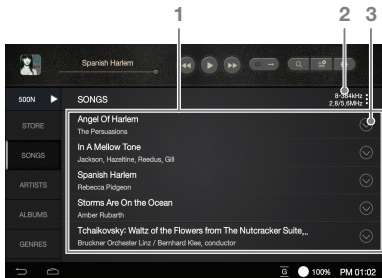

**1 Music List** Display a music list of the current position. Press the [⊙] next to the desired music to delete a file, add to the play list, or add to the current play list.

**2 Sort by List** You can select the music list sorting method as 'ALL/MQS/DSD/Ripping'. You can select the music list sorting method as 'Bit/Sample Rate'.

**3 Add-ons List** Displays the add-ones window of the music lists. The functions are displays differently by music retrieval scheme.

📄 : Copies the file. (Activates only in folders)

📁 : Moves the file. (Activates only in folders)

📌 : Adds the file to the play list.

🎵 : Adds the file to the current play list.

🏷️ : Changes the name.

(Activates only in folders)

🗑️ : Deletes the file.

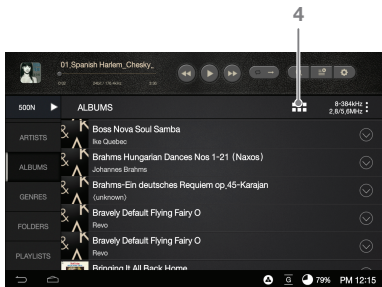

**4 Album List Display** You can choose the album list display method as 'Thumbnail/List'.



# Music playback screen

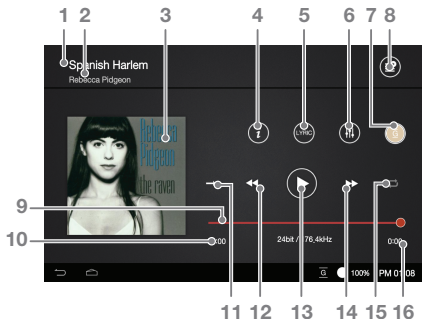

1	<b>Title Name</b>	Displays the title of the music. If ID3TAG does not exist, the file name is displayed.
2	<b>Artist Name</b>	Displays the name of the artist.
3	<b>Album Art</b>	Displays the album art
4	<b>i Information</b>	Displays the information about the currently playing music.

5	<b>LYRIC Lyrics</b>	Displays the lyrics.
6	<b>Sound Set</b>	Displays the sound set(EQ, etc.) screen.
7	<b>G Gap-less</b>	Turns on/off the gap-less.
8	<b>Current Playlist</b>	Displays the current playlist.
9	<b>Progression State Bar</b>	Displays the state of the progress. If you move the position of the bar, it moves to where you want.
10	<b>Play Time</b>	Displays the total duration of the song.
11	<b>→ Play Mode</b>	Sets the play mode.
12	<b>◀◀ Previous</b>	Short: Plays the previous song. Music/Rewind Long: Rewinds the music being played.
13	<b>▶/   Play/Pause</b>	Pauses or replays the music
14	<b>▶▶ Next Music/ Fast Forward</b>	Short: Plays the next song. Long: Forwards fast to the playing music.
15	<b>◁ Repeat Mode</b>	Sets the repeat mode.
16	<b>Play Time</b>	Displays the playing time. Touch to change a display of the remaining playtime.

# Listening to music

## Select Music

1. Select a music retrieval method from the menu located on the left to display the music list for that classification.
2. Press the music to play on the music list that appears on the screen to play music.

**!** You can browse the music by folders in the [Folder].  
Playback Time: About 7 hours (16bit/44.1kHz, Unbalanced output, Volume 75, EQ OFF, LCD OFF Standard)  
Continuous playback time is based on 1TB model.  
Continuous playback time varies with SSD capacity.  
Supported File Formats: WAV[8~384kHz(8/16/32bit)],  
FLAC[8~352kHz(8/16/24bit)]

## Listening to Music

- Turn the [Volume Wheel] to adjust the volume.
- Press [ **||** ] to pause, and [ **▶** ] to restart during playback.
- Press [ **◀◀ / ▶▶** ] to play the previous/next music during playback.
  - + You can play the previous/next music by dragging the album art image in the music playback screen in [up → down]/[down → up] direction.
- Press and hold the [ **◀◀ / ▶▶** ] to rewind/fast forward.
- Move the position of the progress bar during playback to move to the desired location.
- Press [ **↶** ] to display the previous screen.
- Press [ **⬅** ] to display the home screen.
- Press [ **☰** ] to display a list of currently playing music.

# Ripping the CD

## Ripping the CD Automatically

1. Insert the CD into the CD insertion slot of the product
2. Import the metadata information of the CD that is inserted in the Grace Notes.
3. When you have finished importing the information, CD ripping starts.
4. When ripping is complete and if you press [OK] in the results window, the CD automatically comes out from the insertion slot.

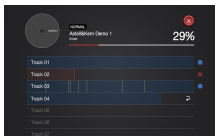

## Ripping the CD Manually

You can select auto/manual ripping from [Settings- CD Ripping- Automatic CD Ripping].

1. If you insert the CD to the insertion slot of the product, [CD Ripping] menu on the left menu, gets activated.
2. Press the [CD Ripping] menu, and select the ripping file format as FLAC or WAV.
3. If select the file format, it starts search for the Grace Note DB.
4. When DB search is completed, click [Start] to start ripping.
5. You can directly choose the song to rip in the selection box in front of each track.

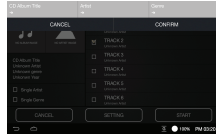
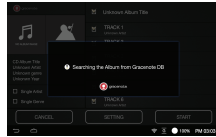
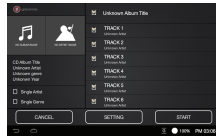
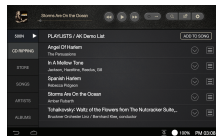

## CD Ripping Results

- ● : Tells CD Ripping is successfully completed.
- ✕ : Indicates a failure of CD ripping, because of a physical scratch generated in the CD, etc.
- ⚠ : Tells an error occurred, but CD ripping is completed through error correction.



To recall the Grace Note DB data, AK500N has to be connected to the network before ripping. Refer to page 56 for the network connection method.

Set the location of the ripped file from [Settings-CD Ripping]. If you have not set the location, it will be saved in the current folder.

It is possible there is not the relevant information about Grace Note, depending on the CD.

Grace Note DB search time may be longer depending on the network environment.

File formats and the ripping speed can be selected from [Settings > CD Ripping].

If you enable error-checking function in [Settings > CD Ripping] menu, it attempts to compensate for data errors several times.

So if you enable this function, the CD ripping becomes slow. If you rip a CD manually, press the song you want to change from the whole music information screen to select the name of the album, artist, and genre on the touch keypad.

During CD ripping, the playback will be stopped if WAV, FLAC files that are 24bit/352kHz or more are converted into DSD64.

## CD Ripping Screen

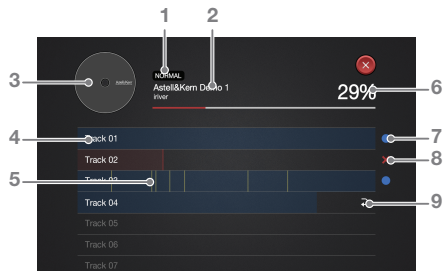

1	<b>Ripping Speed</b>	Displays the ripping speed.
2	<b>Album Information</b>	Displays the information about the album.
3	<b>Album Art</b>	Displays the album art.
4	<b>Ripping Progress Bar</b>	Displays the ripping progress.
5	<b>Ripping Error Information</b>	Displays the ripping error.
6	<b>Ripping Progress State</b>	Displays the ripping progress state.
7	<b>Ripping Success</b>	Displays the success of the ripping.
8	<b>Ripping Failure</b>	Displays the failure of the ripping.
9	<b>Skip Ripping</b>	Skips the ripping.

## Managing the current playlist

### Adding the song in the current playlist to the playlist

1. Press [⊕] next to the song, and select [≡].
2. You can add the selected songs to your playlist.
  - Add a playlist: Create a new playlist and add the songs you selected.
  - Add to the playlist: Select the playlist to add the songs that you selected to the list.

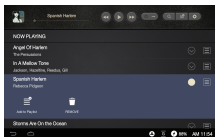

### Changing the music order of the current playlist

1. Press [≡] next to the song.
2. Hold [≡], and move the selected song to up/down to change the position of the song selected.

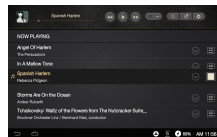

### Deleting songs in the current playlist

1. Select [⊕] next to the song.
2. Press [🗑️] to remove the selected song from the current playlist.

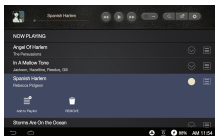

# Managing the playlist

## Creating the Playlist

1. If you select [Playlist] from the left menu, the playlist is displayed.
2. Select [Playlist], and press [Add Playlist] at the top.
3. If you set the name of the playlist, and click [OK], a new playlist will be added.

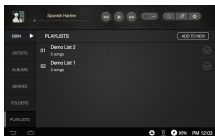

## Add a playlist to the current playlist

1. Press [⊖] next to the desired playlist from the playlist, and select [🔗].
2. Select the location you want to add.

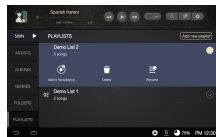

- Add after the current playlist: Adds the selected playlist at the end of the playlist.
- Add after the currently playing song: Adds the selected playlist after the current playing song.



You can also add a playlist to the current playlist in the following way:

- If you press and hold the desired playlist

from the playlist, a check box is displayed.

Select the check box, and then select [Add to the current playlist] on the top.



## Adding music to playlists

1. A playlist is displayed, if you press [Add Song] on the top of the playlist.
2. Check a select box in front of the music you want to add, and press [Add], then the selected music will be added to the playlist.

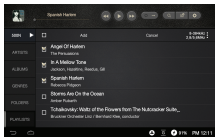

## Deleting a playlist

1. Press [⊖] next to the desired playlist from the playlist, select [🗑️] and press [OK], then the selected playlist will be deleted.



## Changing the name of the playlist

1. Select [⊖] next to the desired playlist from the playlist, and select [🗑️], then a window for changing name will be displayed.
2. Type a new name and press [OK], then the name of the playlist will be changed.

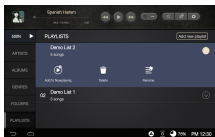

## Adding a song in the playlist to the current playlist

1. Select the desired playlist from the playlist, and select [☺] next to the song you want to add.
2. Press [⊕], and select the location you want to add.

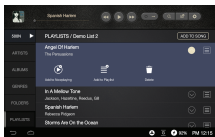

- Add after the current playlist: Adds the selected playlist at the end of the playlist.
- Add after the currently playing song: Adds the selected playlist after the current playing song.



You can also add a playlist to the current playlist in the following way:

- If you press and hold the desired playlist from the playlist, a check box is displayed. Select the check box, and select [Add to the current playlist] on the top.

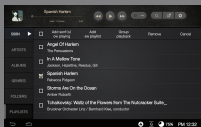

## Add a song in the playlist to the playlist

1. Select the desired playlist from the playlist, and select [☺] next to the song you want to add.
2. Press [≡], and add the selected song to the playlist you want.
  - Add a playlist: Create a new playlist and add the songs you selected.
  - Add to the playlist: Select the playlist to add the songs that you selected to the list.

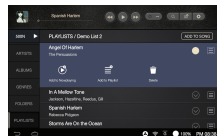

Songs in the USB memory or a USB external disk can be played in the folder menu, but they cannot be added to the play list.



## Searching files

### Searching files

1. If you press [⌘] on the top right of the playlist, a search bar will be displayed.
2. Select Songs/Albums/Artists you want to search.
3. Type search term in the search input window, and browse the file.

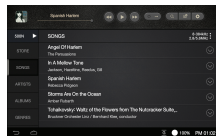

## Managing Files

### Folder Copy

1. Select [✓] next to the folder you want to copy.
2. Select [📄], and press [Paste]. Then the selected folder will be copied.

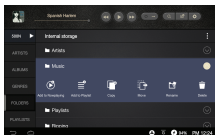

### Moving Folders

1. Select [✓] next to the folder you want to move.
2. Select [📄], and press [Paste]. Then the selected folder will be moved.

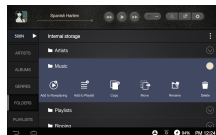

! If you press [✓] on the right of a music list, the music list add-ons window will be displayed. Copying a folder is only available if you selected [Folder] from the menu. You can make a new folder by pressing [New Folder].

## Deleting folders

1. Select [☺] next to the folder you want to delete.
2. If you press [🗑️] on the music list add-ons window, the selected folder will be deleted.

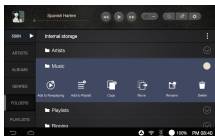

## Adding to the playlist

1. Select [☺] next to the folder you want to add to the playlist.
2. Select [☰] on the music list add-ons window, then select the list you want to add.
3. If you press [OK], the selected file will be added to the playlist.

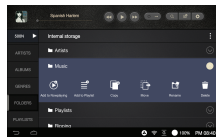

You can also add folders to the playlist in the following way:

- If you press and hold the folder you want to

add to the playlist, a check box appears in front of the folder list. Select the check box, and then select [Add to playlist] on the top.

This function remains available when folder is moved, copied or deleted.



## Adding to the current playlist

1. Select [ ⌵ ] next to the file you want to add to the current playlist.
2. If you select [ ⌵ ] on the music add-ons window, the selected file will be added to the current playlist.

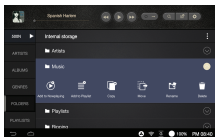

## Changing a name

1. Select [ ⌵ ] next to the folder you want to change the name.
2. If you select [ 📁 ] on the music add-ons window, a name-changing window will be displayed.
3. If you press [OK], the folder name will be changed.

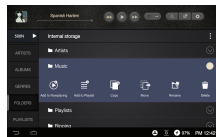

**!** The name can be changed only if you select one folder.  
Playlist applies only to the internal storage. It does not support an external storage.  
During a media scan, you can add to the playlist or the current playlist or modify.  
You can use the file browser navigation and playback during a media scan.

# MQS streaming

You can play or download the music from a PC on the same network via AK500N in real time.

## Installing MQS Streaming Server

1. Download MQS Streaming Server from [Support > Download of <http://www.astellnkern.com/>] depending on the version of the PC.
2. After running the setup file, install it according to the installation guide screen.
3. You can check the using method for MQS Streaming Server via the Help in the Server Program.

**!** PC/MAC must meet the following conditions.

### Supported PC Specifications

- OS: Windows XP, Windows 7, 8(32, 64 bit)

### Supported MAC Specifications

- MAC OS 10.7 (Lion) or later version

## Choosing MQS Streaming Server

1. Install the MQS streaming server from the PC, and run it.
2. If you press [500N] on the left menu when AK500N and PC are connected in the same network, the PC list will be displayed on the [Network Server] list.
3. If you select the PC you want to connect, the left menu will be displayed as the list that PC has.
4. If you select [Network Player], wireless network devices that are on the same network will be searched. If you select those devices, you can output the sound.

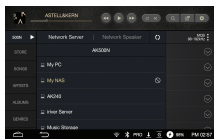

**!** You can connect to the NAS products that support DLNA function.

## Wireless Control PP

1. You can operate this product wirelessly through the application.
2. Recommended Control APP: Android(BubbleUPnP) / iOS(Sitecom Media Controller, Network Audio Remote)
3. You can download relevant applications from Google Play Market and Apple App Store.

For the use method of applications, please refer to the help for the application.

**!** In order to connect to Network Server and Network Player, AK500N and the product you want to connect must be connected in the same network.

For the detail connecting method of the network player or Wi-Fi speaker, please refer to the user guide of the each product.

When connected to a wireless network, the streaming can be disconnected or the next song play can be slow depending on the network condition.

If the streaming is operated when AK500N, PC, smartphone/tablet are all connected to a Wi-Fi, the connection may not be smooth or the song can be stopped depending on the network condition. (Please set AP as 802.11/g or 802.11/n.)

If other work is in progress on the server PC, the server reaction can be slow.

If you are streaming and downloading at the same time, AK500N reaction can be slow depending on the wireless network or the condition of the server PC.

If you touch the item being downloaded from the notification bar or turns off the MQS streaming function, the download will be stopped.

When you operate this product with wireless control APP, the data in the USB memory stick or USB external disks are not visible in the wireless control APP.

## Purchasing music in the store

### Purchasing music

1. Connect AK500N to the network.
2. If you press [Store] in the menu, and select 'Groovers' from the list appears, the APP will be activated.
3. You can check the using method through the user guide and help in the STORE.



For the network connection method, refer to page 56.

The currently supported STORE is 'Groovers'.

'Groovers' of the store menu is displayed if you currently select [Setting> Date and Time > GMT+09:00, Korea Standard Time].

Purchase/Payment via 'Groovers' is only available in the Republic of Korea.

## Using USB DAC function

USB DAC function is a function to recognize AK500N via a sound card and listen to sound through the earphone port of AK500N.

### USB DAC Specifications

- Supported USB DAC OS
  - + Windows XP (32bit) / Windows 7 (32bit / 64bit) / Windows 8 (32bit / 64bit) / Mac OS 10.7 (Lion) or later
- USB DAC Support Specifications
  - + Supported formats: WAV, FLAC, WMA, MP3, OGG, APE (Normal, High, Fast), AAC, ALAC, AIFF, DFF, DSF + Sample Rate: 44.1Khz ~ 192Khz
  - + Bit rate: 16bit / 24bit
  - + Supported DSD Specifications: DSD64, DSD128
- You can adjust the sound volume output through the volume wheel on the AK500N.



The sound does not play when you set exceeds the '24bit 192kHz'.

If the USB usage is a lot or PC becomes slow, the sound may not be played.

When playing video sources, the sync of video and sound may not fit, depending on the quality of the original and output, and the using circumstance.

When USB DAC is operating, you cannot output to the Digital Out (AES / EBU, Optical, Coaxial, BNC).

You cannot adjust the sound with Windows Basic Volume, but you can adjust the volume with the volume wheel or the volume of the program you are using.

## Installing USB DAC

1. Set [Settings-Connecting USB] as [DAC input].
2. Connect the product and a PC by using a USB cable for data transfer.
3. Run the 'Setup.exe' file on the Driver.
4. Press [Next] if the following screen appears.
  - When the following screen appears, please check if [Settings-Connecting USB] is set as [DAC Input].

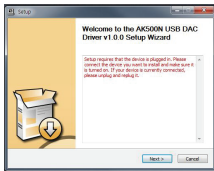
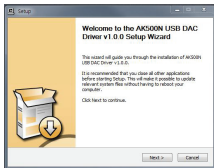

5. Press [Browser] to set the folder to install the driver, and then press [Install].
6. If the following screen is displayed, press [Finish] to complete the installation.

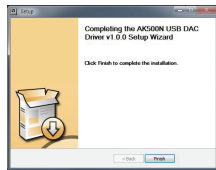
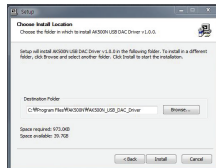

<After installing the driver>



7. According to the operating system, you can change the default device to output the sound with the following methods:

- XP: Change the default sound playback device to [AK500N USB DAC] from 'Control Panel> Sounds and Audio Device'.
- 7/8: Select [AK500N USB DAC] from 'Control Panel>Sound>Playback' tab, and select [Set as Default Device] on the bottom.

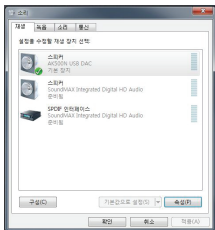

- MAC OS X: Select the Output tab from the sound menu under the System Preferences, and select [AK500N USB DAC].

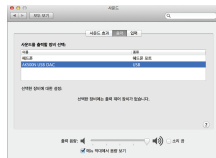

**!** You need to complete this step, only if you are using AK500N with USB DAC for the first time. You do not need a separate follow-up to select AK500N for the sound output. If you connect to USB DAC when playing PCM or Native DSD, the music being played will be stopped automatically. If you press [Connect to a Media device] on the screen when it is connected to the USB DAC, the USB DAC will be disconnected, and reconnect to MTP mode again. If you reboot AK500n after the connection to the USB DAC, it will be changed MTP mode again. For high sound quality, it is recommended to change the default format to [24bit, 192000Hz(Studio quality)] on the advanced tab, after clicking the 'Properties' button of [AK500N USB DAC] from Panel>Sound in Windows 7/8.

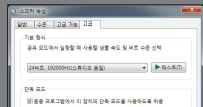

# Using bluetooth

## Bluetooth on/off

1. Please refer to the instruction manual of the Bluetooth remote control handset for a pairing.

## Pairing Bluetooth

1. Select the Bluetooth remote control you want to pair from the list you can use.

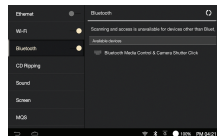

### ! Supported Bluetooth Specifications

- Supported profiles: A2DP (Only Bluetooth remote control can be connected.)

Do not turn off the power during the Bluetooth connectivity.

If Bluetooth is malfunctioning, turn off the power of the Bluetooth device, and turn it on again.

The registration method can be different depending on a Bluetooth device, so please refer to the instruction manual of each device when connecting.

Please proceed at around 20cm when connecting products and Bluetooth devices.

If the product and the Bluetooth are more than 2 meters away, the connection will be broken. (The distance can be different depending on the operating environment and the Bluetooth model.)

Interference can occur while using a Bluetooth.

Abnormal motion and noise may occur depending on the Bluetooth operation environment and the charge status of the device.



- If a part of body touches the product or the electric wave transmitter of the Bluetooth headset external device.
- If the received power changes by the electric wave obstructions such as walls, corners, partitions
- If there is the interference of the device using the same frequency band such as medical devices, microwave ovens, wireless LAN, etc.

# Settings

You can manually set your own production environment. Set menu structure may vary depending on the firmware version.

## Settings

1. Select [AK500N-Settings] on the home screen.
2. Set by selecting the desired item.

 You can also select the setting menu by selecting [  ] on the top, or [Notification bar] screen at the bottom of the screen.

## Ethernet

- Connect or disable the wired network.
  - Auto IP: IP is set automatically.
  - Manual IP: Set by directly entering information such as IP address, DNS.

## Wi-Fi

- Connect or disable the wireless network.

 Please refer to the page 56 for a detail method of setting the network.

## Bluetooth

- Connect or disable the Bluetooth remote control.

 Please refer to [Using Bluetooth] on the page 45 for a detail method of setting the Bluetooth.

## Ripping the CD

- Automatic CD Ripping: Set an automatic CD ripping.
- Manual CD Ripping: If you set the 'Manual CD Ripping', [CD Ripping] menu will be activated after the device recognizes the CD from the CD insertion slot.
- Ripping folder: Set the folder to save the ripped files.
- Ripping file format: Set the format of the file for ripping.
- Ripping speed: Set the ripping speed.
- Set Error checking: Turn on/off the function that checks errors while ripping.

 This product does not support playing a CD. If you activate the Error checking function, it will attempt to compensate for data errors for several times. So the CD ripping speed will be slow if you activate this function.

## Sound

- Equalizer: Set the equalizer to suit your tastes.
  - PRO EQ: Recommend Preset EQ by experts
  - USER EQ: Change the height of the equalizer on your tastes
- Sound In/out: Connect or disconnect Sound in/out
  - ⚠ If Sound In/Out is connected to Digital In(Coax, OPT, AES / EBU, BNC), you cannot output the sound as 'Digital Out'.
    - If you select 'Digital In' on the 'Sound In/Out' select screen, you cannot select 'Digital out'.
    - If 'Sound In/Out' is connected to 'Digital In(Coax, OPT, QES/ EBU, BNC)', it will be disconnected if you click the icon of the connected port again, and [CLOSE] menu on the bottom will be activated.
  - ⚠ You can only adjust the volume if 'Variable Analog Out' and [BAL], [PHONES] on the left side is selected on the 'Sound In/Out' selecting screen.
- Gap-less: Plays music files after the currently playing music and continue to the next file in a row without interruption.
  - It only works if the currently playing music and the following music have the same specification (the sample rate, bit, channel).

- Balance Output: Set the left/right balance of the sound output.
- PCM to DSD: Converts PCM file to DSD64 data, and turns on/off the playing function.

**!** It does not convert PCM files in the internal storage to DSD64 files. The equalizer is not applied when playing DSD. Using the equalizer function can slow down the operation of the product. For details on how to set up the equalizer, please refer to the page 57-58.

- ⚠ In order to use the PCM to DSD feature, you have to activate it from 'Settings> Sound'. This feature supports only WAV, FLAC files with DXD format. (DXD format means WAV, FLAC files with 24bit / 352kHz or more.)
- ⚠ If Sound In / Out is connected to the Digital Out (Coax, OPT, AES / EBU, BNC), Native DSD cannot be played.
  - If it is set to Digital Out, Native DSD will automatically be changed to PCM and played.
  - If it is set to Digital Out DXD will automatically be changed to PCM and played.If it is played or paused as Native DSD, you cannot select 'Digital Out' from 'Sound In/Out'.

## Screen

- Screen Brightness: Set the brightness of the screen.
- Screen Off: Set the screen off time in 6 steps.

## Server/Player

- Server/Playe : Server/Player function is available.
- MQS Server/Player Setting : Set Network server & player specific features.
  - 500N Server : If you turn off the network server, AK500N is not found in other product.
  - Network Server Name : Set the name of the server.
  - 500N Player : If you turn off the network player, AK500N is not found in other product.
  - Network Player Name : Set the name of the player.
- Download folder settings: Set the saving location when downloading files.

## Date and Time

- Set the date and the time.

## Language

- Set the language.
  - Korean, English, Japanese, Chinese(Simplified/Traditional), German are supported.

## Power

- Charging during playback: If you activate the charging option during playback, the battery is automatically charged even while playing.
- Enable to set automatic shutdown and sleep timer.



If you charge when battery status is less than 5% and the power is completely off, it takes about 3 hours to fully charge the battery.  
Battery charging time is based on 1TB model.  
Charging time varies with SSD capacity.  
Automatic shutdown is not supported during set operation.  
Playback stops at the sleep specified time.

## Connecting to USB

- Media devices (USB DISK): You can transfer media files when it is connected to a computer.
- DAC Input: You can listen to music of the PC through the product.

## Update

- System Update: Updates the system when there is a new update.

## System Information

- System Information: You can check the model number of the product, Firmware version, Memory usage information, the license of the product, and you can mount the microSD card/USB Storage or delete the data.

**!** Formatting the microSD card will delete all the data on the memory card. Be sure to backup any important files before formatting.

When formatting the microSD card from a computer, be sure to select the FAT32 system.

Internal memory capacity specifications differ depending on OS. Therefore, the capacity may be different.

SSD 4TB model with RAID5 uses about 1TB for data backup, which makes this region unavailable as user space.

## Initialization

- Database Initialization: Initialize the database within the product.  
The database initialization time may be longer depending on the number of products within the file.
- Reset: Reset the custom setting to the factory defaults.
- Factory Reset: The device will be reset to the factory settings, and all data will be deleted.

**!** RAID5 reconstruction after disk failure requires long hours for 4TB models configured for RAID5.  
Never turn off the power while factory reset is in progress.  
Files cannot be transferred from a PC to the AK500N while RAID5 reconstruction is in progress.

## HELP

HELP : Select Help to find a manual in selected language.

## Connecting to the network

### Connecting to a wireless network

1. If you press and hold [📶] in the notification bar, or turns on [Settings – Wireless Network], the AP lists of available connection appear.
2. If you choose the AP to connect, the wireless network will be connected.
  - You may need to type the key index and network key according to the AP setting.
3. If you press and hold [Modify Network] with the connected AP, you can modify the AP history.

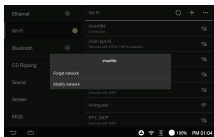
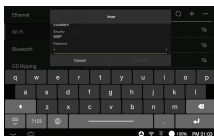
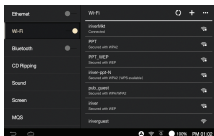

**!** You cannot use if you need an additional certification except wireless network connection, such as a web browser certifications. It supports channels up to 1-13.

### Connecting to a wired network

1. Connect the wired LAN cable to the [ETHERNET] on the back of the product.
2. If the IP information is confirmed in the IP address field, you can use the network.
3. If you want to change the IP address, click [Change] button, type the information such as IP address, DNS, and then click [OK].

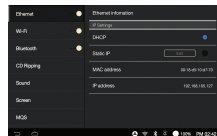

**!** It is recommended to use a wired network for smooth network feature utilization. If you use a wireless network feature, please set AP to connect to this product as '802.11/g' or '802.11/n'.

## Setting the equalizer

### Setting the equalizer

1. Activate the equalizer menu at [Settings – Sound – Equalizer].
2. Press [PRO EQ] on the bottom.
3. Select [Create] on the bottom.

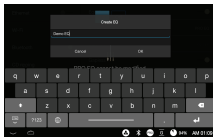
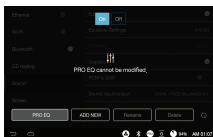
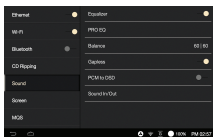

4. Set the name of the equalizer, and select [OK].
5. Set by changing the height of the equalizer to suit your tastes.





## Reset Equalizer

1. Press [ ⌘ ] to reset the equalizer.

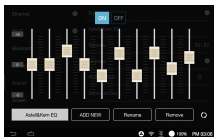

## Deleting Equalizer

1. Select the equalizer you want to delete.
2. Press [Delete] on the bottom of the equalizer, and press [OK] to delete the selected equalizer.

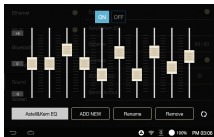

## Renaming the equalizer

1. Press [Rename] on the bottom of the equalizer, and type a new name.
2. If you press [OK] after typing a new name of the equalizer, the name of the equalizer will be changed.



## Trouble shooting

### Check!

1. The device won't turn on.
  - Please check if the power supply is correctly connected.
2. The operation of the product is unstable.
  - If you press and hold the power button on the side longer than 10 seconds, the product will be turned off. Please turn on the product again and check.
3. The screen turns off repeatedly.
  - After a certain period time, the screen turns off to reduce power consumption when playing the file. Set the time on [Settings – Power- Screen off].
4. The screen is not displaying properly.
  - Check whether debris is on the screen.
5. There is no sound or there's static.
  - Verify that the volume isn't set to [0].
  - Check that the earphones are plugged in properly, and make sure debris isn't in the port or on the plug.
  - Verify that the music file is not corrupted.
  - Verify that the audio settings have been properly set (balanced, line out, etc.)
6. File will not playback or a specific file causes instability.
  - The Following may occur due to the condition of the file:
    - Playback is unstable or difficult.
    - The device may not function properly.
    - The file may sound different from a computer.
    - There may be a difference in the performance of playback or other functions.
    - The file may not be compatible with playback specifications.
  - A file conversion or using a different file is recommended.

## Copyright

iriver Limited retains the rights to patents, trademarks, copyright, and other intellectual property rights related to this manual. No contents of this manual may be copied or duplicated in any form or by any means without the prior written consent of iriver Limited. Using or reproducing in whole or part, the contents of this document is subject to penalties. Software, audio, video, and any copyrighted contents are protected in accordance with copyright laws.

Unauthorized reproduction or distribution of the copyrighted contents from this product is the legal responsibility of the user.

Companies, organizations, products, people, and events used in the examples are not based on actual data. It is not the intention of iriver Limited to correlate any companies, organizations, products, people, and events with this manual. It is the responsibility of the user to comply with applicable copyright laws.

© 1999-2014 iriver Limited. All rights reserved.

## Certifications

KCC/FCC/CE/TELEC

Class B Device (Communication equipment for residential use): This is a Class B Device and is registered for EMC requirements for residential use. This device can be used not only in residential areas but in all other areas.



### FCCID : QDMDPF11

This device complies with Part 15 of the FCC Rules, Operation is subject to the following two conditions: (1) this device may not cause harmful interference, and (2) this device must accept any interference received, including interference that may cause undesired operation. Changes or modifications not expressly approved by the party responsible for compliance could void the user's authority to operate the equipment.

Changes or modifications not expressly approved by the party responsible for compliance could void the user's authority to operate the equipment.

(b) For a Class B digital device or peripheral, the instructions furnished the user shall include the following or similar statement, placed in a prominent location in the text of the manual:

NOTE: This equipment has been tested and found to comply with the limits for a Class B digital device, pursuant to part 15 of the FCC Rules. These limits are designed to provide reasonable protection against harmful interference in a residential installation.

This equipment generates, uses and can radiate radio frequency energy and, if not installed and used in accordance with the instructions, may cause harmful interference to radio communications. However, there is no guarantee that interference will not occur in a particular installation. If this equipment does cause harmful interference to radio or television reception, which can be determined by turning the equipment off and on, the user is encouraged to try to correct the interference by one or more of the following measures:

- Reorient or relocate the receiving antenna.
- Increase the separation between the equipment and receiver.
- Connect the equipment into an outlet on a circuit different from that to which the receiver is connected.
- Consult the dealer or an experienced radio/TV technician for help

### **Body-Worn operation**

This device was tested for typical body-worn operations with the back of the portable music player kept 5mm. from the body. To maintain compliance requirements, use only belt-clips, holsters or similar accessories that maintain a 1cm separation distance between the user's Body and the back of the Portable music player, including the antenna.

The use of belt-clips, holsters and similar accessories should not contain metallic components in its assembly. The use of accessories that do not satisfy these requirements may not comply with CE RF exposure requirements, and should be avoided.

### **Body-worn accessory exposure conditions**

“Specific information must be included in the operating manuals to enable users to select body-worn accessories that meet the minimum test separation distance requirements. Users must be fully informed of the operating requirements and restrictions, to the extent that the typical user can easily understand the information, to acquire the required body-worn accessories to maintain compliance. Instructions on how to place and orient a device in body-worn accessories, in accordance with the test results, should also be included in the user instructions. All supported bodyworn accessory operating configurations must be clearly disclosed to users through conspicuous instructions in the user guide and user manual to ensure unsupported operations are avoided. All body-worn accessories containing metallic components must be tested for compliance and clearly identified in the operating manual. The instruction must inform users to avoid using other body-worn accessories containing metallic components to ensure RF exposure compliance.”

**Disclaimers** The Manufacturer, importer, and distributor shall not be liable for damages including accidental and personal injury due to the improper use or operation of this product. The information in this user manual was written based on current product specifications. The manufacturer, iriver Limited, is currently adding new complementary features and will continue to apply new technologies in the future. All standards are subject to change without prior notice.

There is no warranty against data loss due to the use of the product.

**Trademarks** Windows 2000, Windows XP, Windows 7, Windows 8, Windows Media Player are Trademarks of Microsoft corp.

**Gracenote** This application or device contains software from Gracenote, Inc. of Emeryville, California (“Gracenote”). The software from Gracenote (the “Gracenote Software”) enables this application to perform disc and/or file identification and obtain music-related information, including name, artist, track, and title information (“Gracenote Data”) from online servers or embedded databases (collectively, “Gracenote Servers”) and to perform other functions. You may use Gracenote Data only by means of the intended End-User functions of this application or device.

You agree that you will use Gracenote Data, the Gracenote Software, and Gracenote Servers for your own personal non-commercial use only. You agree not to assign, copy, transfer or transmit the Gracenote Software or any Gracenote Data to any third party. YOU AGREE NOT TO USE OR EXPLOIT GRACENOTE DATA, THE GRACENOTE SOFTWARE, OR GRACENOTE SERVERS, EXCEPT AS EXPRESSLY PERMITTED HEREIN. You agree that your non-exclusive license to use the Gracenote Data, the Gracenote Software, and

Gracernote Servers will terminate if you violate these restrictions. If your license terminates, you agree to cease any and all use of the Gracernote Data, the Gracernote Software, and Gracernote Servers. Gracernote reserves all rights in Gracernote Data, the Gracernote Software, and the Gracernote Servers, including all ownership rights. Under no circumstances will Gracernote become liable for any payment to you for any information that you provide. You agree that Gracernote, Inc. may enforce its rights under this Agreement against you directly in its own name.

The Gracernote service uses a unique identifier to track queries for statistical purposes. The purpose of a randomly assigned numeric identifier is to allow the Gracernote service to count queries without knowing anything about who you are. For more information, see the web page for the Gracernote Privacy Policy for the Gracernote service.

The Gracernote Software and each item of Gracernote Data are licensed to you “AS IS.” Gracernote makes no representations or warranties, express or implied, regarding the accuracy of any Gracernote Data from in the Gracernote Servers. Gracernote reserves the right to delete data from the Gracernote Servers or to change data categories for any cause that Gracernote deems sufficient. No warranty is made that the Gracernote Software or Gracernote Servers are error-free or that functioning of Gracernote Software or Gracernote Servers will be uninterrupted. Gracernote is not obligated to provide you with new enhanced or additional data types or categories that Gracernote may provide in the future and is free to discontinue its services at any time.

GRACENOTE DISCLAIMS ALL WARRANTIES EXPRESS OR IMPLIED, INCLUDING, BUT NOT LIMITED TO, IMPLIED WARRANTIES OF MERCHANTABILITY, FITNESS FOR A PARTICULAR PURPOSE, TITLE, AND NON-INFRINGEMENT. GRACENOTE DOES NOT WARRANT THE RESULTS THAT WILL BE OBTAINED BY YOUR USE OF THE GRACENOTE SOFTWARE OR ANY GRACENOTE SERVER. IN NO CASE WILL GRACENOTE BE LIABLE FOR ANY CONSEQUENTIAL OR INCIDENTAL DAMAGES OR FOR ANY LOST PROFITS OR LOST REVENUES.

© Gracernote, Inc. 2009

Portions of the content are copyright © of Gracernote or its providers.