

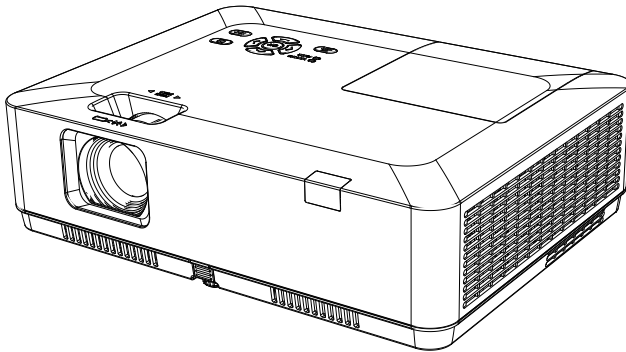

Regulatory Model		
P160	XGA Models	IN1004, IN1014
P161	XGA Models	IN1024, IN1034, IN1044
P162	WXGA Models	IN1026, IN1036, IN1046
P163	WUXGA Models	IN1029, IN1039, IN1049, IN1059



- Before using the product, please read these instructions carefully, and kept them safe for future reference.
- OSD options and pictures shown in this document may differ slightly from your product.
- Changes to this manual may be made without notice.



**UK
CA**



CE EAC

HDMI™
HIGH DEFINITION MULTIMEDIA INTERFACE

InFocus makes no representations or warranties with respect to this manual and, to the maximum extent permitted by law, expressly limits its liability for breach of any warranty that may be implied to the replacement of this manual with another. Furthermore, InFocus reserves the right to revise this publication at any time without incurring an obligation to notify any person of the revision.

The information provided in this documentation contains general descriptions and/or technical characteristics of the performance of the products contained herein. This documentation is not intended as a substitute for and is not to be used for determining suitability or reliability of these products for specific user applications. It is the duty of any such user or integrator to perform the appropriate and complete risk analysis, evaluation and testing of the products with respect to the relevant specific application or use thereof. Neither InFocus nor any of its affiliates, subsidiaries or licensees shall be responsible or liable for misuse of the information that is contained herein. If you have any suggestions for improvements or amendments or have found errors in this publication, please notify us.

All pertinent state, regional, and local safety regulations must be observed when installing and using this product. For reasons of safety and to help ensure compliance with documented system data, only the manufacturer shall perform repairs to components. Failure to observe this information can result in injury or equipment damage.

InFocus shall not be liable for any damages or problems arising from the use of any options or any consumable products other than those designated as original InFocus products or InFocus approved products by InFocus.

InFocus shall not be held liable for any damage resulting from electromagnetic interference that occurs from the use of any interface cables other than those designated as InFocus approved Products by InFocus.

Copyright © 2021 InFocus

All rights reserved. No part of this publication may be reproduced, distributed, or transmitted in any form or by any means, including photocopying, recording, or other electronic or mechanical methods, without the prior written permission of the publisher. For permission requests and for requests for improvements or amendments to our users guides or other literature contact us via our website contract page.

<https://infocus.com/support/contact/>

This Projector is designed with the most advanced technology for portability, durability, and ease of use. This projector has built-in multimedia features, and support the LCD technology by using the colour depth of 1.07 billion colour.

Simple computer system setting

The projector has a multi-scan system to conform to almost all computer output signals quickly. Up to WUXGA resolution can be accepted.

Useful functions for presentations

The digital zoom function allows you to focus on the crucial information during a presentation.

Light source mode

Brightness of the projection lamp can be selected.

Logo function

The Logo function allows you to customize the screen logo. You can capture any image on the screen.

Multilingual menu display

The screen menu of the projector is available in 26 languages: English, German, French, Italian, Spanish, Polish, Swedish, Dutch, Portuguese, Japanese, Simplified Chinese, Traditional Chinese, Korean, Russian, Arabic, Turkey, Finland, Norway, Denmark, Indonesia, Hungary, Czech Republic, Kazakhstan, Vietnamese, Thai, Farsi.

Convenient Maintenance Functions

Lamp and filter maintenance functions provide for better and proper maintenance of the projector.

Security function

The Security function helps you to ensure security of the projector. With the Key lock function, you can lock the operation on the control panel or remote control. PIN code lock function prevents unauthorized use of the projector.

Auto setup function

This function enables input source search, AUTO PC adjust and AUTO Keystone by simple pressing the AUTO button on the remote control.

Colourboard function

Adjust the projectors light and colour output settings when projecting on to a coloured surface or screen.

Power management

The Power management function reduces power consumption and maintains the lamp life.

Closed caption

Closed captions are a text version of the spoken part of a movie, or computer presentation. **Closed captioning** was developed to aid hearing-impaired people, but it's useful for a variety of situations. You can turn the feature on or off and switch the channels.



Caution

- The screen menu and images in the manual may slightly differ from the real product.
- The manual is subject to change without prior notice.







Disclaimer.....	2
Features and design.....	3
Content.....	4
Safety operation guideline.....	7
Safety instructions.....	7
Chemical Substances table.....	8
Air ventilation.....	12
Place your projector correctly.....	12
Moving your projector.....	13
Compliance.....	14
Accessory.....	15
Name and function of your projector.....	16
Front, Top.....	16
Rear.....	16
Bottom.....	16
Terminals.....	17
Keypad controls and indicator lights.....	19
Remote control.....	20
Installing batteries in the remote control.....	21
Remote control operation range.....	21
Installation.....	22
Set up your projector.....	22
Adjust the projected image.....	25
Connect to PC (digital and analogue RGB).....	26
Connect to video equipment.....	27
Connect to audio equipment.....	28
Connect to USB (USB-A – USB-B or USB-C – USB-B).....	29
Connect the AC power cord.....	32
Basic operation.....	33
Power on your projector.....	33
Power off your projector.....	34
How to operate the OSD.....	35
Menu item overview.....	36
Adjust the Projector Zoom and Focus.....	37
Auto setting function.....	38
Keystone adjustment.....	38
Volume adjustment.....	39
Remote control operation.....	40
Input selection.....	42
Display.....	44
Auto PC adj.	44
Fine sync.....	44
H Position.....	44
V position.....	45
H.Size.....	45
Aspect.....	45

Project way	46
Menu position	47
Background display	48
System	48
Colour adjust	50
Image mode	50
Colour adjust (For PC.).....	51
Colour adjust (For Video).....	52
Setting	53
Direct power on	53
Standby mode	53
High land	54
Light source mode.....	54
Cooling fast.....	55
Closed caption.....	55
Key lock.....	56
Iris.....	56
Sound.....	56
HDMI setup.....	57
Expand	58
Language.....	58
Auto setup	59
Keystone.....	59
Logo	64
Security.....	65
Power management.....	67
Filter counter	68
Test pattern	69
Factory default	69
Network	70
Memory Viewer	71
Set slide.....	71
Slide transition effect	71
Sort order	72
Rotate.....	72
Best fit	72
Repeat.....	72
Apply	72
Info.	73
Network control.....	74
Network control operation.....	74
Enter through a web browser.....	76
Useful function	83
Memory Viewer function.....	83
USB display function.....	86

Maintenance and cleaning	88
WARNING light indicator	88
Clean the lens	89
Clean casing of your projector	89
Clear the filter	89
Reset the filter counter	90
Lamp replacement	90
Lamp model	90
Appendix	93
Troubleshooting	93
Menu tree	96
Light indicator status	100
Compatible computer screen	101
Terminal configuration	103
Dimensions	105
Technical Specifications	107
RS232 control mode	110
Getting help	114
Contacting InFocus	114
Restriction of use	116
Network Service	117
Important Statement on Network Service	117
Regional & country specific notices	118
Disposing of your used product In the European Union	118
RF interference (for USA only)	118
Lamps	119
Manufacturer, EU importer and EU Authorised Representative in accordance with EU directives	120
EU Declaration of Conformity	121
UK Declaration of Conformity	125
WARRANTY	129

Safety instructions

This document and your projector employ certain symbols to illustrate how to use your projector safely. They are described below: Please get yourself familiar with them before going through this document.

 Caution	Ignoring messages indicated by this symbol may lead to personal injuries or deaths.
 Note	Ignoring messages indicated by this symbol may lead to personal injuries or property damage.
	High voltage inside with risks of electric shock.
 RG2	RG2.DO NOT stare into the beam.

Please read this manual carefully before installing and operating your projector.

Your projector comes with a number of convenient features and functions. You may make the most of these features and keep your projector in good working conditions by using it correctly. Invalid operation of your projector may not only shorten its life cycle but also may lead to product failure, fire, or other incidents.

In case of any operation abnormality, refer to this manual to check your operation and connections and try solutions given in the “Troubleshooting” section at end of this manual. If the problem persists, call your dealer or our service centres which are listed at the back of this manual.

Your projector's lamp is a consumable and will get dimmer after long-term use. It's normal for an older lamp to be dimmer than a newer one. Please power on and off your projector by strictly following steps given in “Power on your projector” and “Power off your projector” section of this manual. Execute regular maintenance and cleaning according to instructions set forth in “Maintaining and cleaning your projector” section of this manual. Fail to do so may shorten life cycle of your projector and its lamps sharply or even damage your projector and its lamps before long.



Caution

Danger of electric shock
DO NOT open this.



Note: DO NOT remove the casing (or back cover) as this may result in electric shock. Users shall not execute any maintenance work on components within your projector except replacing lamps. Call qualified maintenance personnel in case of any maintenance requirements.



High voltage inside with risks of electric shock.



Operation and maintenance tips about these components.

Chemical Substances table

Component name	Harmful substances					
	Pb	Hg	Cd	Cd(vi)	PBB	PBDE
PCB	x	o	o	o	o	o
Optical components	x	o	o	o	o	o
Projection lens	x	o	o	o	o	o
Projection lamp	x	x	o	o	o	o
Outer casing	x	o	o	o	o	o
Internal mechanical parts	x	o	o	o	o	o
Speaker	x	o	o	o	o	o
Remote control	x	o	o	o	o	o
Annex	x	o	o	o	o	o

This table is made according to SJ/T 11364 specifications.

- o The contents of toxic and hazardous substances in all homogeneous materials of this part is below the limit requirement in GB/T 26572.
- x The contents of toxic and hazardous substances in at least one of the homogeneous materials of this part is above the limit requirement in GB/T 26572 .



The date of products compatible with the projection lamp within the environmental protection period is five years

Safety precautions:



- GROUND your projector.
- The lens of your projector projects strong light. DO NOT look at the light beam directly. You may hurt your eyesight. This is especially the case with children.
- Unplug the AC power plug if your projector will not be used for long time.
- DO NOT overload the socket of power cord as it may lead to fire or electric shock. DO NOT place objects on the projector or its power cord or place the project where the power cord may be tripped over.
- Disconnect the power plug before cleaning your projector. DO NOT apply liquid or sprays to your projector. DO NOT wipe your projector with wet cloth.
- Please follow warnings and instructions given in labels attached to your projector. Unplug your projector when experiencing a thunderstorm weather, is unmanned, or not in use for long periods to prevent damage caused by lightning and power surges.
- DO NOT use accessories without recommendation by the manufacturer as it may result in potential risks.

Precautions on air outlet:



- Keep adequate clearance around your projector for its ventilation and cooling. See figure below for the least clearance requirements. The least clearance is a MUST when your projector is placed within a cabinet or other closed environment.

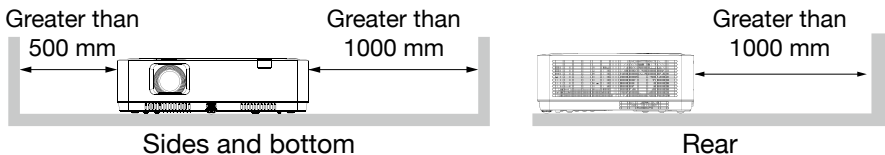

- DO NOT cover the air outlet of your projector. Poor ventilation not only shortens life cycle of your projector but also may lead to risks.
- Slots and openings at rear and bottom of your projector are designed for ventilation and to stop your projector from overheating and to ensure its steady operation.
- DO NOT cover the air outlet with cloth or other objects. DO NOT place your projector on the surface of bed, sofa, carpets, or similar object as this may block the air outlets at its bottom.
- DO NOT place your projector in closed environment, e.g. a bookcase, unless it is well ventilated.
- Keep any matter from falling into your projector through the air outlets as they may touch high voltage parts and lead to fire or electric shock by short circuits. DO NOT splash liquid to your projector.

Precautions on location of your projector:



- Place your projector in a proper location or it may result in fire.
- DO NOT expose your projector in rain or high humidity environments or it may result in fire or electric shock. DO NOT your projector near water or splashing water. DO NOT place any water container, e.g. flower vase, atop your projector.
- DO NOT place your projector in environments of soot, moisture or smoke, e.g. your kitchen, or it may lead to product failure or accidents. Your projector may be damaged by contact with oil or chemicals.
- DO NOT place your projector near exhaust pipe or air conditioning equipment.
- DO NOT place your projector near radiator or heating pipes.
- DO NOT place your projector on a unstable truck, rack, or table. It may fall and/or lead to personal injuries and property damages. Please use cart or rack recommended by the manufacturer or included with your product. Please follow steps given in the installation guidelines included with the wall or ceiling mount. Use installation components approved by the manufacturer.
- Be careful when moving your projector when mounted on a cart. Abrupt stops, pushing too hard and rugged surfaces may topple your projector as well as the cart.

FOR EU USERS

The symbol mark and recycling systems described below apply to EU countries and do not apply to countries in other areas of the world.

Your product is designed and manufactured with high quality materials and components which can be recycled and, or reused.



The symbol mark means that electrical and electronic equipment, batteries and accumulators, at their end-of-life, should be disposed of separately from your household waste.



Note

If a chemical symbol is printed beneath the symbol mark, this chemical symbol means that the battery or accumulator contains a heavy metal at a certain concentration.

This will be indicated as follows: Hg: mercury, Cd: cadmium, Pb: lead In the European Union there are separate collection systems for used electrical and electronic equipment, batteries and accumulators.

Please, dispose of them correctly at your local community waste collection, recycling centre.

Please help us to conserve the environment we live in!

Contains mercury



Caution

For more information on safe handling procedures, the measures to be taken in case of accidental breakage and safe disposal options visit: ec.gc.ca/mercure-mercury/.

Dispose of or recycle in accordance with applicable laws.

Precautions on using your projector:



Note

- DO NOT project the same image for long time as residual images may be long periods of displayed. This effect is called ghosting and is inherent to LCD display technology.
- Use power as indicated in tags attached to your projector. If you have doubts over available power type, consult your dealer or local power company first.
- DO NOT open or remove the casing as this may lead to electric shock or other damages. Call qualified maintenance personnel or InFocus customer service case of any maintenance requirements.
- In case of the following, unplug the power cord and call qualified maintenance personnel for service immediately:
 - a. Damaged or broken power cord or plug
 - b. Liquid splashed in your projector
 - c. Your projector exposed to rain or water
 - d. If your projector fails to work as expected by following operation instructions, adjust it according to given instructions. Other invalid operations may damage your projector, which requires the technician to spend more time before returning it back to normal.
 - e. The projector falls or its casing is damaged.
 - f. In case of any abnormal change in your projector during its use, then maintenance services would be required.
- In case components replacement is required, ensure to use a InFocus authorised service centre. Use of unauthorized parts may lead to fire, electric shock or personal injury.
- After the completion of maintenance or repair work, get the maintenance personnel to run routine safety check to ensure your projector's safety operation status.

Information for users in the European Union

This is a device to project images onto a screen, etc., and is not intended for use as indoor lighting in a domestic environment. Directive 2009, 125, EC.

NOTE FOR CUSTOMERS IN THE US

(Hg) LAMP(S) INSIDE THIS PRODUCT CONTAIN MERCURY AND MUST BE RECYCLED OR DISPOSED OF ACCORDING TO LOCAL STATE OR FEDERAL LAWS.

Air ventilation

Openings in the casing are designed for ventilation and overheating prevention. DO NOT block or cover these openings to keep your projector in normal operation and from overheating.



Note

Heat exhaust at the air outlet.
Keep the following in mind when using or installing your projector:

- DO NOT place flammable materials or sprayers near your projector.
- Keep the air outlet one meter away from other objects.
- DO NOT touch the area close to the air outlet especially the metal components, e.g. screws. This area and parts will get very hot once your projector starts operating.
- DO NOT place any object on top your projector. They may not only be damaged but also lead to fire after being overheated.

Cooling fans are designed for cooling your projector. Fan speed is auto adjusted subject to internal temperature of your projector.

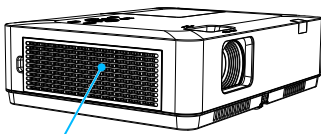

Air outlet (For heat exhaust)

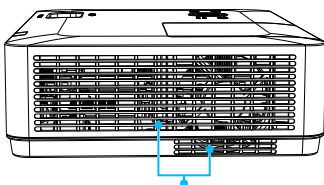

Air intake

Place your projector correctly

Use your projector at specified location in correct way. Invalid projector location may shorten life-cycle of lamps or even lead to severe incidents or fire.



Note

Avoid installing your projector as illustrated below:

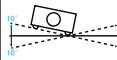

DO NOT tilt your projector more than 10 degrees.

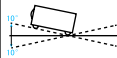

DO NOT tilt your projector more than 10 degrees.



DO NOT put the projector on a vertical projection.



DO NOT put the projector upside down to make a projection.



DO NOT put the projector on either side to project an image.



Note

Precautions on ceiling mount installation:

- Get qualified technician to install the ceiling mount racket.
- Warranty of your projector does not cover hazards and damage caused by using or incorrectly installed ceiling mount.

Moving your projector

When moving your projector close its adjustment legs as they may damage the lens and casing. Keep your projector in suitable box when it is not to be used for a long time.



Note

Precautions on moving or shipping your projector:

- DO NOT drop your projector as it may get damaged or failed in operation.
- Focus.
- Prohibit express or other shipping service provider personnel from shipping your projector with improper boxes. Your projector may become damaged. Please consult your dealers for shipping your projector by express or other shipping service providers.
- Place your projector in box only after it has fully cooled down.

Precautions on dealing with your projector:

DO NOT lift or move your projector by holding the lens, zoom or focus ring as it may damage the lens and your projector.

Be careful when handling your projector. DO NOT drop it, subject it to external forces, or place objects atop it.



Note



The projection lens is manually adjusted from the top of the projector.

Precautions on using your projector:



- DO NOT touch the lens when it is working as your fingers may get hurt.
- DO NOT let children touch the lens.

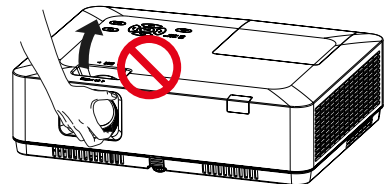
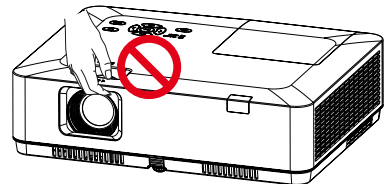
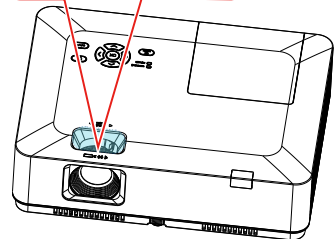
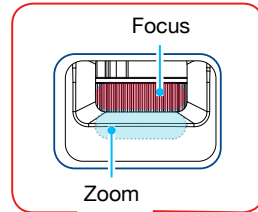

DO NOT hold the lens or area around it.

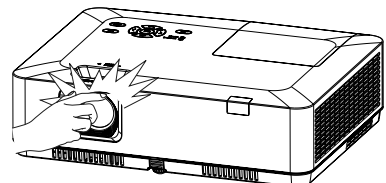

FCC



Note

This equipment has been tested and found to comply with the limits for a Class B digital device, pursuant to Part 15 of the FCC Rules. These limits are designed to provide reasonable protection against harmful interference in a residential installation. This equipment generates, uses, and can radiate radio frequency energy, and if not installed and used in accordance with the instructions, may cause harmful interference to radio communications. However, there is no guarantee that interference will not occur in a particular installation. If this equipment does cause harmful interference to radio or television reception, which can be determined by turning the equipment off and on, the user is encouraged to try to correct the interference by one or more of the following measures:



- Reorient or relocate the receiving antenna.
- Increase the separation between the equipment and receiver.
- Connect the equipment into an outlet on a circuit different from that to which the receiver is connected.
- Consult the dealer or an experienced radio, TV technician for help.

Use of shielded cable is required to comply with class B limits in Subpart B of Part 15 of FCC Rules.

Do not make any changes or modifications to the equipment unless otherwise specified in the instructions. If such changes or modifications should be made, you could be required to stop operation of the equipment.

Accessory

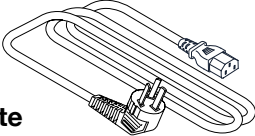
Included accessories are as follows:

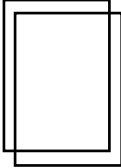
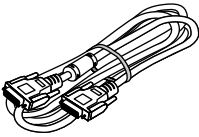
<p>AC power cord</p>	<p>Remote control without batteries</p>
<p> Note A regional specific AC power cord is provided with your projector.</p> 	
<p>Quick start guide</p>	<p>VGA cable</p>
	

Name and function of your projector

Front/Top

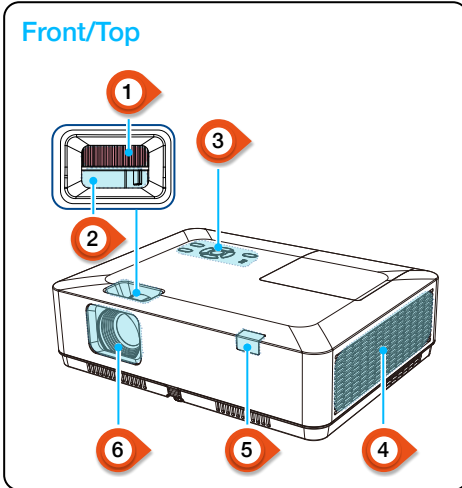

- 1 Zoom ring
- 2 Focus ring
- 3 Keypad control panel
- 4 Filter
- 5 IR receiver (front)
- 6 Projection lens
- 7 Speaker
- 8 Anti-theft lock slot
- 9 AC Power Cord port
- 10 IR receiver (back)
- 11 Kensington security slot

Rear

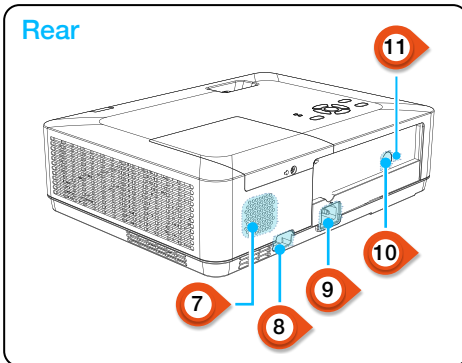

- 7 Speaker
- 8 Anti-theft lock slot
- 9 AC Power Cord port
- 10 IR receiver (back)
- 11 Kensington security slot

Note

- Kensington security slot is for a Kensington lock used to deter theft of the projector.
- Kensington is a registered trademark of ACCO Brands Corporation.

Bottom

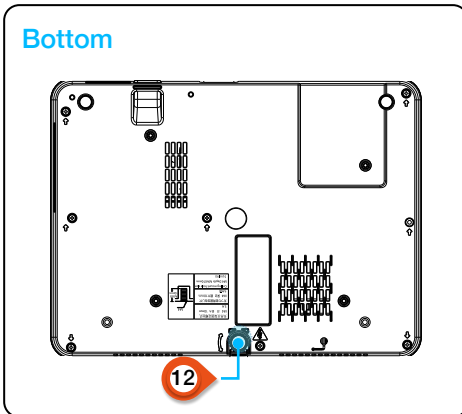

- 12 Adjustable front foot

Note

Do not place your hands or other objects near the vent:

- Vent will shed heat. Do not put your hands or face, or thermolabile objects placed near the outlet. You need keep at least a distance of 3' (1m) away, or it may cause it burning or damage.

Name and function of your projector

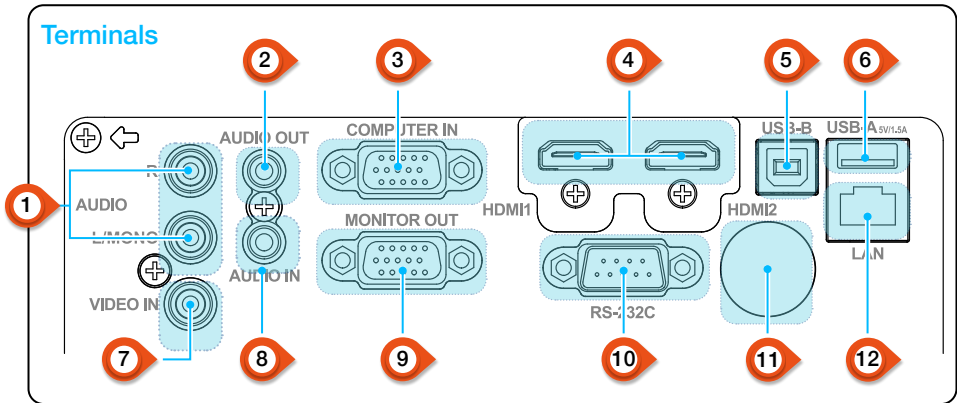

1 Mono (L/R) terminal

A Mono audio signal (A single audio terminal) should be connected to the AUDIO (R / L) interface.

2 AUDIO OUT terminal

Connect external audio devices to this terminal.

3 COMPUTER IN

Connect RGB to this terminal.

4 HDMI1, HDMI2 connector

Connect HDMI1 digital output signals or HDMI2 digital output signals to these terminals.

5 USB-B connector

When using the "USB display" function, connect your computer to this terminal via the USB cable.

6 USB-A connector

When using the Memory Viewer function, insert the USB stick or HDD directly to this terminal.

7 VIDEO IN terminal

Connect video output signal to this terminal.

8 AUDIO IN terminal

Connect audio signal of the PC to this terminal.

9 MONITOR OUT terminal

For monitor output, output the signal from to other monitors.

10 RS-232C

When using the RS232 functional to operate the projector, connect the serial communication to this terminal.

11 IR (rear)

Receives the remote control IR signal.

12 LAN terminal

Connect a RJ45 cable to this terminal when using network control to operate your projector.

- For IN1029, IN1039, IN1049, IN1059, IN1024, IN1034, IN1044, IN1026, IN1036, IN1046

Name and function of your projector

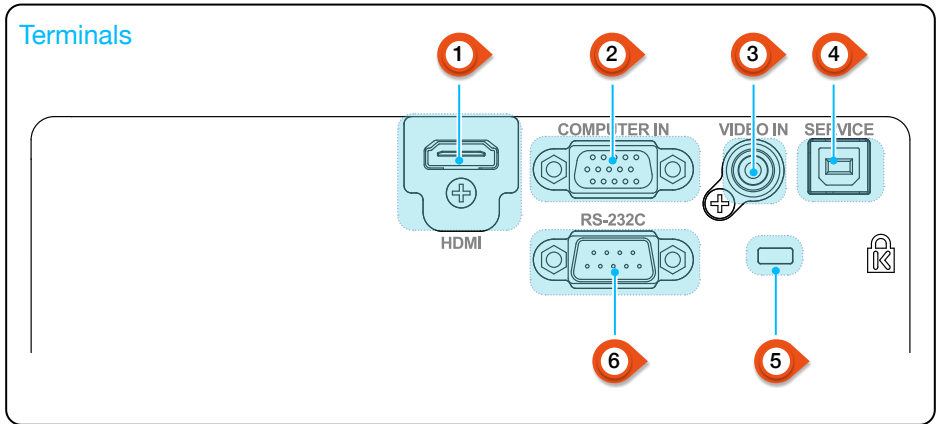

1 HDMI connector

Connect HDMI digital output signals to this terminal.

2 COMPUTER IN

Connect RGB to this terminal.

3 VIDEO IN terminal

Connect video output signal to this terminal.

4 SERVICE terminal

Upgrade features only.

5 Kensington security slot

When using the "Kensington security slot" function, it will help users to deter theft of the projector.

6 RS-232C

When using the RS232 functional to operate the projector, connect the serial communication to this terminal.

- For IN1004, IN1014

Name and function of your projector

Keypad controls and indicator lights

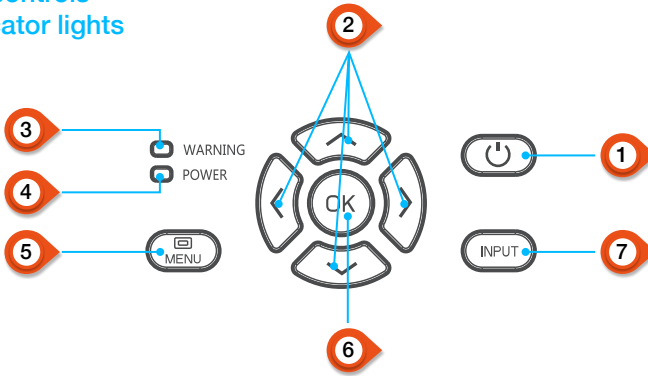

1 POWER

Turn on or off the projector.

2 Arrow ▲▼◀▶ /UP/DOWN/VOL-/VOL+/ 6 OK

- Select items or adjust the data in the OSD menu.
- Shift the image in the "Digital zoom +/-" mode.
- Adjust the volume.

5 MENU

Open or close the OSD menu.

7 INPUT

7 INPUT

Open or close the INPUT menu.

3 WARNING indicator

- The indicator is flashing red, when the internal temperature of the projector exceeds the operating range.

4 POWER indicator

- The power indicator turns steady red, when the projector is in standby mode.
- The power indicator turns steady green, during normal projector operation.
- The power indicator is flashing green, when the projector is in power management mode.
- The power indicator is flashing red, when the projector is in cooling mode.
- The power indicator turns steady green yellow, when the projector power is abnormal.

Name and function of your projector

1 POWER

Power on or off your projector.

2 INPUT

Open or close the INPUT menu.

3 VGA

Select VGA input source.

4 AUTO

Enter auto adjustment mode.

5 VIDEO

Select VIDEO input source.

6 HDMI

Select HDMI 1, HDMI 2 input source.

7 MENU

Open or close the OSD menu.

8 Arrow ▲▼◀▶

- Select items or adjust data in the OSD menu.
- Select display area in digital zoom+/- mode.

9 OK

Enter the OSD menu or select options in it.

10 IMAGE

Select image mode.

11 KEystone

Keystone calibration.

12 SCREEN

Enter the screen size adjustment menu.

13 LAMP

Select lamp mode.

Remote control

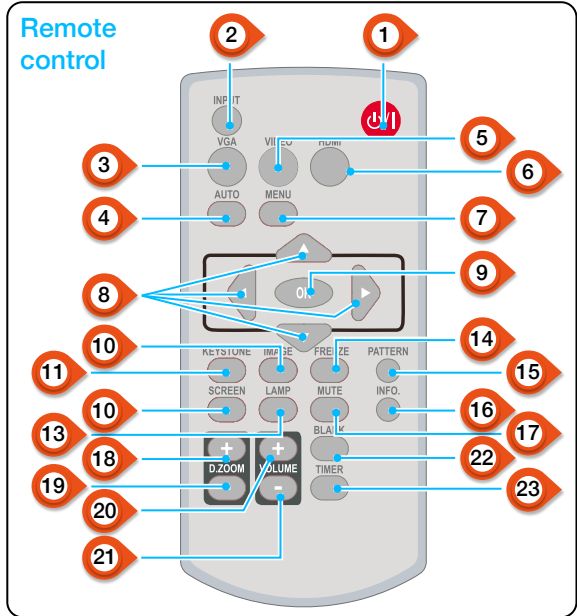

14 FREEZE

Freeze projected images.

15 PATTERN

Select built-in test pattern of your projector.

16 INFO

Display current status info of your projector.

17 MUTE

Turn off the sound Temporarily.

18 D.ZOOM +

Zoom in projected image.

19 D.ZOOM -

Zoom out projected image.

20 VOLUME +

Increase volume.

21 VOLUME -

Decrease volume.

22 BLANK

Make the screen blank temporarily.

23 TIMER



Enable the timer function.



PATTERN button on the remote control is invalid when you choose USB display, memory viewer or network as input signal.

Name and function of your projector

Installing batteries in the remote control

<p>1 Open the battery cover.</p> 	<p>2 Insert new AAA batteries.</p> <p>Two AAA batteries</p> <p>Place batteries with its anode and cathode (+ and -) in correct direction. Keep both poles in good connection to the contacts within the compartment.</p> 	<p>3 Put the cover back.</p> 
---	---	--



Please follow the following rules for safety operation:

- Use two of AAA batteries of the same brand.
- Replace both batteries at the same time.
- Do not mix new and old batteries as one pair.
- Keep your remote control away from water or other liquids.
- Do not expose your remote control to environments with high humidity or temperature.
- Do not drop your remote control.
- In case of any battery solution leaking in the compartment, clear it thoroughly before placing new batteries in it.
- Using battery of other types than what specified on this manual may lead to risks of explosion.
- Please dispose your old battery by following instructions given in tag of the battery or local regulations.

Remote control operation range

Point your remote control to the IR receiver of your projector.

Maximum operation range of your remote control is +/- 30° and with a radius 6 meters or +/- 8 meters in straight line.

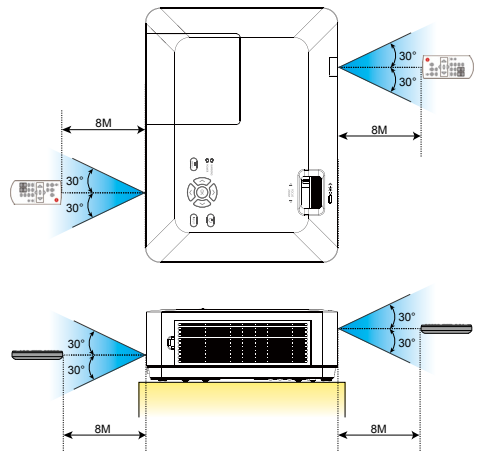

Set up your projector

Ambient brightness may affect your projection image quality. For the optimal image, it is recommended to control the brightness in your environment.

Values shown in figure below are approximates only. They may differ from the actual ones.

The further the projector is away from the screen, the larger the projection size will be.

Use the following table to install the projector in the best position from the screen. The values provided are for reference only.

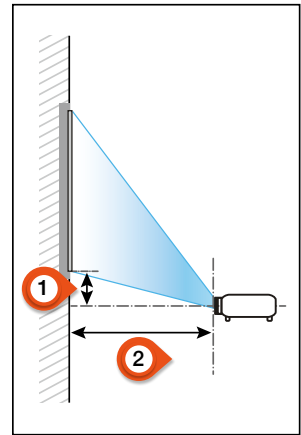
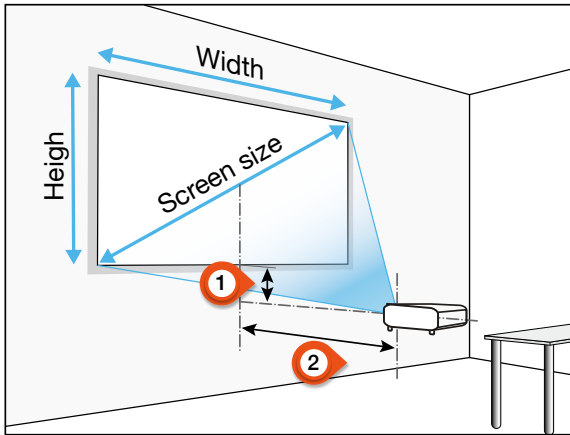

1 Projection distance

The value indicates the distance from the screen to the front edge of the projector.

2 Lens offset

The value indicates the distance from the optical axis of the projection lens to the lower edge of the projected area.

*The results are the values calculated by standard designed specifications, however, they don't provide any guarantees.

IN1004, IN1014

Screen size			Projection distance			
			Standard 4:3		Compatible 16:9	
Screen size (inch)	Width (m)	Height (m)	Wide	Tele	Wide	Tele
30"	0.610	0.457	0.887	1.069	0.968	1.167
60"	1.219	0.914	1.797	2.161	1.960	2.356
80"	1.626	1.219	2.404	2.889	2.621	3.149
100"	2.032	1.524	3.010	3.617	3.282	3.943
150"	3.048	2.286	4.527	5.438	4.934	5.926
200"	4.064	3.048	6.044	7.258	6.587	7.909
250"	5.080	3.810	7.559	9.078	8.239	9.892
300"	6.096	4.572	9.077	10.899	9.892	11.874

IN1024, IN1034, IN1044

Screen size			Projection distance			
			Standard 4:3		Compatible 16:9	
Screen size (inch)	Width (m)	Height (m)	Wide	Tele	Wide	Tele
30"	0.610	0.457	0.812	1.347	0.885	1.467
60"	1.219	0.914	1.630	2.702	1.776	2.944
80"	1.626	1.219	2.178	3.610	2.373	3.933
100"	2.032	1.524	2.728	4.523	2.972	4.927
150"	3.048	2.286	4.114	6.820	4.482	7.430
200"	4.064	3.048	5.514	9.141	6.008	9.959
250"	5.080	3.810	6.929	11.486	7.549	12.513
300"	6.096	4.572	8.358	13.855	9.106	15.094

IN1026

Screen size			Projection distance			
			Standard 16:10		Compatible 16:9	
Screen size (inch)	Width (m)	Height (m)	Wide	Tele	Wide	Tele
30"	0.646	0.404	0.942	1.137	0.969	1.169
60"	1.292	0.808	1.910	2.299	1.963	2.363
80"	1.723	1.077	2.554	3.073	2.626	3.159
100"	2.154	1.346	3.199	3.848	3.289	3.956
150"	3.231	2.019	4.811	5.785	4.946	5.946
200"	4.308	2.692	6.423	7.721	6.602	7.937
250"	5.385	3.365	8.035	9.658	8.259	9.927
300"	6.462	4.039	9.647	11.595	9.916	11.917

IN1046, IN1039, IN1059

Screen size			Projection distance			
			Standard 16:10		Compatible 16:9	
Screen size (inch)	Width (m)	Height (m)	Wide	Tele	Wide	Tele
30"	0.646	0.404	0.812	1.347	0.835	1.384
60"	1.292	0.808	1.630	2.702	1.675	2.777
80"	1.723	1.077	2.178	3.610	2.239	3.711
100"	2.154	1.346	2.728	4.523	2.804	4.648
150"	3.231	2.019	4.114	6.820	4.228	7.009
200"	4.308	2.692	5.520	9.150	5.673	9.405
250"	5.385	3.365	6.936	11.498	7.129	11.817
300"	6.462	4.039	8.367	13.869	8.599	14.255

IN1036, IN1029, IN1049

Screen size			Projection distance			
			Standard 16:10		Compatible 16:9	
Screen size (inch)	Width (m)	Height (m)	Wide	Tele	Wide	Tele
30"	0.646	0.404	0.872	1.053	0.896	1.082
60"	1.292	0.808	1.769	2.129	1.818	2.188
80"	1.723	1.077	2.365	2.845	2.431	2.924
100"	2.154	1.346	2.962	3.563	3.044	3.662
150"	3.231	2.019	4.455	5.356	4.578	5.505
200"	4.308	2.692	5.947	7.149	6.113	7.348
250"	5.385	3.365	7.440	8.943	7.647	9.191
300"	6.462	4.039	8.932	10.736	9.181	11.035

Adjust the projected image

Adjust the position of the projected image:

1. Place the projector so that it is perpendicular to the screen, Image (1).
2. Raise the front of the projector and press the foot lock on the projector. Loosen the foot lock can lock the adjustable foot. Rotate the adjustable foot to adjust the height.

Rotating the adjustable foot in the direction shown in the Image (2) to extend it, and rotating in the opposite direction retracts it, thus adjusting the vertical projection angle.

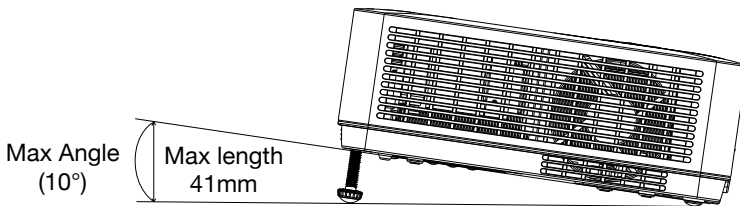

Adjustable feet lock

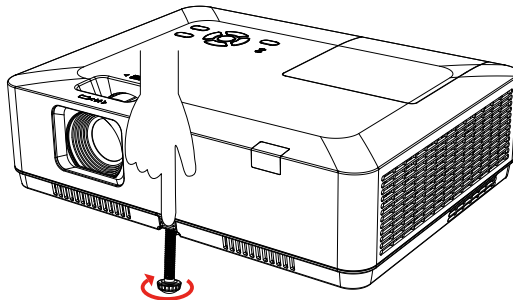
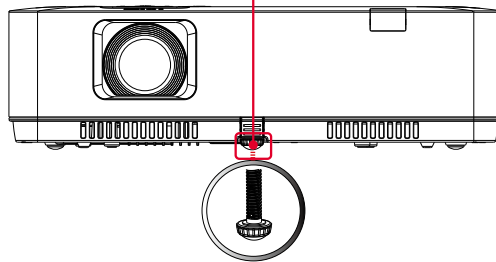

Connect to PC (digital and analogue RGB)

Cables for connection:

- VGA cable
- HDMI cable*
- Crossover serial cable*

* This cable is not included with the projector

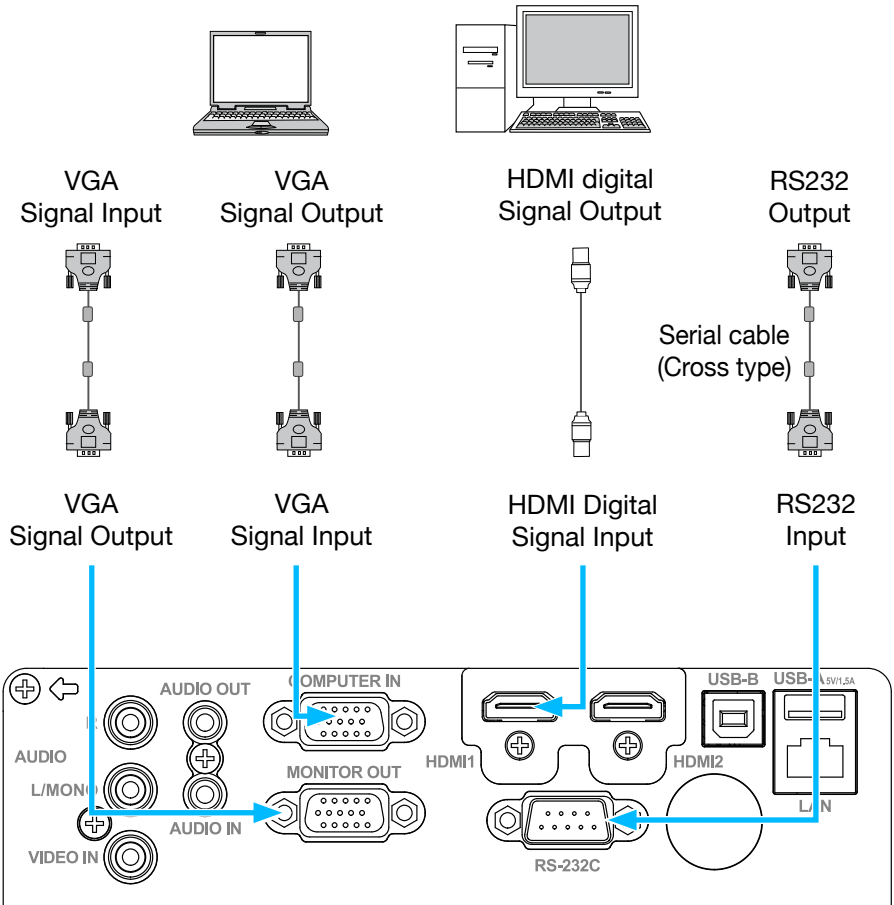

- For IN1029, IN1039, IN1049, IN1059, IN1024, IN1034, IN1044, IN1026, IN1036, IN1046

Connect to video equipment

Cables for connection:

- VIDEO cable*

* This cable is not included

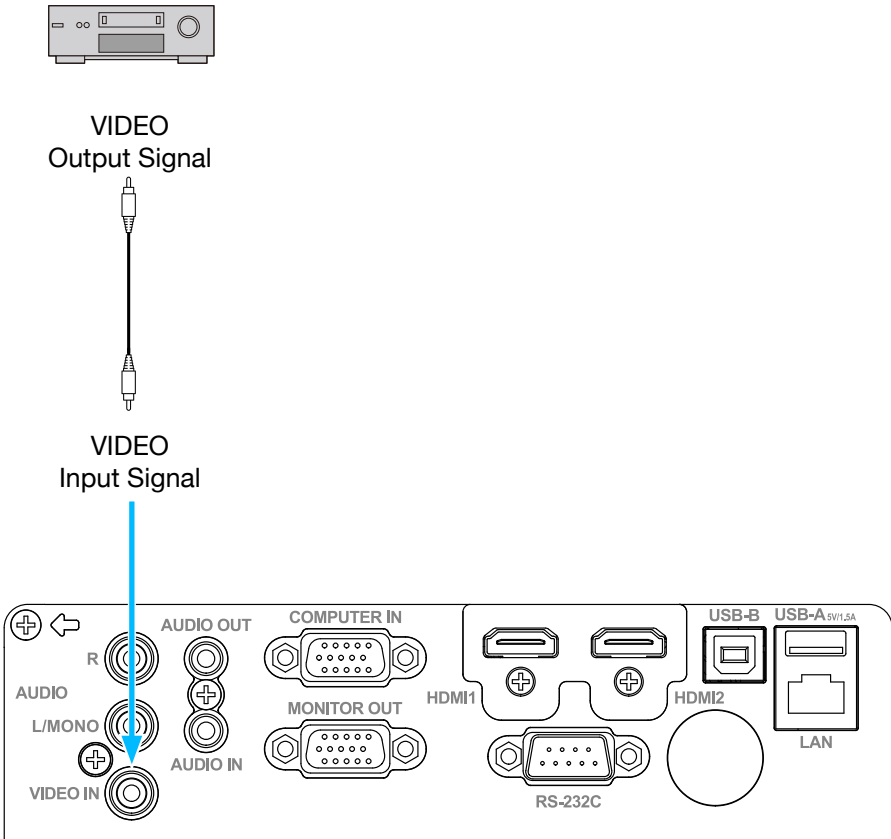

- For IN1029, IN1039, IN1049, IN1059, IN1024, IN1034, IN1044, IN1026, IN1036, IN1046

Connect to audio equipment

Cables for connection:

- Audio cable*

* This cable is not included

External audio devices

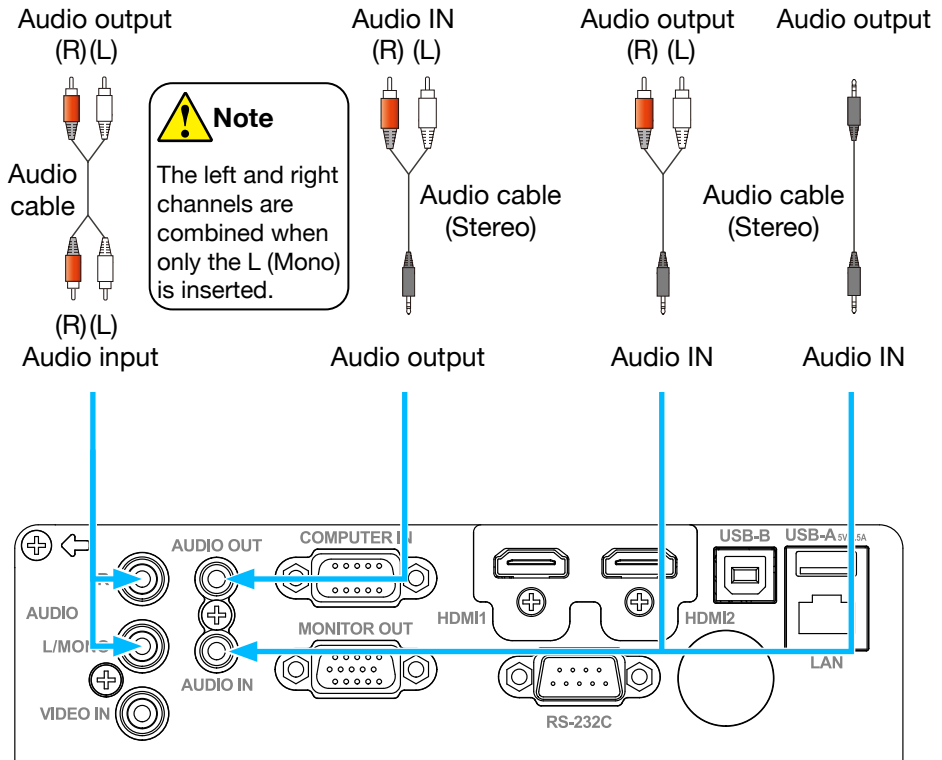
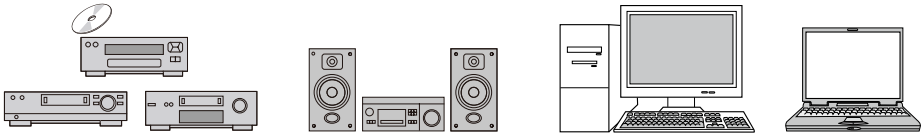

- For IN1029, IN1039, IN1049, IN1059, IN1024, IN1034, IN1044, IN1026, IN1036, IN1046

Connect to USB (USB-A – USB-B or USB-C – USB-B)

Cables for connection:

- USB-A to USB-B cable*
- USB-C to USB-B cable*

* This cable is not included

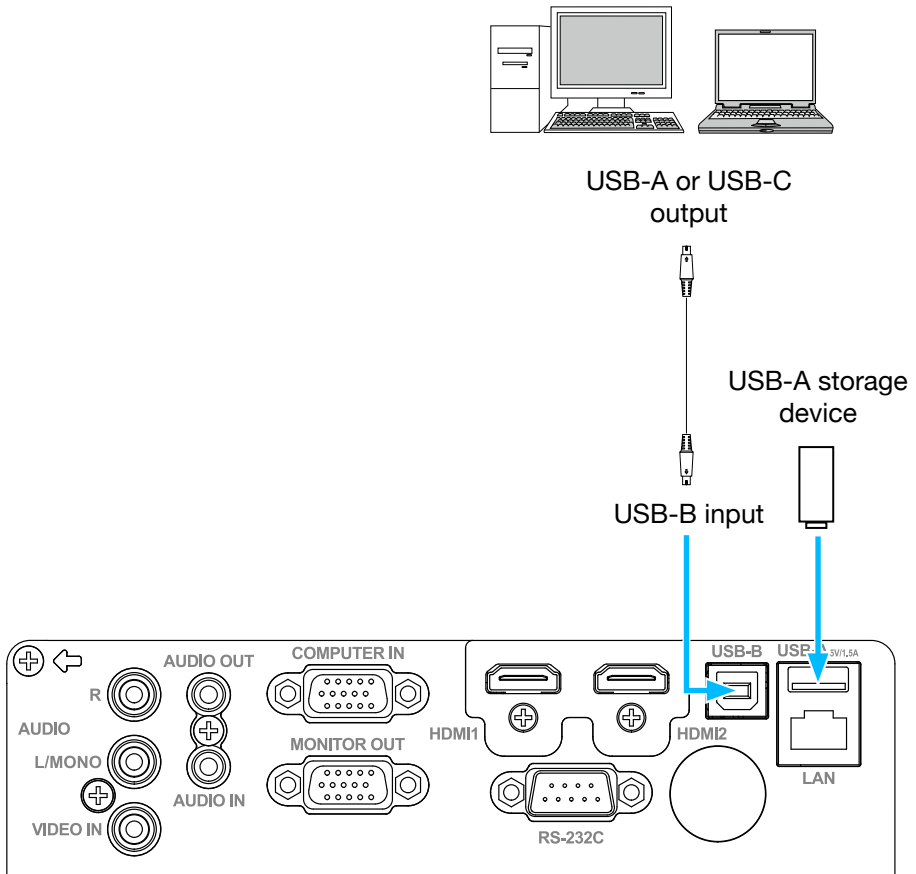

- For IN1029, IN1039, IN1049, IN1059, IN1024, IN1034, IN1044, IN1026, IN1036, IN1046

Connect to PC (Digital and Analogue RGB)

Cables for connection:

- VGA cable
- HDMI cable*
- Crossover serial cable*

* This cable is not included

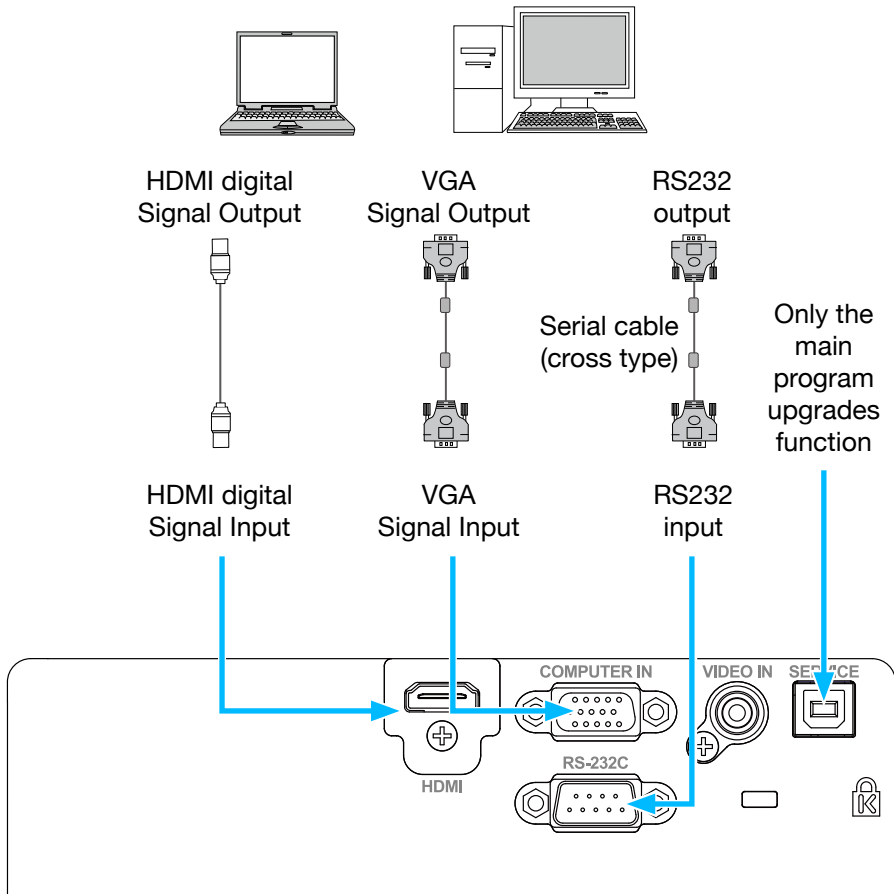

- For IN1004, IN1014

Connect to video equipment

Cables for connection:

- VIDEO cable*

* This cable is not included

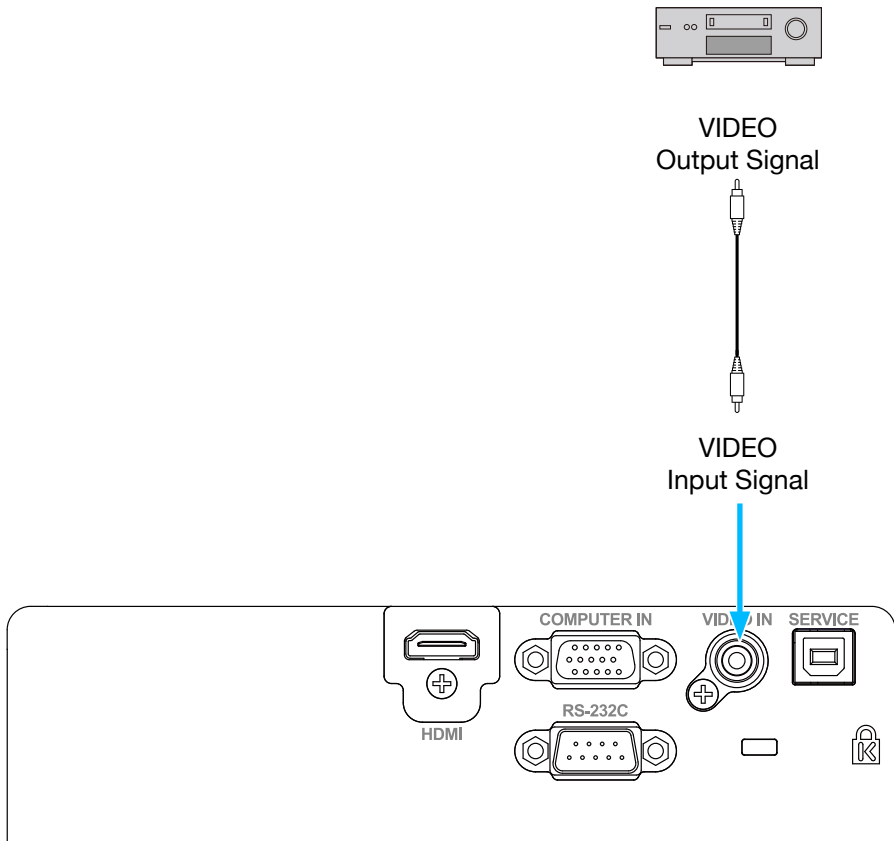

- For IN1004, IN1014

Connect the AC power cord

The required standard voltage of your projector is AC 100-240V. It adapts to different input voltage automatically. Your projector uses a single-phase power cord with neutral ground cabling.

Do not use any other type of power cords or you may face the risks of electric shock. In case you have any doubt on the type of power cord you are using, please call your dealer or service centre for help. Before powering on your projector, get all external equipment connected in advance.



Note

Keep your AC power socket close to your projector for easy plugging and unplugging.



Note

For safety reasons, unplug the AC power cord when your projector is not in use. Your projector will consume a small amount of power when it is connected to AC power grid and in standby mode.

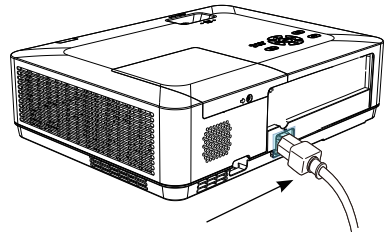

Connect included AC power cord to your projector.

Precautions on power cord

Your AC power cord should meet regulations of the country, district where your projector is used.

Please make sure the type of the power plug is compliant with those given in figure below. Make sure you are using a valid AC power cord.

In case the included AC power cord does not comply with the AC power socket in your location, call your dealer for a replacement.

The projector side

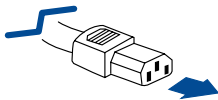

Connect to power cord connector of your projector

Connect to the AC power socket

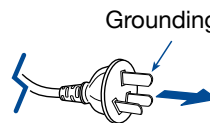

Connect to AC power socket



Note

- Use of invalid power cord may hamper product performance or even lead to electric shock, fire, and other incidents. Always use a compliant power cord ensure product performance and operation safety.
- The frequently used cables are: AC power cord, VGA cable, audio cable, video cable, and serial control cable.

Power on your projector

1. Connect all external equipment to your projector (e.g. computer or camera) before powering it on.
2. Connect AC power cord of your projector to an AC power socket. The Power indicator turns on in red.
3. Press the Power button on the top control panel or the remote control. The Power indicator lights in green and the cooling fan starts running.
4. If your projector is set up as password protected, the password dialogue box displays. Enter your password as instructed below.

Enter password (PIN)

Press ▲▼ button to select a number, press ► button to enter it and move the cursor. The number you typed is displayed as “*”. To edit number you have entered, press ◀ button to move the cursor to the number you want to change, press ▲▼ button to select the correct one.

Repeat this step to type in a 3-digit number.

Move the cursor to set after you have typed the 3-digit number. Press the <OK> button and now you are ready to use your projector.

If the password is invalid, the password displayed as “***” will be in red. Please try again with a valid one.

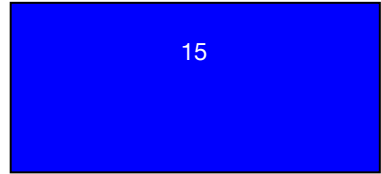

Note

In case the “Logo Select” option is set to OFF, then no welcome image will display on screen.

You can do nothing but powering off your projector during the period welcome image is displayed.

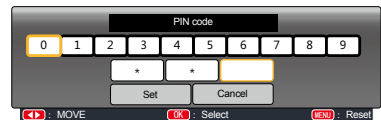
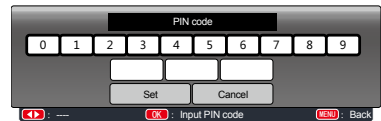

Move the cursor to Set button, then press the <OK> button.

What is a password (PIN)?

A Personal Identification Number (PIN) is an ID code used for security purposes and to allow authorised used of the projector. A password (PIN) setting may help preventing your projector from unauthorized use.

Your password (PIN) code is a 3-digit number. To find out more about protecting your projector with a password (PIN), please refer to the PIN Code Lock function in the Setting menu for details.

Precautions on password (PIN) operation:

You cannot operate a password (PIN) protected projector without correct password (PIN). Please set up a new password (PIN) and keep your operation manual in safe place. In case the password (PIN) is lost or forgotten, call your dealer or service centre.

Power off your projector

1. Press the Power button at the top control panel or the remote control, the “Power off?” message displays.
2. Press the Power button again in 4 seconds after the “Power off?” message prompted to you. The POWER indicator flashes red while the cooling fan continues running. (You may set up noise level and speed of the fan.) Unplug the power cord until the fan stops running. Failure to do so may shorten life cycle of your projector or lead to power on failures or operation abnormalities.
3. The POWER indicator stops flashing once the projector has been cooled down to ready for power on again.

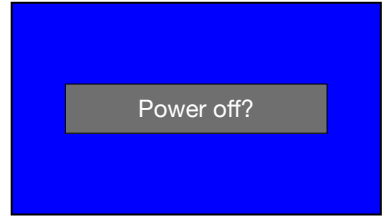

“Power off?” message disappears in 4 seconds.



To maintain the life cycle of the lamp, only power off your projector after it has been turned on for at least five minutes.

Do not leave your projector turned on for extended periods of time. As it may hurt the life cycle of your lamp. Power off your projector at least once every 24 hours and have it idle for an hour.



Note

- If the “Direct power on” function is set to “On”, your projector will power on once it is connected to an AC power socket.
- Speed of the cooling fan speed varies based on the internal temperature of your projector.
- Do not place your projector in any box before it is fully cooled down.
- In case the POWER indicator flashes or turns red, refer to the “WARNING light indicator” for instructions.
- The POWER indicator flashes when the lamp is cooling down. Do not power on your projector at this time. Power on your projector only after the POWER indicator turns red.
- Unplug the power cord after your projector has been turned off. The fan stops running.
- The POWER indicator turns red when your projector is ready for power on again. It takes less time to restart your projector after it was powered off in the standard power off procedure than that of the non-standard one.

Basic operation

How to operate the OSD

You can adjust or set up the projector via the on-screen menu.

The menu has a multilayer structure. each main menu is divided into several sub-level menus, with further levels below each sub-level.

Please refer to the appropriate section of this manual for the procedure on adjustment and settings. Press the MENU button on the projector keypad or remote control and the OSD displays.

1. Press the MENU button on the projector keypad or remote control and the OSD displays.
2. Press ▲▼ button to act on or select one main menu item. Press ► button or <OK> button to enter a submenu.
3. Press ▲▼ button to select required submenu, then press <OK> button or ► button to set up or enter an option.
4. Press ▲▼ button to select settings or navigate options, then press <OK> button to act on the item and exit.
5. Press ◀ button to return to main menu. Press the MENU button on remote control or control panel to exit the OSD.

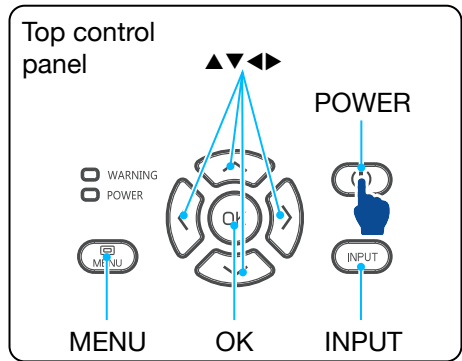
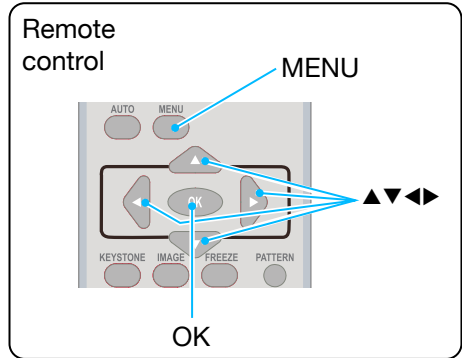

OSD Menu

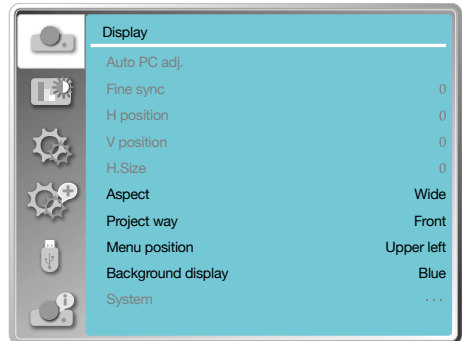

Menu item overview

1 Display menu

- Select Auto PC adj., Fine sync, H position, V position, H.Size to adjust the parameters to match the VGA format.
- Aspect: Normal, Wide, Full, Advanced.
- Project way: choose Front, Rear, Ceiling/Front, Ceiling/Rear, Auto ceiling/Front and Auto ceiling/Rear.
- Menu position: Set screen menu display position on the screen.
- Background display: Sets the background colour of the projection screen.
- System: Select the compatible system signal format with input source.

2 Colour adjust menu

Available options in the Image mode menu are Dynamic, Standard, Cinema, Blackboard (Green), Colorboard, User Image.

- For AV signal input, the available colour adjust options: contrast, brightness, colour, tint, white balance (red, green, blue) and sharpness.
- For PC signal input, the available colour adjust options: contrast, brightness, colour temp., white balance (red, green, blue) and sharpness.

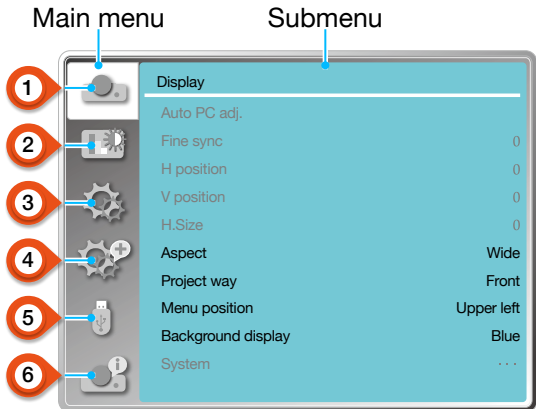

3 Setting menu

Configuration of the basic function operation on the projector: Direct power on, Standby mode, High land (High Altitude), Light source mode, Cooling fast, Closed caption, Key lock, Iris, Sound and HDMI setup.

4 Expand menu

Available adjust options are Language, Auto setup, Keystone, Logo, Security, Power management, Filter counter, Test pattern, Network, Factory default.

5 Memory Viewer menu

Select parameter of Set slide, Slide transition effect, Sort order, Rotate, Best fit, Repeat, Apply.

6 Info. menu

Display information about the projector.

Adjust the Projector Zoom and Focus

1. Rotate the zoom ring from the centre, rotate the picture to the left to zoom out or rotate the picture to the right to zoom in.
2. Rotate the focus ring to adjust the focal length of the image, and adjust it to be clear according to the display content of the screen.

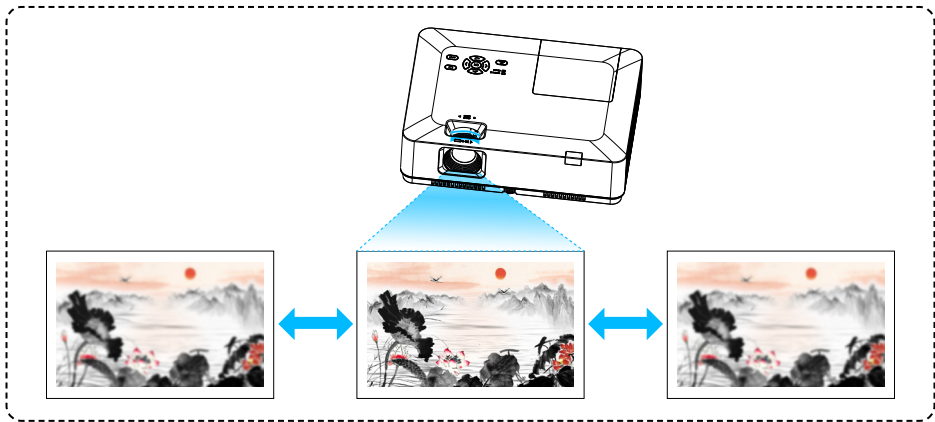
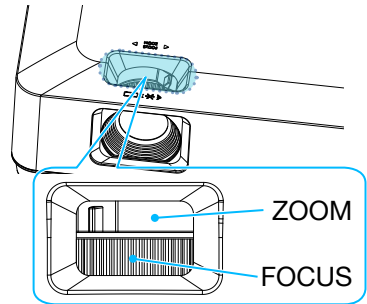

Adjust the projector Focus

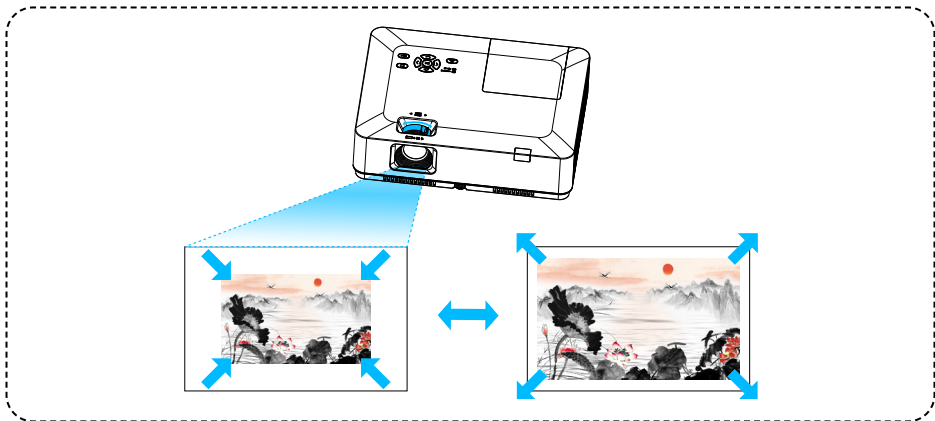

Adjust the projector Zoom

Basic operation

Auto setting function

Press the AUTO button on your remote control to auto execute settings given in the Auto Setup on the Expand menu (including Input search, Auto PC adj. and Auto keystone).

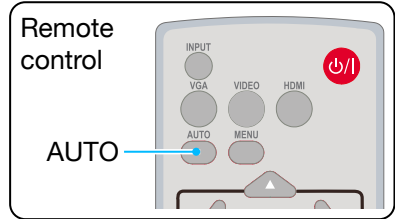

Keystone adjustment

You may adjust keystone distortion of image in your projector with the H/V keystone adjustment. Follow steps below to adjust keystone distortion of projected image manually.

Press the KEYSTONE button on your remote control. The keystone adjustment dialogue box displays (including H/V keystone, corner correction, curved correction, reset value), press ▲▼◀▶ button to adjust keystone distortion.

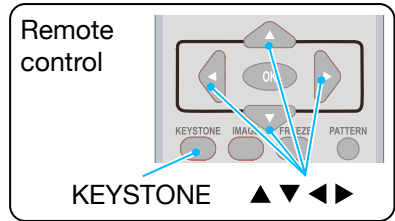

H/V Keystone Adjust the projected image when the projector is on the horizontal or vertical keystone distortion.

Corner correction Adjust the projected image when the projector is keystone distortion of four corners.

Curved correction Adjust the projected image when the projector linearity is uneven or the projected images bent vertically and horizontally.

Reset value The correction values will be restored to the factory defaults.

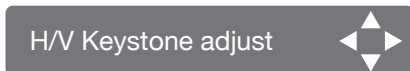

- The arrow mark looks white when there is no keystone adjustment in existence.
- The arrow mark indicating the adjustment direction turns red.
- The arrow mark disappears when the maximum adjustment limit reaches.

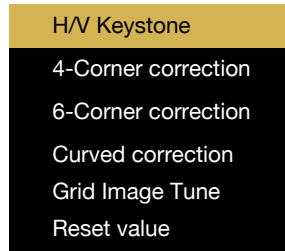

- For WUXGA resolution

- The keystone prompt box will disappear if you press the keystone button again when it is displaying. Press the <OK> button again to switch the four correction items.
- The adjustable range is subject to source of signal input.

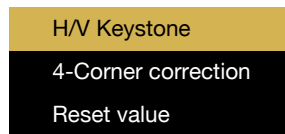

- For XGA&WXGA resolution

Basic operation

Volume adjustment

For quick adjustment of the volume settings please use the remote control.

Volume

Press the remote control Volume +/- buttons to adjust the volume.

MUTE

Press the mute button on the remote control to select "ON", you can temporarily turn off the sound. Press the mute button again to select "Off" or press the Volume +/- keys to re-open the audio effects.

Mute function is also effective for audio output interfaces.

Menu operation

1. Press the MENU button on the top control panel or remote control and the OSD displays. Press ▲▼ button to enter setting menu, then press <OK> or ► button.
2. Press ▲▼ button to select sound, press <OK> or ► button to enter.
3. Press ▲▼ button to select volume or mute.

Volume

Press ▲ button to increase volume.
Press ▼ button to decrease volume.

Mute

Press ▲▼ button to switch to On or Off.

4. Press <OK> button to select.

Remote control

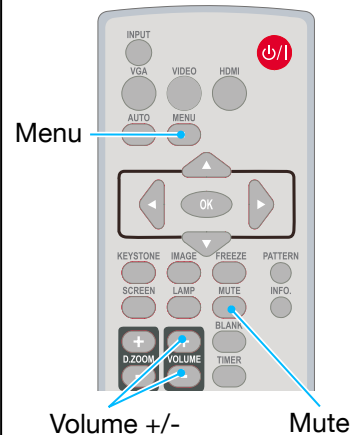

Sound menu

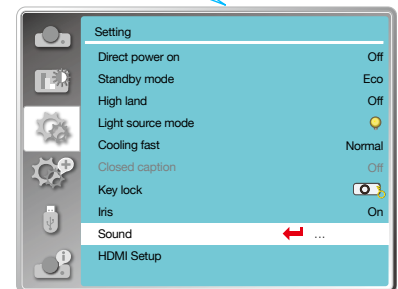
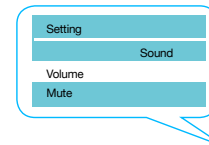

Basic operation

Remote control operation

Use your remote control for common operations.

Freeze (FREEZE)

Press the FREEZE button on remote control to freeze image and mute the audio. Freeze icon appears on the screen. Press the FREEZE button or any button to cancel the freeze function, then the image replay and the sound is restored.

Mute (MUTE)

Press the mute button on the remote control to turn off the sound. To remove the mute function, please press the mute button or Volume +/- button to cancel the mute function.

VOLUME +/- (VOLUME +/-)

Press the Volume +/- on remote control to increase or decrease volume.

IMAGE (IMAGE)

Press the IMAGE button on remote control to select required image mode.

LAMP (LAMP)

Press the Lamp button on remote control to change screen brightness.

 Normal Normal brightness.

 ECO Lower the brightness and reduce energy consumption, thus prolonging the lamp service life.

INFO. (INFO.)

Press the information button on the remote control to display the information of the projected image and the projector's operating status.

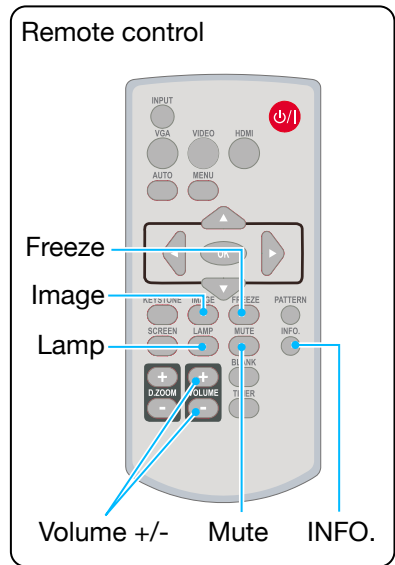

Note

For some other buttons' description, please refer to the next page.

Basic operation

Blank (BLANK)

Press the BLANK button on remote control; a blank screen displays to replace existing image. Press the BLANK button or any other button to restore the image.

Press the BLANK to toggle switch your screen as shown below:

BLANK → Normal → BLANK →
→ Normal →

Timer (TIMER)

Press the TIMER button on remote control. A timer animation (00:00) displays on the upper right corner and starts timing in format of (00:00-59:59).

Press the TIMER button to stop timing. Press the TIMER button again to disable the timing function.

Digital Zoom + (D.ZOOM+)

Press the D.ZOOM+ button on remote control to enter the Digital Zoom mode.

When OSD menu disappear, the screen display digital zoom + information.

*Only for input as VGA, RGBHV, and the screen size setting as Normal or Wide.

Digital Zoom - (D.ZOOM-)

Press the D.ZOOM- button on remote control to enter the Digital Zoom mode.

When OSD menu disappear, the screen display digital zoom - information.

Press any other key to exit the digital zoom +/- mode.

Screen size selection (SCREEN)

Press the SCREEN button on remote control to select required screen size mode.

Press the SCREEN button on the remote control to select the size of the screen to return to the normal screen size.



The BLANK screen disappears if no buttons are pressed in 2 seconds.



Timer display

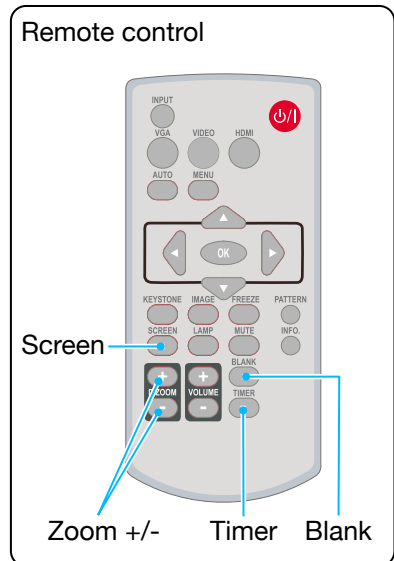

Input selection

Basic operation

Press the INPUT button on the control panel or on the remote control to select one of the following input: VGA, Video, HDMI 1, HDMI 2, Memory Viewer, Network, USB Display. Alternatively, you may press the VGA, HDMI VIDEO button on remote control to select VGA, HDMI1, HDMI 2, VIDEO.

Menu operation

1. Press the INPUT button on remote control to enter the Input menu.
2. Press ▲▼ button to select one of the following input: VGA, video, HDMI 1, HDMI 2, Memory Viewer, Network, USB Display, and then press the <OK> button to select the input source.

VGA	Select input VGA if a PC is connected to the VGA IN terminal.
HDMI 1	Select input HDMI 1 if a device is connected to the HDMI terminal.
HDMI 2	Select input HDMI 2 if a device is connected to the HDMI 2 terminal.
Video	Select input Video if a PC is connected to the Video terminal.
Network	Select input Network if a device is connected to the LAN terminal.
Memory Viewer	Select input Memory Viewer if a device is connected to the USB-A terminal.
USB Display	Select input USB Display if a device is connected to the USB-B terminal.

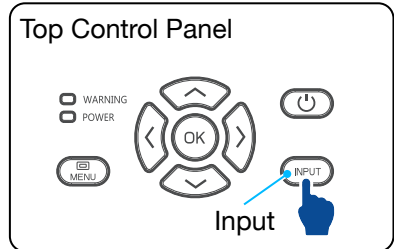
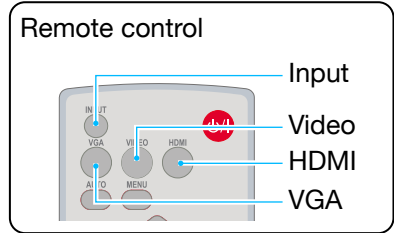

Input menu

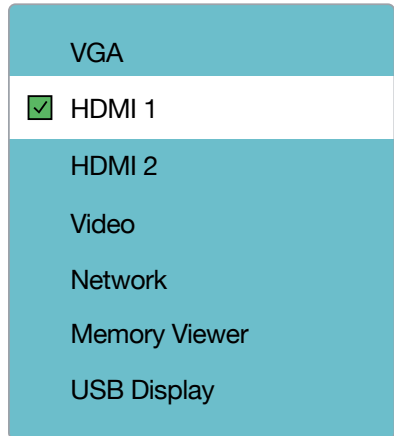



Note

- If the "Input search" function in the auto setup option is set to "On", once you press the AUTO button, the projector will search for input signals automatically. The auto searching function maybe invalid for input of "USB Display", "Memory Viewer" and "Network".
- The following function will be invalid: FREEZE, ASPECT, IMAGE, AUTO SETUP, PATTERN and SCREEN, once "USB Display", "Memory Viewer", "Network" has been selected as signal input.
- For further details about Memory Viewer function, please turn to page 83-85.
- For further details about USB Display function, please turn to 86-87.

Auto PC adj.

Select Auto PC Adj. function to adjust Fine sync, H position, V position, H size to be compatible with the computer automatically.

Menu operation

Auto PC adj.

Press < MENU > button on the remote control or on the top control panel to display the OSD menu. Press ▲▼ button to select the display menu, then press <OK> or ► button.

1. Press ▲▼ button to select [Auto PC adj.] menu.
2. Press <OK> button.

Fine sync

(Only for PC signal input)

Adjust image to the best state when the image jitters, or the image outline dims.

1. Press ▲▼ button to select [Fine sync] menu.
2. Press <OK> button.
3. Press ▲▼ button to adjust Fine sync.

Adjustment range is from 0 to +31. Please adjust to the least interference state.

H Position

(Only for PC signal input)

On the premise that the relative position of both projector and the screen is set up right, you can move the image horizontal position, if the position of the projected image on the screen is deviated.

1. Press ▲▼ button to select [H position] menu.
2. Press <OK> button.
3. Press ▲▼ button to adjust image H position.

Adjustment range is from -5 to +5.

Auto PC adj. menu

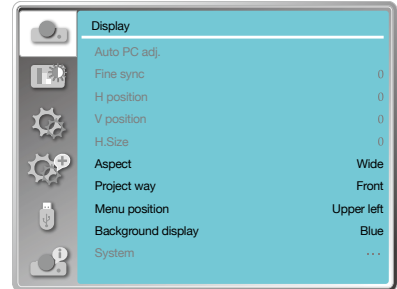

Note

- The projector will perform Auto PC Adjustment function automatically, when its signal is input for the first time.
- Auto PC Adjustment function may fail to work if computer models is not compatible with the input signal.
- Auto PC Adjustment function may fail to work if you select the following system signal format: 480i, 576i, 480p, 576p, 720p, 1080i, 1080p, or signals from the HDMI terminal.

H position menu

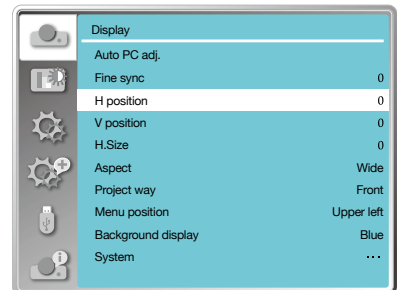

V position

(Only for PC signal input)

On the premise that the relative position of both projector and the screen is set up right, you can move the image vertical position, if the position of the projected image on the screen is deviated.

1. Press ▲▼ button to select [V position] menu.
2. Press <OK> button.
3. Press ▲▼ button to adjust image V position.

Adjustment range is from -5 to +5.

H.Size

(Only for PC signal input)

You can adjust and reduce the interference caused by patterns of the projected vertical stripes. The following projected patterns may cause a circular pattern (Noise). Adjust the amount of interference to the minimum. Users can point the clock to adjust images.

1. Press ▲▼ button to select [H.Size] menu.
2. Press <OK> button.
3. Press ▲▼ button to adjust H.Size level.

Adjustment range is from -15 to +15.

Aspect

Adjust the image to fit the screen size, while keeping aspect of input signal's unchanged.

Press < MENU > button on the remote control or on the top control panel to display the OSD menu. Press ▲▼ button to select the display menu, then press <OK> or ► button.

1. Press ▲▼ button to select [Aspect] menu.
2. Press <OK> button.
3. Press ▲▼ button to select the required item.

Normal

Use the maximum size to project while keeping the aspect of input signal's unchanged.

V position menu

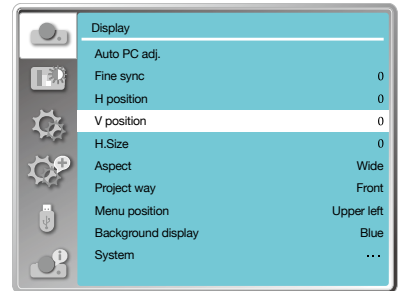

H.Size menu

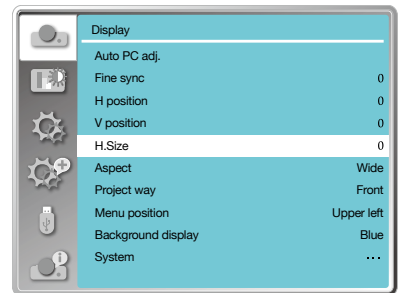

Aspect menu

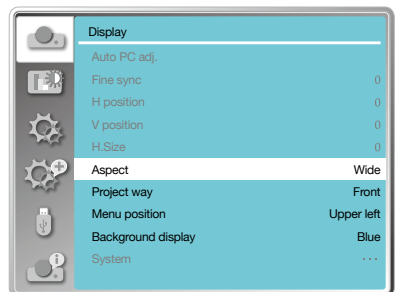

Display

Wide

Project images at the aspect of 16:9.

Full

Project images to the maximum.
• Only for PC (VGA) signal input.

Advanced

Splicing screen.
• Only for PC (VGA) signal input.

1. Press ▲▼ button to select [Aspect] menu.
2. Press <OK> button.
3. Press ▲▼ button to select [Advanced] menu.
4. Press <OK> button.
5. Press ▲▼ button to select the required item.

H total

Set the H total, and images will be vertical division by the set value.

Adjustment range is from 1 to 5 of widescreen.

V total

Set the V total, and images will be horizontal division by the set value.

Adjustment range is from 1 to 5 of widescreen.

Position H

Set the projector in horizontal position.
Adjustment range is from 1 to the current H total value.

Position V

Set the projector in horizontal position.
Adjustment range is from 1 to the current V total value.

Project way

Select this function to set the placement or installation of the projector.

Please change the settings in this menu option, if the OSD displays inversely or reversely.

Press < MENU > button on the remote control or on the top control panel to display the OSD menu. Press ▲▼ button to select the Display menu, then press <OK> or ► button.

Project way menu

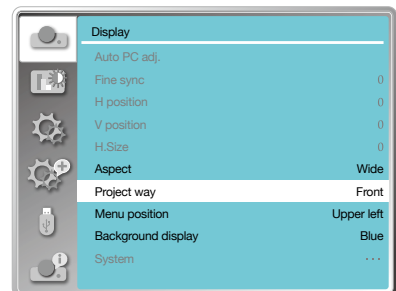

Display

1. Press ▲▼ button to select [Project way] menu.
2. Press <OK> button.
3. Press ▲▼ button to switch.

Front

When the projector is installed on the table and projected in front of the screen.

Rear

When the projector is installed on the table and projected in rear of the screen (using translucent screen).

Ceiling /
Front

When use the bracket to lift the projector (optional) in front of the screen.

Ceiling /
Rear

When use the bracket to lift the projector (optional) in rear of the screen (using translucent screen).

Auto ceiling /
Front

When the projector is projected in front of the screen.

Auto ceiling /
Rear

When the projector is projected in rear of the screen.

Menu position

Select this function to set the menu position.

Press < MENU > button on the remote control or on the top control panel to display the OSD menu. Press ▲▼ button to select the display menu, then press <OK> or ► button.

1. Press ▲▼ button to select [menu position] menu.
2. Press <OK> button.
3. Press ▲▼ button to change menu position.

Upper left

The menu display on the upper left corner of the screen.

Upper right

The menu display on the upper right corner of the screen.

Centre

The OSD display in the centre of the screen.

Lower left

The menu display on the lower left corner of the screen.

Menu position menu

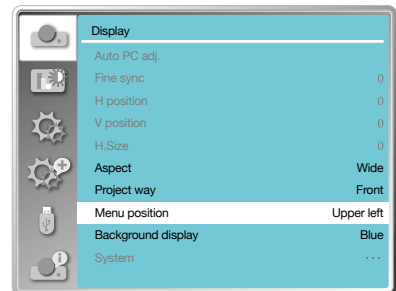

Display

Lower right The menu display on the lower right corner of the screen.

Background display

Select this function can adjusts background colour.

Press < MENU > button on the remote control or on the top control panel to display the OSD menu. Press ▲▼ button to select the display menu, then press <OK> or ► button.

1. Press ▲▼ button to select [Background display] menu.
2. Press <OK> button.
3. Press ▲▼ button to select required item.

Blue The entire projection area display blue.

Black The entire projection area display black.

System

System selection

The scanning system and auto computer adjustment function will detect the signal format. If a PC is selected as the input signal source, your projector will detect and adapt to its signal format automatically. The projected image can be displayed without any setup operation.

Your projector will display one of the following:

Auto If your projector failed to identify signals not shown in the signals format table, the “Auto” message will display in the System Signal Format menu. The Auto PC Adjusting function will make necessary adjustment to your projector to project valid images. If images are displayed incorrectly, adjust it manually.

----- No PC signals detected. Check the connection between PC and your projector.

Background display menu

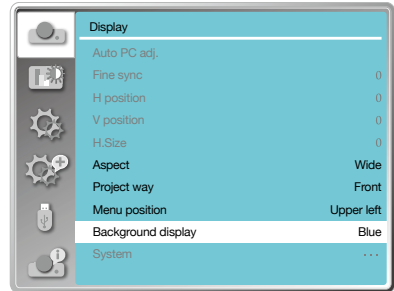

Note

This function will be invalid once you select input signal as USB display, Memory Viewer or Network.

System Signal Format menu

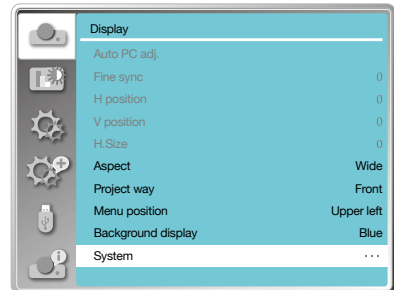

Note

Your projector may save data generated by the Auto PC Adjusting function.

Note

The computer system menu will be disabled if HDMI 1, HDMI 2, Memory Viewer, Network, USB Display have been selected.

Select the computer system manually

1. Press the MENU button on remote control and the OSD displays. Press ◀▶ button to point to the Input icon, press ▲▼ button or <OK> button and the Input menu displays.
2. Press ▲▼ button to select System Signal Format, then press <OK> button.
3. Press ▲▼ button to select required system signal format, then press <OK> button to confirm your selection.

Video

Select this function to set resolution of input signal to be compatible with the PC.

Set Video / S-video input signal colour system or Component input signal scanning mode.

1. Press ▲▼ button to select [System] menu.
2. Press <OK> button.
3. Press ▲▼ button to select wanted system.

System for PC signal

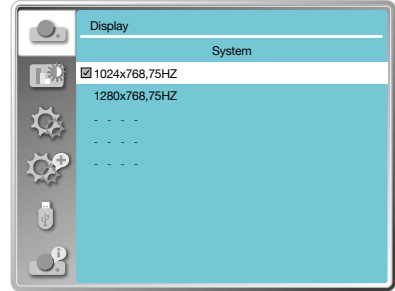

System for Video signal

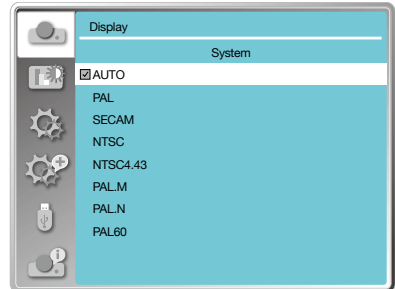

RGB input signal

- Display the compatible name input signal name.
- When projector has no compatible signal with one from connected PC, the PC can adjust automatically to run and Auto appear on the system. If the image is not projected out correctly, please adjust it to match your computer manually.
- No signal input come from PC. Please check the connections.

Video input signal

- When projector select the input signal colour system automatically. Set [PAL-M] or [PAL-N] manually.
- When projector can not display images correctly in [Auto], please set input signal colour system manually.

Select colour Adjustment to set the image mode and adjust the quality of the projected image.

Image mode

Direct operation

Press the Image mode button on remote control to select required image mode.

Menu operation

Press <MENU> button on the remote control or on the top control panel to display the OSD menu. Press ▲▼ button to select the colour adjust menu, then press <OK> or ► button.

1. Press ▲▼ button to select [Image mode] menu.
2. Press <OK> button.
3. Press ▲▼ button to select required item.

- | | |
|--------------------|---|
| Dynamic | An image mode suitable for viewing in bright room. |
| Standard | The default mode of your projector, for natural colour reproduction. |
| Cinema | Enriched greyscale for viewing movies. |
| Blackboard (Green) | An image mode designed for displaying on a blackboard (Green). It boosts quality of image projected on blackboard (Green). This is designed for a board in green rather than black as indicated by its name. |
| Colourboard | A image mode suitable for image projecting on surface of wall in red, blue, yellow or green. Press <OK> button to enter colourboard menu, then press ▲▼ button to select red, blue, yellow or green. Press <OK> button. |
| User Image | Default image mode set by users in the Image Adjust menu. |

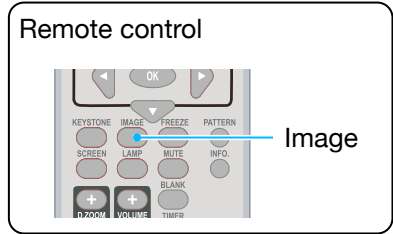
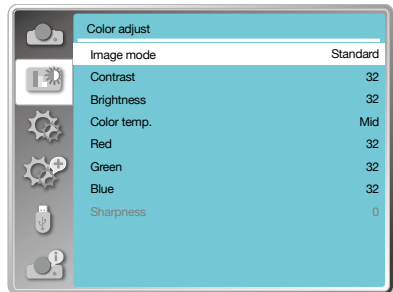
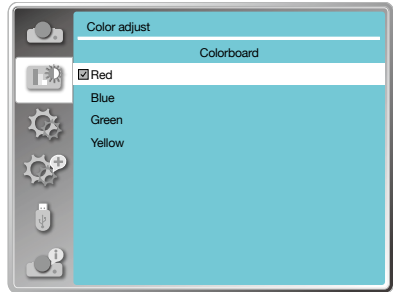

Image mode (For PC)



Colourboard



Colour adjust (For PC.)

Press <MENU> button on the remote control or on the top control panel to display the OSD menu. Press ▲▼ button to select the Colour adjust menu, then press <OK> or ► button.

1. Press ▲▼ button to select required item.
2. Press <OK> button.
3. Press ▲▼ button to adjust set point.

Contrast

Press ▼ button to decrease contrast, range from 0 - +63.
Press ▲ button to increase contrast, range from 0 - +63.

Brightness

Press ▼ button to decrease brightness, range from 0 - +63.
Press ▲ button to increase brightness, range from 0 - +63.

Colour temp.

Press ▲▼ button to select required colour temperature (Low, Mid. and High)

High

Become blue gradually.

Mid

Suitable natural colour.

Low

Become red gradually.

Red

Press ▼ button to decrease red tint and ▲ button to increase it.

Green

Press ▼ button to decrease green tint and ▲ button to increase it.

Blue

Press ▼ button to decrease blue tint and ▲ button to increase.

Sharpness

Press ▼ button to soften image and ▲ button to sharpen, range from 0 - +15.

Colour adjust (For PC)

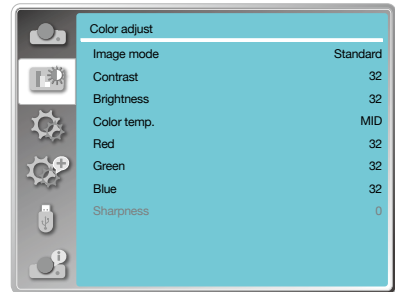

Colour adjust (For Video)

Press < MENU > button on the remote control or on the top control panel to display the OSD menu. Press ▲▼ button to select the Colour adjust menu, then press <OK> or ► button.

1. Press ▲▼ button to select required item.
2. Press <OK> button.
3. Press ▲▼ button to adjust set point.

Contrast

Press ▼ button to decrease contrast, range from 0 - +63.
Press ▲ button to increase contrast, range from 0 - +63.

Brightness

Press ▼ button to decrease brightness, range from 0 - +63.
Press ▲ button to increase brightness, range from 0 - +63.

Color

Press ▼ button to decrease saturation, press ▲ button to increase saturation.

Tint

Press ▲▼ button to select required tint.

Red

Press ▼ button to decrease red tint and ▲ button to increase it.

Green

Press ▼ button to decrease green tint and ▲ button to increase it.

Blue

Press ▼ button to decrease blue tint and ▲ button to increase.

Sharpness

Press ▼ button to soften image and ▲ button to sharpen, range from 0 - +15.

Colour adjust (For Video)

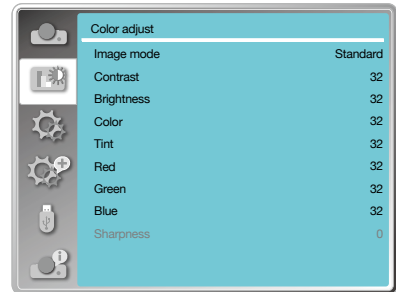

Note

- Tint and colour option are available if you choose Video, S - video or component as signal, while other signals result in two of them invalid.

The projector has Setting function, you can select other functions as described below.

Menu operation

Press < MENU > button on the remote control or on the top control panel to display the OSD menu. Press ▲▼ button to select the setting menu, then press <OK> or ► button.

1. Press ▲▼ button to select required item.
2. Press <OK> button.
3. Press ▲▼ button to set options.

Direct power on

Set the power mode ON, when the power cord is connected to a power outlet.

1. Press ▲▼ button to select [Direct power on] menu.
2. Press <OK> button.
3. Press ▲▼ button to select required item.

Off

Get into standby mode.

On

Start up immediately.

Standby mode

Set power consumption in standby mode, no matter whenever your projector is operated through network.

1. Press ▲▼ button to select [Standby mode] menu.
2. Press <OK> button.
3. Press ▲▼ button to adjust levels.

ECO

Some function will be disabled once your projector is in ECO standby mode to reduce power consumption. Network and RS-232C serial communication will be unavailable except the POWER on command during that mode.

Setting menu

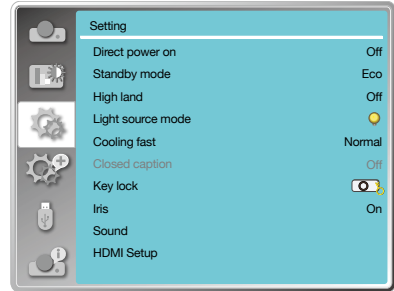

Direct power on

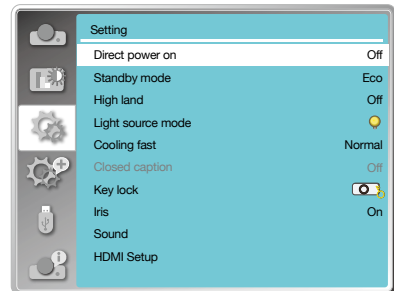

Standby mode

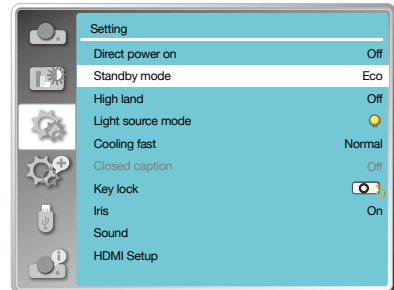

Setting

Network

In order to reduce power consumption, some functions in standby mode will be limited. Under network standby, network function is not available and RS-232C serial communication (except boot command) function is not available.

- Standby mode network wake-up function can only use the "Wake On LAN" tool.

Normal

In order to reduce power Even in standby mode, there are no restraint on network function and serial communication function.

High land

This projector provides fan control function in the settings menu. You can change the setting about speed of cooling fan according to the altitude your projector is operating at.

1. Press ▲▼ button to select [High land] menu.
2. Press <OK> button.
3. Press ▲▼ button to select required menu.

Off

Normal speed. Set the option off when operating the operator, if the altitude is not too high.

On

Faster than when in off mode. Set the option on when operating the operator in high land.

Light source mode

Change lamp brightness according to the environment and aim your projector is operating.

1. Press ▲▼ button to select [Light source mode] menu.
2. Press <OK> button.
3. Press ▲▼ button to switch required menu.



Normal

Normal brightness.



ECO

Lower the brightness and reduce energy consumption, thus prolonging the lamp service life.

High land

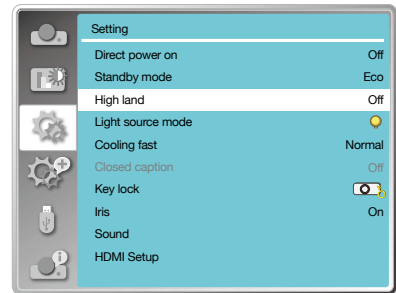

Note

- Set high land option ON when you operate the operator at an altitude of 1400-2000 meters.

Light source mode

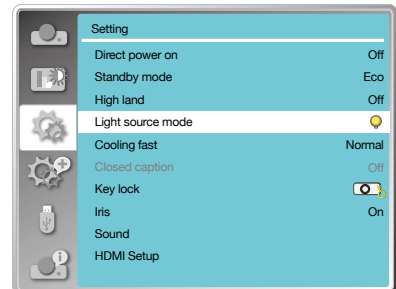

Cooling fast

After your projector is powered off, select cooling fan speed to shorten the cooling time.

1. Press ▲▼ button to select [Cooling fast] menu.
2. Press <OK> button.
3. Press ▲▼ button to switch required menu.

- | | |
|--------|--|
| Normal | Running in normal way. |
| 60 Sec | Running faster than in normal mode with shorter time but a louder sound. |
| 0 Sec | Select this function allow you to unplug the AC power directly after the shut down, without waiting for the projector cooling off. |

Closed caption

Closed Caption is used for displaying the program sound or other information on the screen. Select this function to switch channel with input signal of closed caption.

1. Press ▲▼ button to select [Closed caption] menu.
2. Press <OK> button.
3. Press ▲▼ button to switch required menu.

- | | |
|-----|--------------------|
| Off | No closed caption. |
| CC1 | Display CC1 data. |
| CC2 | Display CC2 data. |
| CC3 | Display CC3 data. |
| CC4 | Display CC4 data. |

Cooling fast

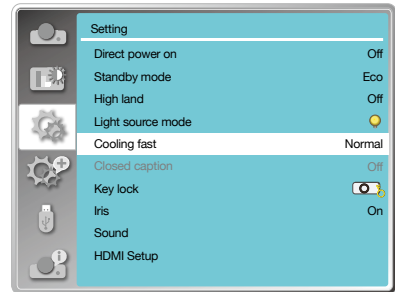

Note

- When set the option 0 seconds, user cannot restart the projector immediately after turning off it.
- While sometimes, the lamp may take a longer time to cool off than usual to light again for high temperature.

Closed caption

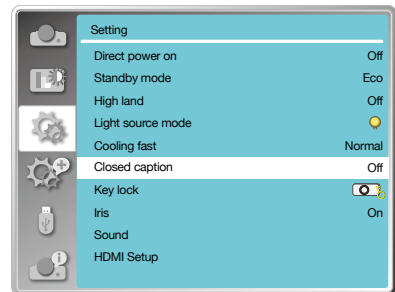

Note

The icon display grey if the Closed caption function is invalid.

- The Closed caption function is invalid when the OSD menu and Timer display on the screen.

Setting

Key lock

Select this function to lock and unlock the control panel or remote control keypad.

1. Press ▲▼ button to select [Key lock] menu.
2. Press <OK> button.
3. Press ▲▼ button to switch required menu.



The control panel or remote control keypad are effective.



Control panel keypad is invalid.



Remote control keypad is invalid.

Iris

Select this function to correct and compensate signal automatically on the basis of the image, to get the best contrast image.

1. Press ▲▼ button to select [iris] menu.
2. Press <OK> button.
3. Press ▲▼ button to adjust levels.

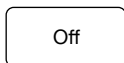

No correction.

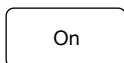

Correct iris.

Sound

Select this function to adjust the sound.

1. Press ▲▼ button to select [Sound] menu.
2. Press <OK> button.
3. Press ▲▼ button to switch required menu.

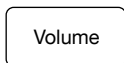

Press ▲ button to increase volume, range from 0~+25.
Press ▼ button to decrease volume, range from 0~+25.

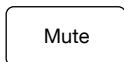

Press ▲▼ button to switch on or off Mute function.



No audio output.



Audio output.

Key lock

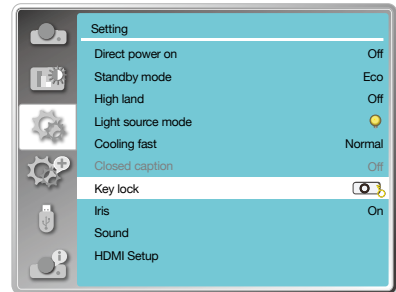

! Note

- If you lock the top of the control panel, but without a remote control or something wrong with the remote control, please contact your dealer or service centre.

Iris

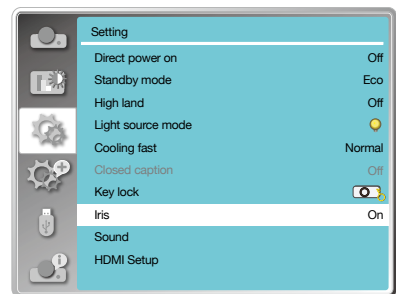

Sound

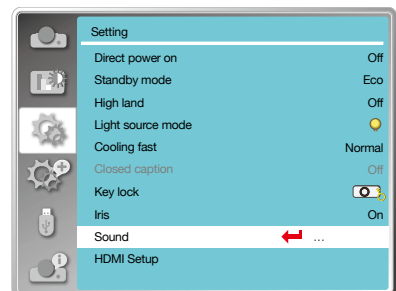

HDMI setup

When the external device is connected to the HDMI terminal of the projector, and the images can not be projected normally, please switch on the Image or Sound setting.

Press < MENU > button on the remote control or on the top control panel to display the OSD menu. Press ▲▼ button to select the setting menu, then press <OK> or ► button to enter the sub-menu.

1. Press ▲▼ button to select [HDMI setup] menu.
2. Press <OK> button.
 - Display [HDMI setup] instantly.
3. Press ▲▼ button to select [Image] or [Sound].
 - Press <OK> button.

HDMI Setup

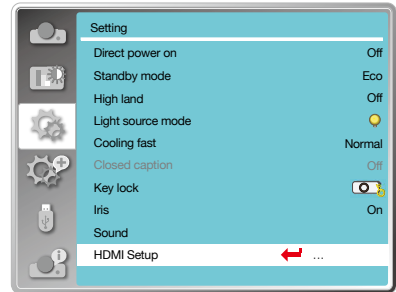

Note

- HDMI option can be chosen only in HDMI 1 and HDMI 2 channel.

Image

[64-940]	When external device (such as: a blu ray disc player) is connected to the HDMI setup terminal.
[0-1023]	When the output of an external device (such as a computer), via a conversion cable or a similar cable, is connected to the HDMI setup terminal. Select this option when the output of the pc or any other device is connected to the HDMI setup terminal also.

Sound

[HDMI]	When connect to the HDMI cable to transmit images and audio while the users do not need connect to audio signal separately.
[Computer]	When the output of an external device (such as a computer), via a conversion cable or a similar cable, is connected to the HDMI terminal. The audio signal would be output according the connection of AUDIO IN terminal.

HDMI EQ setup

Mode 0-3	Change the HDMI reception level according to the AV device connected to the HDMI input terminal. If noise appears in the image or the image does not appear, change the settings.
----------	---

The projector has Expand function, you can select other functions as described below.

Menu operation

Press < MENU > button on the remote control or on the top control panel to display the OSD menu. Press ▲▼ button to select the expand menu, then press <OK> or ► button.

1. Press ▲▼ button to select required item.
2. Press <OK> button.
3. Press ▲▼ button to set options.
4. Press <OK> button.

Language

Users can selected the language displayed on the screen.

1. Press ▲▼ button to select [Language] menu.
2. Press <OK> button.
3. Press ▲▼ button to select required language.
4. Press <OK> button.

The name of menus, setting, the OSD, button etc., can displayed by the selected language.

Your projector comes with multiple language support. You may select required one from them, such as: English, German, French, Italian, Spanish, Polish, Swedish, Dutch, Portuguese, Japanese, Simplified Chinese, Traditional Chinese, Korean, Russian, Arabic, Turkey, Finland, Norway, Denmark, Indonesia, Hungary, Czech Republic, Kazakhstan, Vietnamese, Thai, Farsi.

Expand menu

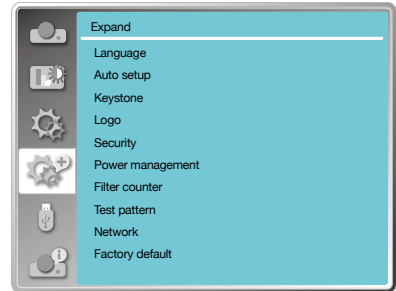

Language

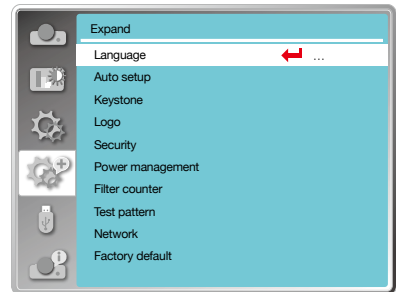

Auto setup

Press the AUTO button on your remote control to execute the following functions: Input search, Auto PC adj., and Auto keystone.

1. Press ▲▼ button to select [Auto setup] menu.
2. Press <OK> button.
3. Press ▲▼ button to select required items.

Input search Select this function to detect the signal, then project images and input signals automatically.

Auto PC adj. Select this function to adjust [Fine sync], [H Position], [V Position] and [H.Size] automatically, when projector input analogue signals.

Auto keystone Select this function to correct vertical distortion of the projected image automatically.

Keystone

Select this function to store or reset the keystone or some related setting after unplugging the AC power.

Press < MENU > button on the remote control or on the top control panel to display the OSD menu. Press ▲▼ button to select the expand menu, then press <OK> or ► button to enter.

1. Press ▲▼ button to select [Keystone] menu.
2. Press <OK> button.
3. Press ▲▼ button to select required item.
4. Press <OK> button.

Auto setup

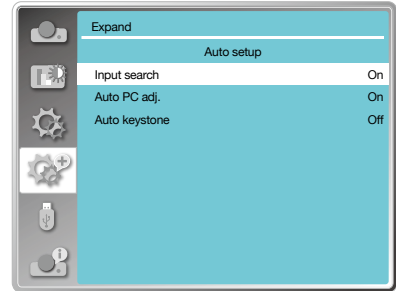

Note

- One of input search, Auto PC adj. and Auto keystone option should be set to On at least.
- Please adjust the projector manually, if the image is displayed abnormal even if you have select auto keystone function.
- When you set Project way as Ceiling / Front or Ceiling / Rear, Auto keystone function is invalid.
- When you set Project way as Auto ceiling / front or Auto ceiling / rear, and users put their projector in ceiling state, the Auto keystone function will be invalid.

Keystone

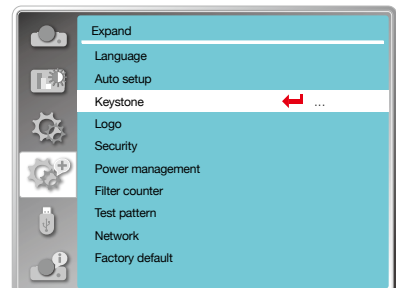

Keystone

Select this function to store and reset keystone after closing the projector or unplugging the AC power.

- This function is only when the option about auto keystone is not set On.

Store Store keystone after closing the projector or unplugging the AC power.

Reset Keystone function will be cancelled after closing the projector or unplugging the AC power when the standby mode is set to ECO. mode. When the standby mode is set to normal, keystone will be cancelled if you unplug the AC power; while it will be stored when closing the projector.

Keystone sub-menu

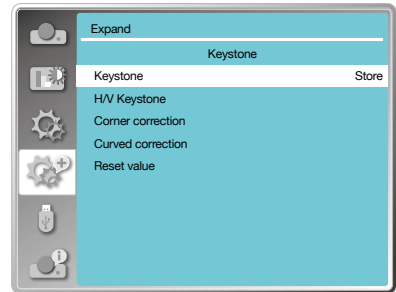

H/V Keystone

Select this function to correct the projected images horizontally or vertically.

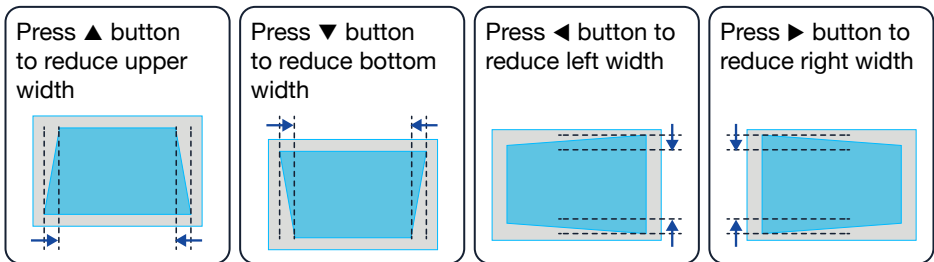

4-Corner correction

Select this function to correct the projected images of four corners distorted.

Press ▲▼◀▶ button to keystone at four corners of the screen. The four corners are looped in sequence shown below:

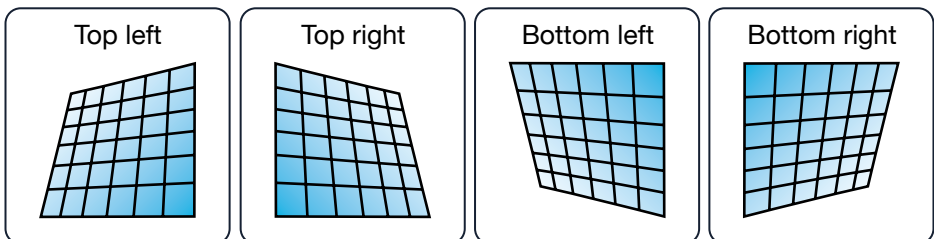

6-Corner correction (Only for WUXGA series)

Select this function to correct the projected images of six corners distorted.

Press ▲▼◀▶ button to keystone at six corners of the screen. The six corners are looped in sequence shown below:

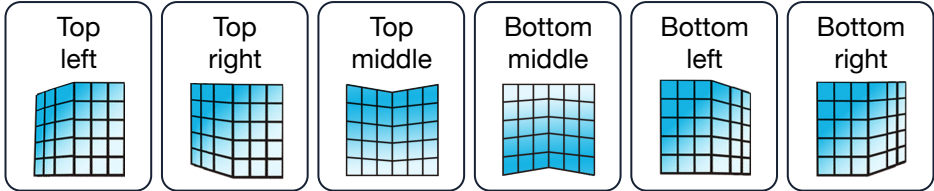

Curved correction (Only for WUXGA series)

Select this function to correct the projected images with linearity uneven or vertical and horizontal bending deformation. Press ▲▼◀▶ button to adjust options.

Item	Operation	Adjustment	
Curved correction X/Y gain	Press ▶	Extend left and right vertically.	
	Press ◀	Sag left and right vertically.	
	Press ▲	Reach up and down horizontally.	
	Press ▼	Sag up and down horizontally.	
Curved correction X offset	Press ◀	Correct the vertical lines on the left. Expand the top and bottom while maintaining the central area.	
	Press ▶	Correct the vertical lines on the right. Expand the top and bottom while maintaining the central area.	
	Press ◀	Correct the horizontal line on the left. Expand the top and bottom while maintaining the central area.	
	Press ▶	Correct the horizontal line on the right. Expand the top and bottom while maintaining the central area.	

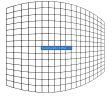
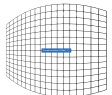
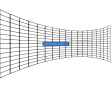
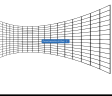
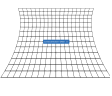
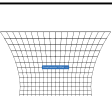
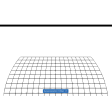
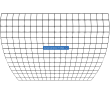
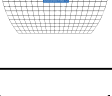
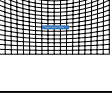
Item	Operation	Adjustment	
Curved correction X offset	Press ◀	Correct the horizontal line on the left. Expand the top and bottom while maintaining the central area.	
	Press ▶	Correct the horizontal line to the right. Expand the top and bottom while maintaining the central area.	
	Press ◀	Correct the horizontal line on the left. Expand the top and bottom while maintaining the central area.	
	Press ▶	Correct the horizontal line to the right. Expand the top and bottom while maintaining the central area.	
Curved correction Y offset	Press ▼	Correct vertical lines on both sides. Expand the lower corners while maintaining the central and upper regions.	
	Press ▲	Correct vertical lines on both sides. Expand the top corners while maintaining the central and upper regions.	
	Press ▼	Correct vertical lines on both sides. Expand the lower corners while maintaining the central and upper regions.	
	Press ▲	Correct vertical lines on both sides. Expand the top corners while maintaining the central and upper regions.	
	Press ▼	Correct vertical lines on both sides. Expand the lower corners while maintaining the central and upper regions.	
	Press ▲	Correct vertical lines on both sides. Expand the upper corner while keeping the central and lower regions unchanged.	



Note

- After adjusting values about H/V keystone, if users adjust conner correction, values about H/V keystone will be reset, and after adjusting values about conner correction, if users adjust about H/V keystone, values about conner correction will be reset also.
- Curved correction X offset and curved correction y offset can not be adjusted individually. Adjust curved correction X offset and curved correction y offset after adjusting the X/Y curved correction.
- Maximum keystone range up to $\pm 30^\circ$ vertically and $\pm 30^\circ$ horizontally. However, the image quality will deteriorate, and become more difficult to focus. install the projector with the minimal correction value.
- The screen size will be changed with various H/V keystone adjustments .
- Keystone may influence image aspect.

Grid image tune (Only for WUXGA series)

Select this function to adjust the local points of the projected image.

1. Press **▲▼◀▶** button to select [Grid image tune] option.
2. Press <OK> button.

Reset value

Select this function to make adjustment value back to the factory default.

1. Press **▲▼◀▶** button to select [Reset value] option.
2. Press <OK> button.
 - Release keystone mode.

Logo

(including Logo and Logo PIN Code lock setup)

You may use this function to select Logo screen, Logo PIN Code lock, change power on password, and set up default logo screen.

1. Press ▲▼ button to select [Logo] menu.
2. Press <OK> button.
3. Press ▲▼ button to select required items.

Logo Select

Select this to set up the logo screen when power on your projector:

- | | |
|-------------------------------|--------------------------------------|
| <input type="radio"/> Default | Display factory default logo screen. |
| <input type="radio"/> User | Display capture logo screen. |
| <input type="radio"/> Off | Display countdown logo screen. |

Capture

You can capture a projected image as start logo. Select "Capture" and press the <OK> button on remote control or control panel. Confirmation dialog box appears, select "Yes" to start capturing.

Logo PIN Code lock

This function helps preventing unauthorized personnel from changing the Logo screen.

- | | |
|------------------------------|--|
| <input type="checkbox"/> Off | The Logo screen may be changed with the Logo menu. |
| <input type="checkbox"/> On | You may not alter the logo screen without the Logo PIN Code. |

To change the logo screen password protection, press <OK> key, and the Logo PIN Code change pop-up dialogue box prompts. Follow steps below to enter a logo screen password.

- Press arrow ◀▶ button to select a number, then press <OK> button to enter it and move the cursor. The number you typed is displayed as “ * ”. To edit number you have

Logo menu

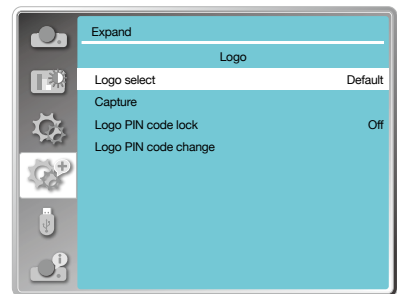
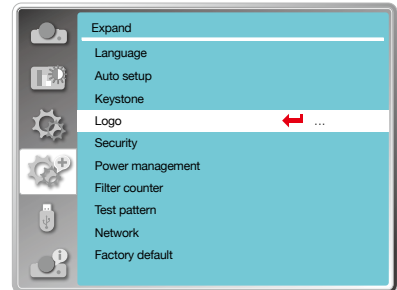

entered, press <MENU> button to move the cursor to the number you want to change, press ▲▼ button to select the correct one.

- Repeat this step to type in a 3-digit number. Move the cursor to set after you have typed the 3-digit number. Press <OK> button.
- If the password is invalid, the password displayed as “*** ” will be in red. Please try again with a valid one.
- After you have entered valid logo screen PIN code, you may press ◀▶ button to toggle switch Off and On.

Logo PIN Code change

You may change the Logo PIN Code to any 3-digit number you like. Press OK key to select Logo PIN Code change. The Logo PIN Code change dialogue box prompts, press arrow ◀▶ button to give a valid new code. The New Logo PIN Code dialogue box prompts. Set up a new Logo PIN Code, check contents contained in the dialogue box, select Yes and the new password is set now.

Please remember your new password and keep it safe. You cannot change the Logo PIN Code again if you forgot the password you have set.

Security

Set a password to lock the control panel or remote control keypad to prevent unauthorized personnel from operating your projector. Once the projector is on, the [Enter Password] screen will be displayed.

1. Press ▲▼ button to select [Security] menu.
2. Press <OK> button.
3. Press ▲▼ button to switch required item.

PIN Code lock

This function prevents the projector from being operated by unauthorized persons and provides the following setting options:

Off

Unlocked.

Note

- After changing the Logo PIN Code to a new number, please remember it and keep it safe. The Logo PIN Code cannot be changed again if the new password is lost or forgotten.

Security menu

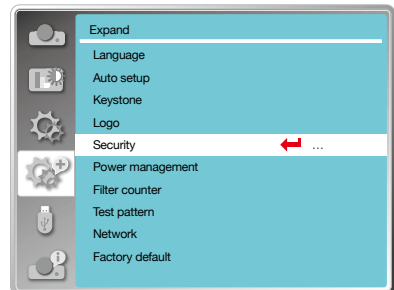

On

The [Enter Password] screen will appear when the projector is on. If you want to change the PIN code lock or password (for three digits), you must enter the password. The factory default password is "111".

Reset password

To change the password protection, press <OK> button, and the PIN Code change pop-up dialogue box prompts.

- Press arrow ◀▶ button to select a number, then press <OK> button to enter it and move the cursor.
- The number you typed is displayed as "***". To edit number you have entered, press menu button to move the cursor to the number you want to change, press ◀▶ button to select the correct one.
- Repeat this step to type in a 3-digit number.
- Enter a three-digit number, move the cursor to "set". Press the <OK> button, you can start to operate the projector.
- If the password is invalid, the password displayed as "***" will be in red. Please try again with a valid one.

PIN Code Change

You may change the PIN Code to any 3-digit number you like.

- Press OK key to select PIN Code change.
- The PIN Code change dialogue box prompts, press arrow ◀▶ button to give a valid new code.
- The New PIN Code dialogue box prompts. Set up a new PIN Code, check contents contained in the dialogue box, select set and the new password is set now.
- Please remember your new password and keep it safe. You cannot change the PIN Code again if you forgot the password you have set.

Security submenu

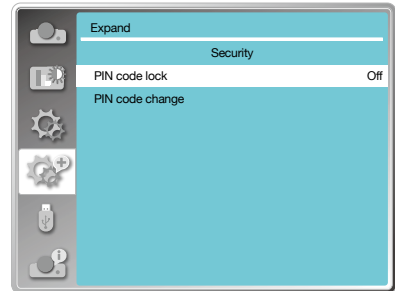

Note

- After changing the PIN Code to a new number, please remember it and keep it safe. The PIN Code cannot be changed again if the new password is lost or forgotten.

Power management

To reduce power consumption and maintain life cycle of lamp, the power management function will turn off the projection lamp if your projector has no signals for a period of time.

1. Press ▲▼ button to select [Power management] menu.
2. Press <OK> button.
3. Press ▲▼ button to switch required item.

Ready

The Power light indicator flashes green when the lamp is fully cooled down. The lamp turns on again if an input signal is connected or any key (except the  power button) on the rear panel and remote control is pressed during this period of time.

Shut down

The projector shut down after the lamp is fully cooled down.

Off

Disable the power management function.

Timer

Once the input signal is interrupted and no keys has been pressed for 30 seconds afterwards, the “No signal” message displays in the timer. The timer counts down until the lamp turns off. Press arrow key to set up the timer in range of 1~30 minutes.

Ready countdown

- Set up the interval from ready mode change to standby (0 to 30 minutes) automatically. A setting of zero minutes keeps your projector from auto transition.
- Press the Power key to change your projector from ready to standby mode and any other key to power it on.

Power management menu

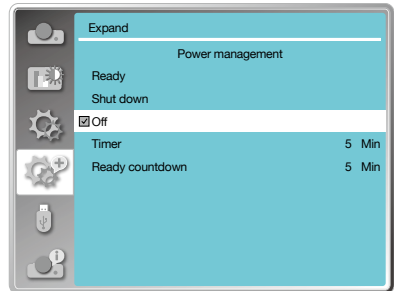
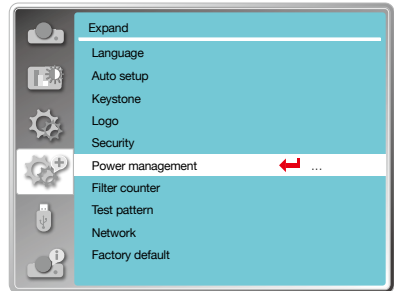

Remaining time before power off the lamp.

Note

- Factory default:
Timer: 5 minutes;
Ready countdown mode: 5 minutes.

Filter counter

Set this function to reset the filter usage time and set up warning display.

1. Press ▲▼ button to select [Filter counter] menu.
2. Press <OK> button.
3. Press ▲▼ button to switch required item.

When the projector reaches the user-set cleaning time, filter warning icon will appear on the screen to notify the user needs to clean the projector filter. Please make sure to select the initial state and set the timer after cleaning it. Once resetting filter counter, filter warning icon will be closed.

- | | |
|----------------------|---|
| Filter counter | Displays the filter usage time. |
| Timer | Set the time to display a warning icon. |
| Filter counter reset | Reset filter counter. |
| Filter check | Check the temperature inside the projector and make reactions. |
| On | Check filter. |
| | <ul style="list-style-type: none"> • Once the projector has checked any filter problem the screen will display a warning icon "Filter warning! Please change the filter!". |
| Off | DO NOT check filter. |

Filter counter menu

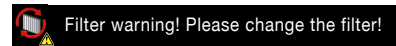
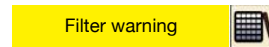
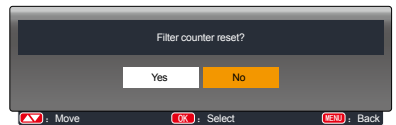
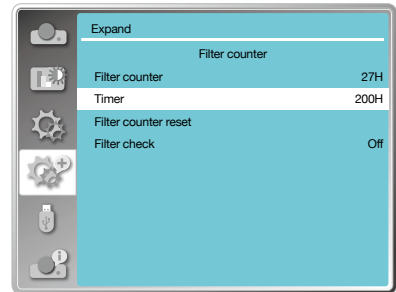

Note

- The screen will display the icon "Filter warning! please change the filter!" when the projector has checked one warning. And the warning icon will disappear 30s later automatically, while only the power button is effective during that period.
- The projector will give warning again if the projector has checked filter block and will record the information.

Test pattern

Select this function to display the projector's built-in test pattern.

Location, size, and other factors cannot be reflected in the test pattern. Please make sure to display the input signal before performing various adjustments.

1. Press ▲▼ button to select [Test pattern] menu.
2. Press <OK> button.
3. Press ▲▼ button to switch required item.
4. Press <OK> button.

Gray scale 1, Gray scale 2, Gray scale 3, Gray scale 4, Colour bar, Red, Green, Blue, Cross hatch, White, Black, Raster gray

Use The OSD menu to display the test pattern. Choose the test mode can help you making a series of adjustments easily.

Factory default

This function resets all your settings to factory default.

1. Press ▲▼ button to select [Factory default] menu.
2. Press <OK> or ► button.
3. Press ◀► button to select Yes, then press <OK> button.

Test pattern menu

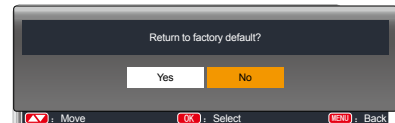
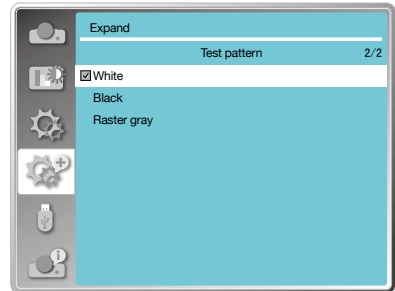
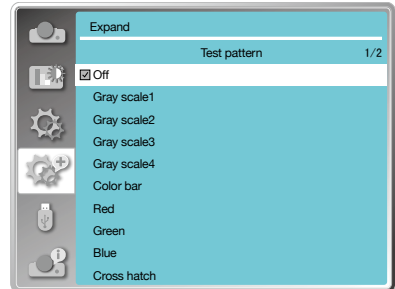

Network

This function is designed to allow the computer control on the projector remotely over your local network.

Preparation

1. Required equipment: Projector, computer, network cable
2. Connection:
Connect your projector to a router or switch in the LAN with normal or jumper network cable. In case a normal network cable failed to connect successfully, use a jumper cable instead.
3. Turn on the computer. The LAN port on computer and projector are flashing after power on the projector.

Operation steps

1. Power on your projector.
2. Acquire the IP address, with DHCP set to on and auto IP allocation set to On. (You may set DHCP to Off and set up IP address manually if you are somehow familiar with networking.)
3. Enter the network setup menu
 1. Press <MENU> button on remote control or top of the control panel, press ▲▼ button to select network icon.
 2. Press ▲▼ button select network settings and press <OK> button to enter.

MAC address Display the MAC address of wired network.

IP address Display the IP address of wired network.
 3. Press ▲▼ button to set DHCP On to obtain an IP address, subnet, gateway and DNS automatically, and press <OK> button to confirm.
Press ▲▼ button to set DHCP Off, then press <OK> button to enter an IP address, then press ▼ button to select subnet, gateway and DNS, and press <OK> button to confirm.

Network menu

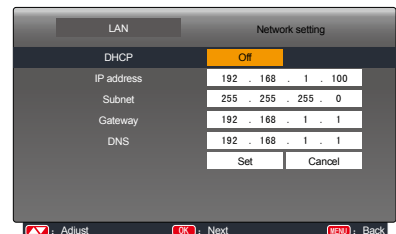
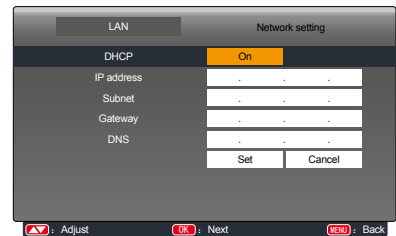
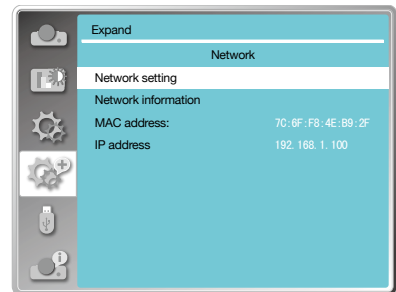

Select Memory Viewer function can project images stored in USB memory, when you insert the USB memory into the projector.

Press < MENU > button on the remote control to display the OSD menu. Press ▲▼ button to select the memory viewer menu, then press <OK> or ► button.

1. Press ▲▼ button to select required item.
2. Press <OK> button.
3. Press ▲▼ button to set options.
4. Press <OK> button.

Set slide

Select this function to play slides.

1. Press ◀▶ button to select a file.
2. Press ▲▼ button to select [Set slide] menu.
3. Press <OK> or ► button.
 - Full screen display.
 - Press <OK> to return the thumbnail.

Slide transition effect

Select this function to set the slide's playback, when switching slides.

1. Press ▲▼ button to select [Slide transition effect] menu.
2. Press <OK> or ► button.
3. Press ▲▼ button to switch required item.

Slide down

Switch slides from the upper to the lower.

Slide right

Switch slides from left to the right.

Note

USB play back requires the purchase of an optional USB memory drive, it is not supplied with the projector.

Memory viewer menu

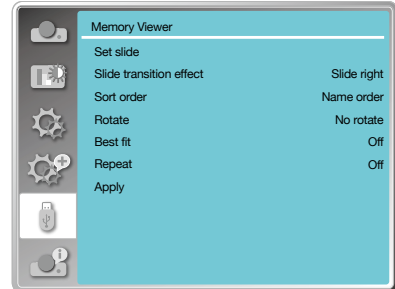

Note

- When selecting [Memory Viewer] as input signal, the "Memory Viewer" menu is available.
- In addition to "Set slide" menu, even change the settings, if you do not implement the [Apply], the setting value of the change is invalid.

Sort order

Select this function to set the slide's order.

1. Press ▲▼ button to select [Sort order] menu.
2. Press < OK > button.
3. Press ▲▼ button to switch required item.

Extend order	Sort by expand names of file or folder.
Size order	Sort by size of file or folder.
Time order	Sort by the time of file or folder.
Name order	Sort by names of file or folder.

Rotate

Set the rotation direction of images.

1. Press ▲▼ button to select [Rotate] menu.
2. Press < OK > button.
3. Press ▲▼ button to switch required item.

No rotate	Rotation is invalid.
270 Degree	Rotate counterclockwise by 270 degrees.
180 Degree	Rotate by 180 degrees.
90 Degree	Rotate counterclockwise by 90 degrees.

Note

USB play back requires the purchase of an optional USB memory drive, it is not supplied with the projector.

Best fit

Set the image to be compatible with projection screen.

1. Press ▲▼ button to select [Best fit] menu.
2. Press < OK > button.
3. Press ▲▼ button to switch required item.

On	Display images by the aspect ratio of the screen.
Off	Display image by the normal pixels.

Repeat

Select this function to play slides repeatedly.

1. Press ▲▼ button to select [Repeat] menu.
2. Press <OK > or ► button.
3. Press ▲▼ button to switch required item.

On	Replay the first document, after playing the last one.
Off	Return to the thumbnail display screen, after playing the last one.

Apply

Only be used in playing slides.

1. Press ▲▼ button to select [apply] menu.
2. Press <OK> or ► button.

Select Info. function to detect the projected image signal and the projector operating status.

Menu operation

Press < Info. > button on the remote control or < MENU > button on the control panel to display the OSD menu. Press ▲▼ button to select the info. menu, then press <OK> or ► button.

Info. display as follows:

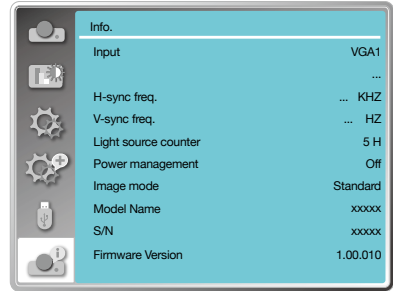

Input	Display selected input source.
H-sync. freq	Display H-sync. Freq. of input signal in unit of KHz. Show “---KHz” when no signals are in existence.
V-sync. freq	Display V-sync. Freq of input signal in unit of KHz. Show “---KHz” when no signals are in existence.
Light source counter	Display the lamp's usage time.
Power management	Display selected power management mode.
Image mode	Display selected image mode.
Model Name	Display the projector's model name.
S/N	Display the projector's serial number.
Firmware Version	Display the projector's firmware version.

Network control operation

This function is designed to remote control computer in the same LAN.

Preparation

1. Required equipment:
Projector, computer, network cable.
2. Connection:
Connect your projector to a router or switch in the LAN with normal or jumper network cable. In case a normal network cable failed to connect successfully, use a jumper cable instead.
3. Turn on the computer. The LAN port on computer and projector are flashing after power on the projector.

Operation steps

1. Power on your projector.
2. Acquire the IP address, with DHCP set to on and auto IP allocation set to On. (You may set DHCP to Off and set up IP address manually if you are somehow familiar with networking.)
3. Enter the network setup menu
 1. Press MENU button on remote control or top of the control panel, press ▲▼ button to select network icon.
 2. Press <OK> button or ► button and the network menu displays.
 3. Press ▲▼ button select network settings and press <OK> to confirm.
 4. Press ▲▼ button to set DHCP On and press <OK> button to confirm
 5. Press ▲▼ button to select Set, press <OK> button to wait until the "Please wait.." message disappears.

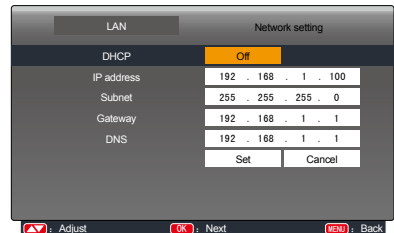
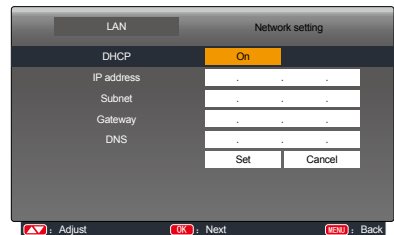
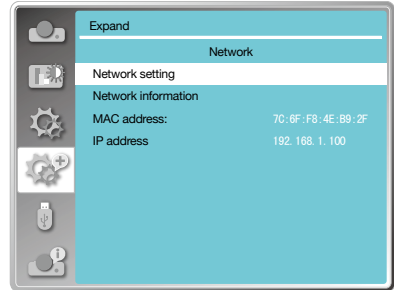

Note

- If you are using the wireless network connection, please check the SSID / ESSID and wireless IP address in the Network Setting status, and write down the information.

Installation procedure:

1. Type the Wireless SSID/ESSID address (172.28.120.1) of the projector in the address bar of the web browser. (Please find the SSID/ESSID address from the Network information in the OSD.)

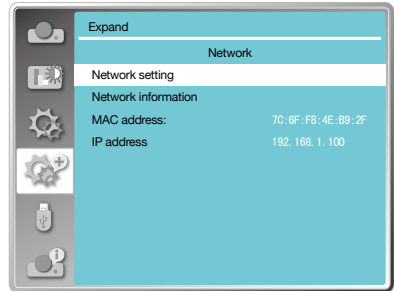

2. Click download button.

3. pwPresenter software: After entering the IP address of the projector in the web page to the main interface, click "Download", and download the corresponding PwPresenter software with your projector.

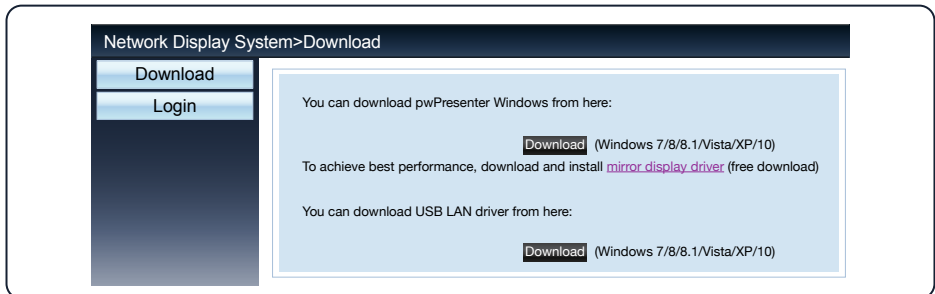
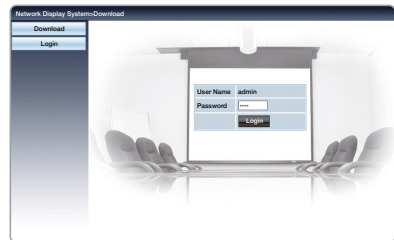

4. Click  the icon to enter into pwPresenter software. (Details about pwPresenter operation, please turn to page 80-82).



Click to enter to search, select the needed projector and connect it, set the same IP address (for example: 172.28.120.1) as the projector in pwPresenter software, and set user name as "admin", and the password is "admin".

Note

- Before using the pwPresenter search, please switch to the input signal of network.

Enter through a web browser

1. Start the computer's web browser.
2. Enter the IP address on the projector set in the URL input field of the Web browser.
3. Enter the password in the [Password].
 - The factory default setting is the user name: "admin" (administrator privileges), password: "admin".
4. Click the [Login]

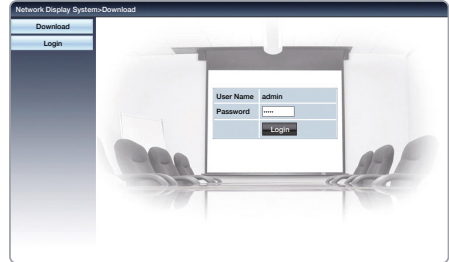

Note

Users can click on the top right corner of the web browser screen to select the display language.

Do not start multiple web browser settings or control. Do not use more than one computer to control the projector.

Please change your password.

If the network does not appear on screen controls, please consult your network administrator.

Description of each option

The diagram shows a navigation menu on the left with five items: System Status (1), General Setup (2), Picture Setup (3), Image Setup (4), and Network Setup (5). To the right is a screenshot of the 'System Status' page, which contains the following table:

Network Display System>System Status	
Model Name	Ruby
Versions	
Firmware Version	0.00.1003
LAN Status	
IP Address	192.168.0.65
Subnet	255.255.255.0
Gateway	192.168.0.1
Wire MAC Address	00:1e:c0:f2:11:e6

1 System status

Click this option to display the [System status] page.

2 General Setup

Click this option to display the [General Setup] page.

3 Picture Setup

Click this option to display the [Picture Setup] page.

4 Image Setup

Click this option to display the [Image Setup] page.

5 Network Setup

Click this option to display [Network Setup] page.

[System status] page

Network Display System>System Status	
System Status	Versions
General Setup	Firmware Version 0.00.1003
Picture Setup	LAN Status
Image Setup	IP Address 192.168.0.65
Network Setup	Subnet 255.255.255.0
	Gateway 192.168.0.1
	Wire MAC Address 00:1e:c0:f2:11:e6

1 Versions

Displays the firmware version of the projector.

2 LAN status

Displays the LAN connection status.

[General Setup] page

Network Display System>General Setup	
System Status	Change Password For Webpage
General Setup	Enter Old Password
Picture Setup	Enter New Password
Image Setup	Confirm New Password
Network Setup	Apply
	Power & Source
	Power On/Off
	Source Select HDMI 1

1 Enter old password

Enter the password for the configuration.

3 Confirm new password

Re-enter the new password to confirm.

5 Power

Switch on the power of the projector on / off.

2 Enter new password

Enter a new password.

4 Apply

Update settings.

6 Source select

Switch the input source of the projector.

[Picture setup] page

Network Display System>Picture Setup	
System Status	Brightness (0--63) 32
General Setup	Contrast (0--63) 32
Picture Setup	Sharpness (0--15) 8
Image Setup	Color (0--63) 0
Network Setup	Tint (0--63) 0
	Color Temperature
	Red (0--63) 32
	Green (0--63) 32
	Blue (0--63) 32

1 Brightness

Adjust the brightness of the projected image.

3 Sharpness

Adjust the sharpness of the projected image.

5 Tint

Adjusts the tint of the projected image.

2 Contrast

Adjust the contrast of the projected image.

4 Color

Adjusts colour saturation of the projected image.

6 Colour temperature

Adjust the colour temperature of the projected image.

[Image setup] page

The screenshot shows the 'Image Setup' menu with the following settings and callouts:

System Status	Aspect	Normal	1
General Setup	Fine sync (0-31)	0	2
Picture Setup	H Position	0	3
Image Setup	V Position	0	4
Network Setup	H Size	0	5
	Freeze	<input type="radio"/> On <input checked="" type="radio"/> Off	6
	Auto PC adj.	<input type="checkbox"/>	7
	V Keystone (-60--60)	0	8
	H Keystone (-30--30)	0	9
	Curved correction X Gain (-40--40)	0	10
	Curved correction Y Gain (-40--40)	0	
	Curved correction XOffset_x (-40--40)	0.0	
	Curved correction XOffset_y (-40--40)	0.0	
	Curved correction YOffset_x (-40--40)	0.0	
	Curved correction YOffset_y (-40--40)	0.0	
	Corner correction TopLeft_x (0--1279)	0	
	Corner correction TopLeft_y (0--799)	0	
	Corner correction TopRight_x (0--1279)	1279	
	Corner correction TopRight_y (0--799)	0	11
	Corner correction BottomLeft_x (0--1279)	0	
	Corner correction BottomLeft_y (0--799)	799	
	Corner correction BottomRight_x (0--1279)	1279	
	Corner correction BottomRight_y (0--799)	799	

1 Aspect ratio

Switch the aspect ratio of the projected image.

2 Fine sync

Adjust the phase of the projected image.

3 Horizontal position

Adjust the horizontal position of the projected image.

4 Vertical position

Adjust the vertical position of the projected image.

5 Horizontal dimension

Adjust the horizontal dimension of the projected image.

6 Screen freeze

Select the function to switch the screen freeze on and off.

7 Automatic computer adjustment

Implement the automatic computer adjustment function.

8 V Keystone

Correct trapezoidal distortion in vertical direction.

9 H Keystone

Correct horizontal distortion in horizontal direction.

10 Curved Correction

Correct pincushion and barrel of the projected image.

11 Corner correction

Correct four angles of the projected image.

[Network setup] page

Network Display System>Network Setup

System Status
General Setup
Picture Setup
Image Setup
Network Setup

LAN Setup

Obtain IP Address Automatically Use Following IP Address

IP Address	192	168	0	65
Subnet	255	255	255	0
Gateway	192	168	0	1
DNS	202	96	134	33

Apply

1 Network Setup

If you want to enable the DHCP client, select the IP address automatically.

IP address Please enter the IP address when you do not use the DHCP server.

Subnet Please enter a subnet shield, when you do not use the DHCP server.

Gateway Please enter the gateway, when you do not use the DHCP server.

DNS Please enter the DNS address, when you do not use the DHCP server.

- Available characters: Digital (0 - 9), a period (.) (for example: 192.168.0.253)

2 Apply
Update settings.

5. pwPresenter Software:

When the input signal source is chosen as the network, the network will be used to project computer image.

After entering the IP address of the projector in the web page to the main interface, click "download", and download the corresponding PwPresenter software with your projector.

Network Display System>Download

Download
Login

You can download pwPresenter Windows from here:

[Download](#) (Windows 7/8/8.1/Vista/XP/10)

To achieve best performance, download and install [mirror display driver](#) (free download)

You can download USB LAN driver from here:

[Download](#) (Windows 7/8/8.1/Vista/XP/10)

6. Click  the icon to enter into pwPresenter software.



1 Search network projector

Click to enter to search, select the needed projector and connect it . Set the same IP address (for example: 192.168.1.100) as the projector in pwPresenter software, and set user name as "admin", and the password is "admin".

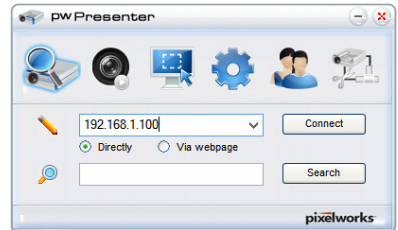

Note

- Before using the pwPresenter search, please switch to network signal source.

2 Screenshot start or pause

Start or pause the selected pictures.

3 Select screenshot mode.

Select screenshot mode from the "full range", "fixed size" or "variable size".

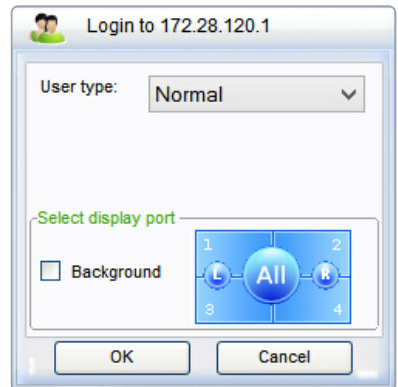

4 Parameter setting

Basic setting

language, capture region size, etc.

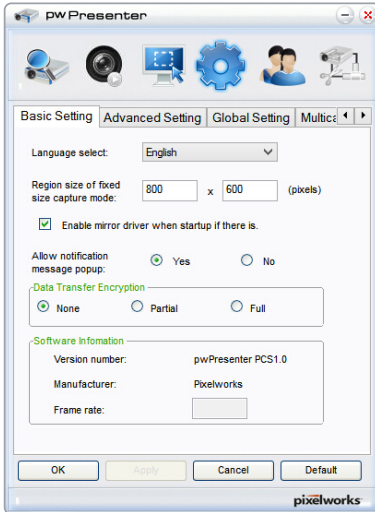

Advanced setting

JPEG image setting, network port setting, white list, and black list, etc.

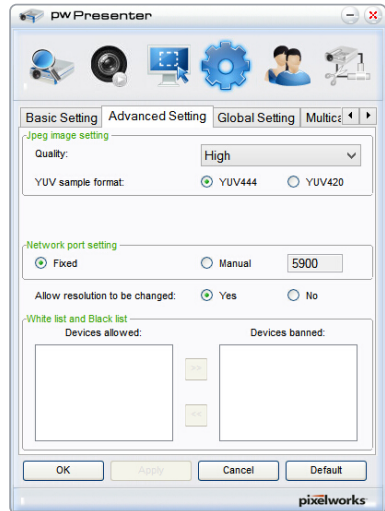

Global setting

Remote control setting, Sound capture and Screen capture, etc.

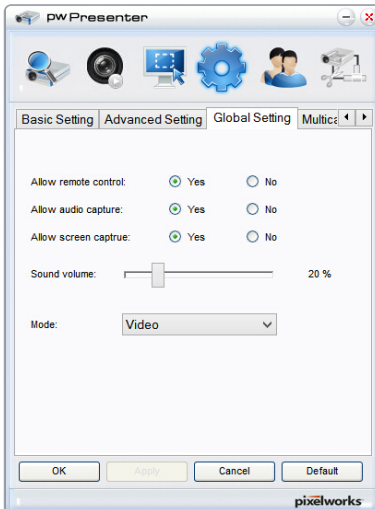

Multicast setting

Volume setting, Bandwidth, Sampling frequency, etc.

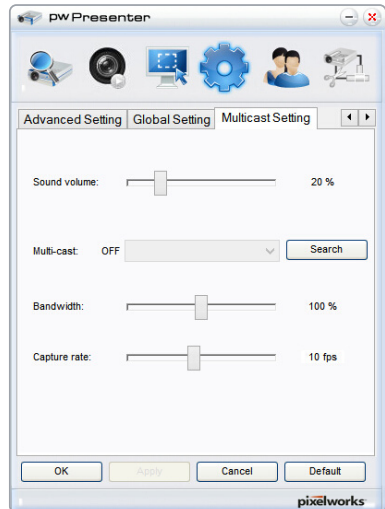

5 Network projector management

Set pwPresenter network user name and password, etc.

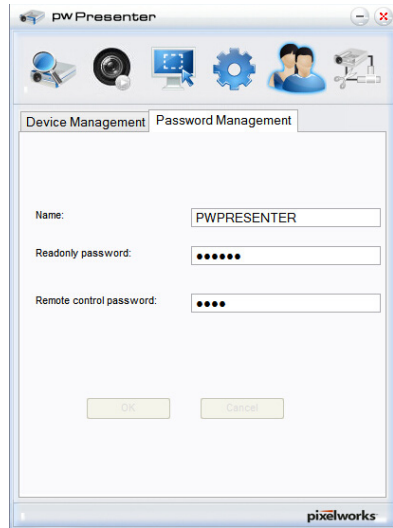
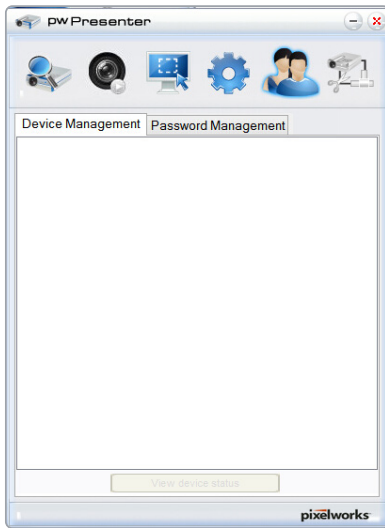

6 Cut off projector connection.

Memory Viewer function

When the USB memory is inserted into the projector, the viewer memory function can project the video and pictures stored in the USB memory.

The projected content of memory viewer function

Memory Viewer function supports the following picture files:

Video	Extension name	Video Codec	Audio Codec	Video Format
	avi	MotionJPEG	ADPCM	Maximum 1280x720, 30fps

Picture	Extension name	Format	Description
	jpg, jpeg	Baseline encoder 24	Max resolution: 10000x10000
		Progressive RGB24 bit	Max resolution: Panel Resolution
	bmp	1,4,8-bit palette-based RGB 24,32 bit	Max resolution: 1280x800
	png	24, 48-bit True Colour	24-Bit colour palette space Max resolution: 1024x768
	gif	1,4,8-bit palette-based	Max resolution: 800x600
	tiff		Max resolution: 800x600

Display memory viewer screen

When the USB memory is inserted into the projector, the viewer memory function can project the video and pictures stored in the USB memory.

1. Press INPUT button on the control panel and on the top control panel and select the input source of [Memory viewer].
2. Insert the USB memory into the <USB (browser) > terminal directly.
 - Press RC <OK> to display standby screen instantly / while the USB memory icon display in the left corner of the screen.
 - When the USB memory is independent of the partition, it will display more than one USB icon.
3. Press ▲▼ button to switch required items.
 - The root directory of the USB memory is displayed in a thumbnail.

Play image

Only one image show on the screen when you play it.

1. Press ▲▼ button to select a file.
2. Press <OK> or ► button.
 - Full screen display
3. Press <OK > button.
 - Press <OK> to return the thumbnail.

Play slide

The slide show mode in the memory viewer menu is set to a special setting, all images in the same folder can play automatically.

1. Press ▲▼ button to select a file.
2. Press ▲▼ button to select [Memory Viewer] menu, then select [From scratch] menu.
3. Press <OK > button.
 - Full screen display
 - Press <OK> button to return the thumbnail.

Play video

Play video files.

1. Press ▲▼ button to select a file.
2. Press <OK> button.
 - Full screen display
 - Use the remote control to operate the control that appears at the bottom of the screen.



	Stop playing the video and return to the thumbnail.
	Pause / play the video.
	Video fast forward / backward.
	Video fast forward / backward at the twice speed.
	Each time press the icon, the box switches. When the box appears, the video can playback.

The termination of Memory Viewer

1. Press ▲▼ button to select , displayed in the left corner of the screen.
2. Press <OK > button.
3. Unplug the USB memory directly.



Note

- When you insert a USB memory, please make sure insertion direction to avoid damaging the port.
- Please note the following points when inserting and removing USB memory:
 - a. The indicator flashes, when the USB memory insert into the projector or the projector is reading data, do not remove the USB memory When the light is flashing.
 - b. If you use a USB memory device without lights, the projector will not recognize when reading data. Please close its browse function on and turn off the projector, then remove the USB memory.
 - c. Do not install and remove USB memory frequently. Then remove it after the installation of at least 5 seconds. After removing at least five seconds and then reinstall it. The projector is on switch mode during the operation when installing or removing the USB memory.

Precautions on processing and storage of USB memory

- Please do not place the USB memory or the lid where children can reach. Swallow USB memory or the lid may cause choking.
- If smoke or produce abnormal smell, close the external device and contact the dealer.
- Do not let the water, chemicals or oil into the USB memory, or it may cause a short circuit or fire.
- Do NOT put foreign matter or metal items in the USB port. Static electricity may cause data loss or data damage.
- When USB memory is read or written, Do not remove USB memory from the computer or projector /otherwise it may result in data loss or corruption of data.
- Please do not put the USB memory in high temperature, damp or dusty place, or next to magnetic materials.



Note

- Insertion or removal of the USB memory may be performed when the projector is in any power status.

USB display function

Select this function to can project the image and audio from the computer through the USB converter cable.

When using Windows:

Windows operating environment

Operating System	Windows Vista, 7, 8, 10. 32bit and 64bit
CPU	Intel Core 2 Duo 2.0 GHZ or faster compatible processors
Memory Capacity	256MB or above (512MB or above)
Disk Space Available	20MB or above
Monitor	Resolution 640x480 and above



CAN NOT guarantee that the PC meeting the above conditions can operate normally.

Project USB display

- Using USB-B cable to connect the projector to the USB display terminals.
 - Items in grey are not available.
- Press the information source menu on the remote control or the input button on the control panel, then select [USB display] in the input source menu.
- Press the driver icon in the computer's task bar , the select one item in the pop-up menu bar.
 - Pop-up menu only anglais

[Active audio] / [Disable audio]	Sets up the output from the computer's audio
[Play video] / [Pause video]	Switch on playing and pausing images
[Start / Stop]	Sets up the output from the computer's image
[Exit]	Exit USB Display



- Note
- Resolution of the computer screen will be switched.
 - If the driver is not installed on the computer, the driver will be removed when the USB cable is disconnected.
 - You need wait for a moment, if you want project computer screen.
 - Connect the USB cable directly to the computer's USB connector. When connecting the USB hub, it may be abnormal.

The termination of USB display

- Remove the USB cable directly,when terminate USB monitor.
 - You never need follow "Remove Hardware Safel", when USB cable is not connected.

When using Mac OS:

Mac OS operating environment

Operating System	Mac OS x 10.5 and higher
CPU	Power PC G4 1GHz or faster compatible processors
Memory Capacity	512MB or above
Disk Space Available	20MB or above
Monitor	Resolution 640x480 and above



CAN NOT guarantee that the PC meeting the above conditions can operate normally.

Project USB display

- Using USB-B cable to connect the projector to the USB display terminals.
- Press the information source menu on the remote control or the input button on the control panel, then select [USB Monitor] in the input source menu.
- Double-click "monitor.app" button installed on the virtual disk.
 - Project image on the computer screen.
- Press the driver icon  in the dock of computer and select one item in the pop-up menu bar.
 - Pop-up menu only display in English.
 - Items in grey are not available.

[Active audio] / [Disable audio]	Sets up the output from the computer's audio.
[Play video] / [Pause video]	Switch on playing and pausing images.
[Start / Stop]	Sets up the output from the computer's image.
[Exit]	Terminate USB Monitor



- Note
- Resolution of the computer screen will be switched.
 - You need wait for a moment, if you want project computer screen.
 - Connect the USB cable directly to the computer's USB connector. When connecting the USB hub, it may be abnormal.

The termination of USB display

- Remove the USB cable directly,when terminate USB monitor.
 - You never need follow "Remove Hardware Safely, when USB cable is not connected.

WARNING light indicator

The WARNING light indicator shows status of projector protection function. Check WARNING and POWER light indicator for good maintenance operation.

The projector turns off and the WARNING indicator flashes red

Your projector powers off automatically to protect components within it when it is overheated. The POWER indicator flashes when your projector is cooling down. Press the POWER button to power your projector on again when it is cooled down to normal operation temperature.

Check the following:

- Is adequate clearance provided for your projector's ventilation? Check the installation status and any air outlet block.
- Is your projector installed at location close to outlet of air conditioning equipment? Keep your projector away from air outlet of air conditioning equipment.
- Is the filter in clean condition? Please clean the filter regularly.

The power is abnormal and the power indicator turns steady yellow

The power indicator turns steady yellow and your projector powers off to protect its internal components whenever an abnormality is detected. Unplug the AC power cord and connect again. Restart your projector and run check-up routine. If the problem persists, unplug the AC power cord and call your service centre for check-up and maintenance.



Note

Unplug the AC power cord in case of any abnormality as it may lead to fire or electric shock.

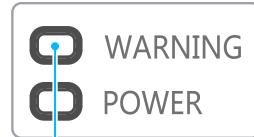

The WARNING indicator flashing red



Note

The POWER indicator stops flashing when your projector's internal temperature has cooled down to normal and it is powered on again.

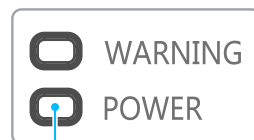

The POWER indicator turns steady yellow

Maintenance and cleaning

Clean your projector only using the below guidelines.

Clean the lens

Wipe the lens with clean cloth dampened with non-abrasive camera lens cleaner or clean it with lens cleaning paper or compressed air.

Do not over apply cleaner to the lens. Abrasive cleaner, solution, or other rough chemical may scratch the lens.

Clean casing of your projector

Wipe the casing surface with clean and soft cloth. Gently wipe the casing with clean and soft cloth dampened to remove heavy dirt. Do not over apply cleaner, abrasive cleaner, solution, or other rough chemical that may scratch the casing surface.

Place your projector in proper container after use to protect it from dirt and dust and being scratched.

Clear the filter

The filter is designed to keep dust from entering in your projector, which may lead to dusts accumulated on surface of internal components. Clogged filter may reduce cooling fan effects, which, in turn, will overheat your projector and shorten its life cycle. Clean the filter immediately whenever the Filter Warning icon displays.

Please follow these steps to clean your filter:

1. Power off your projector and unplug from AC power source.
2. Remove the filter.
3. Gently clean it with a brush.
4. Replace the filter. Make sure it has been fully inserted.

Note

Unplug the AC power cord before any cleaning operation.

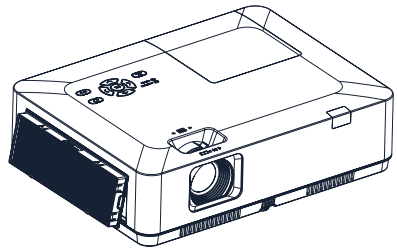
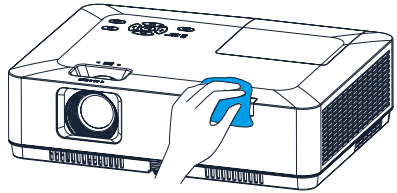
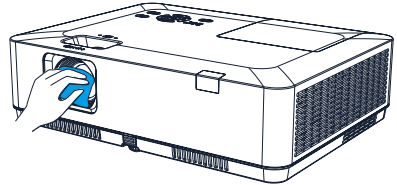

Note

Do not operate your projector after its filter is removed. Dust may attach to the lens assembly and deteriorate image quality.

Do not allow objects to enter the air outlets. Allowing objects to enter the projector will cause the projector to fail.

Reset the filter counter

1. Press MENU button and the OSD displays. Press ▲▼ button to select Expand menu, press ► button or OK.
2. Press ▲▼ button to select "Filter Counter", press ► button or OK. Press ▲▼ button to select "Filter counter reset" and press OK. The "Reset filter counter?" message displays. Select Yes to proceed.
3. In another pop-up dialogue box, select Yes to reset the filter counter.

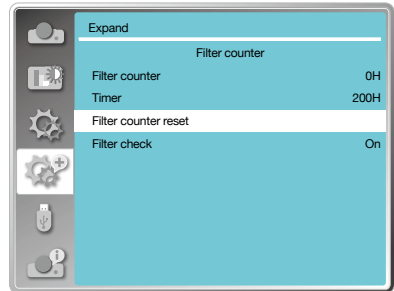

Recommendations

Please do not use your projector at place of dust and smoke. This may affects image quality. Using your projector in place of dust and smoke may lead to piling dusts on lens, LCD panel, and lens components within it. In case like this, call your dealer or service centre for correct cleaning.

Lamp replacement

The lamp warning icon displays when its usage time are more than the life of the projector minus 300H and less than the life of the projector.

The lamp replacement icon displays when its usage time are more than the life of the projector.

Lamp model

Your projector's lamp is a consumable. You can confirm your usage time according to "Light source counter" on the Info. menu in page 73.

You'd better ask a professional technician to replace the lamp. contact your dealer for help.

Please call your dealer to replace the lamp.

Recommendations

DO NOT replace the lamp when it is so hot. Make sure to replace it at least 1 hour later after using it.

The internal cover of lamp model is getting hot in use. Take care, or you may get burned.



Note

Reset the filter counter after its cleaning or replacement.

The lamp warning icon



The lamp replacement icon

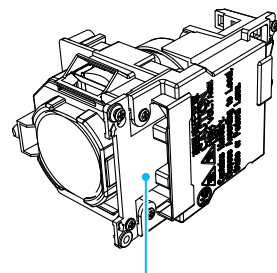
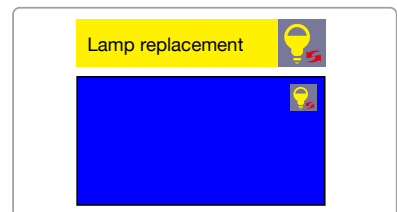

The lamp model



Note

Do not replace the lamp after it went dark as it may be broken. Always assume the lamp of a ceiling mounted your projector is broken when replacing it. Stand beside the lamp cover instead of below it. Remove the lamp cover gently. Small piece of glass debris may fall out when opening the lamp cover. Consult with a doctor immediately if there is any glass debris fell in your eyes or mouth.



Note

Let your projector cool for at least 45 minutes before opening the lamp cover, as temperature within your projector is high.



Note

Replace the lamp with a new one of the same model just in case. Do not drop or touch the lamp! It may break and lead to personal injuries.

Follow steps below to replace the lamp:

1. Power off your projector and unplug the AC power cord. Let it cool down for at least 45 minutes.
2. Open the lamp cover after removing screws holding the cover.
3. Loose all 3 screws fixing the lamp. Remove the lamp by holding its handle.
4. Replace with a new lamp and tighten all 3 screws. Make sure the lamp has been installed correctly. Close the lamp cover and tighten the screw.
5. Connect your projector to an AC power source and power it on.

Handle

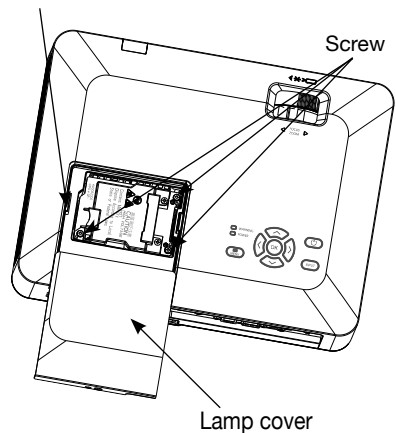

Note

Always use original manufactures lamps to ensure your projector is no damaged and operates according to design.



Precautions on lamp operation

Your projector employs high voltage lamp, which requires careful and correct operation.

Fail to do so may lead to accidents, personal injuries, or fire.

- Life cycle of lamp varies with environment it is in service. Life cycle of lamp varies. That is, some lamps may last longer than their counterparts.
- If your projector prompts you to replace lamp (by showing a lamp replacing icon) then replace it with a new one after powering it off and it is fully cooled down. (Please replace lamp by strictly following steps given in this manual.) If you keep on using the lamp after being prompted to replace it then you are exposed to greater risks of lamp explosion.
- Lamp may explode due to external impact and shock. Risks of explosion vary with projector and use environment and status of the lamp.

In case of lamp explosion, take the following safety measures:

Disconnect your projector from power source immediately in case of lamp explosion. Call authorized service centre to inspect your projector and replace lamp. Make a thorough inspection to ensure every piece of debris after explosion has been removed. Remove every piece of debris after explosion. No one else may inspect the internal of your projector except those authorized and well trained technician who also are familiar with its maintenance. Or we shall not be held liable for the consequences.

Troubleshooting

Check the following before calling your dealer or service centre:

Troubleshooting	Solution
Power on failure	<ul style="list-style-type: none"> • Plug the power cord of your projector in an AC socket. • Make sure the POWER light indicator turns red. • Restart your projector until the POWER light indicator turns red. It indicates your projector is ready for power on again. • Check the lamp. • Disable the Key Lock function of your projector.
Logo screen display failure	<ul style="list-style-type: none"> • Make sure the Off and Countdown Off is selected in the Display function.
The Logo screen differs from the standard settings	<ul style="list-style-type: none"> • Make sure you did not select User or Off in the Logo Screen.
Input signal switch (or do not switch) automatically	<ul style="list-style-type: none"> • Make sure you have correctly set up the Input Search function.
Press INPUT button during power on and a non-input mode icon displays	<ul style="list-style-type: none"> • This is a filter or lamp replacement alerts.
A non-input or lamp mode icon displays	<ul style="list-style-type: none"> • This is a filter replacement alerts.
Image looks fuzzy	<ul style="list-style-type: none"> • Adjust focus of your projector. • Provide proper projection distance. • The projection lens requires cleaning. • Moving your projector from a colder environment to a hotter one may result in condensing on the lens. If this is the case, wait until the condensing water evaporated before powering on your projector.
Image mirror reflected	<ul style="list-style-type: none"> • Check the Ceiling/Rear settings.
Image turns upside down	<ul style="list-style-type: none"> • Check the Ceiling settings.

Troubleshooting	Solution
Image looks dim	<ul style="list-style-type: none"> • Check for contrast and brightness settings. • Check for correct image mode settings • Check for lamp brightness settings. • Check for lamp replacement alert. The lamp replacement alert suggests the lamp is reaching the end of its life cycle. Please replace it with a new one of the same model immediately.
No image displays	<ul style="list-style-type: none"> • Check for the connection between your projector and computer or image equipment. • Check for correct input signal from computer. Connection with certain notebook computer may mandate changes to its display output settings. See the user manual included with the computer for details on settings. • It takes about 30 seconds for your projector to show the first image. • Check for mode of signal, colour system, image system, or computer system. • Make sure the ambient temperature is within given range [0°C–40°C (35-ECO)]. • Image does not display in BLANK mode. The BLANK button or other buttons on the remote control.
Abnormal colour	<ul style="list-style-type: none"> • Check for mode of signal, colour system, image system, or computer system. • Make sure Blackboard mode is not selected in Image mode.
Some operations are invisible	<ul style="list-style-type: none"> • Check the display function.
Auto PC Adjusting function failure	<ul style="list-style-type: none"> • Check input signal. Auto PC Adjusting function in unavailable in 480p, 576p, 720p, 480i, 576i or 1080i mode.
Settings do not save after power off	<ul style="list-style-type: none"> • Make sure you have selected Store after settings adjustment. Certain settings do not keep without selecting Store.
Power management failure	<ul style="list-style-type: none"> • In case of Freeze or Blank operation, the power management function does not work.
Auto Setting does not work	<ul style="list-style-type: none"> • Make sure it is not set to "Off" in each Setting menu. • Make sure "On" is not set in Ceiling function.
Image distorted or disappeared	<ul style="list-style-type: none"> • Check and revise the PC Adj. menu or Display.

Troubleshooting	Solution
A password prompt displays after power on	<ul style="list-style-type: none"> You have set up the Logo PIN Code lock function.
Remote control does not work	<ul style="list-style-type: none"> Check the battery. Make sure there is no obstacles stand in between your projector and the remote control. Make sure the remote control is not too far away from your projector. The maximum operation range is 8m. Make sure the remote control and your projector are paired with the same remote control codes. Disable the key lock of the remote control in the Setting menu.
Light indicator turns on or flashes	<ul style="list-style-type: none"> Check status of your projector according to the light indicator status.
"X" mark displays	<ul style="list-style-type: none"> Invalid operation, please operate your projector correctly.
Control panel does not function	<ul style="list-style-type: none"> Disable the key lock on control panel function in the Key lock option of the Setting menu.
Cannot remove the Logo Select password, Key Lock, and PIN Code lock	<ul style="list-style-type: none"> Please call your dealer or service centre.

- Make sure your projector is correctly connected to external equipment.
- Make sure all devices are plugged in an AC power source and have been powered on.
- If your projector fails to project image of the connected computer, restart the computer.

 **Note**

Your projector employs high voltage power for operation. Do not open its casing. If the problem persists, call your dealer or service centre. Along with model number of your projector and a description to your problem.

Menu tree

Main menu	Sub-menu	Setting	Remarks
Display	Auto PC adj.		
	Fine sync	0 - 31	
	H position	-5 - +5	
	V position	-5 - +5	
	H.Size	-15 - +15	The range of H.Size differs from signals.
	Aspect	Normal Wide Advanced Full	
	Project way	Front Rear Ceiling/Front Ceiling/Rear Auto Ceiling/Front Auto Ceiling/Rear	
	Menu position	Upper left, Upper right Centre Lower left, Lower right	
	Background display	Black Blue	
	System	Auto PAL SECAM NTSC NTSC4.43 PAL-M PAL-N PAL-60	Video input
Colour adj.	Image mode	Dynamic Standard Cinema Blackboard (Green) Colourboard User image	
	Contrast	0-63	PC input
	Brightness	0-63	
	Colour temp	High, Mid, Low	
	Red	0-63	
	Green	0-63	
	Blue	0-63	
Sharpness	0-15		

Main menu	Sub-menu	Setting	Remarks	
Colour adj.	Contrast	0-63	Video input	
	Brightness	0-63		
	Colour	0-63		
	Tint	0-63		
	Red	0-63		
	Green	0-63		
	Blue	0-63		
	Sharpness	0-15		
Setting	Direct power on	On, Off		
	Standby mode	Normal, ECO		
	High land	On, Off		
	Light source mode	Normal, ECO		
	Cooling fast	Normal, 60 Sec, 0 Sec		
	Closed caption	Off, CC1, CC2, CC3, CC4		
	Key lock	Off, projector, remote control		
	Iris	On, Off		
	Sound	Volume	0-25	
		Mute	On, Off	
	HDMI Setup	Image	64-940	
			0-1023	
Sound		HDMI		
		VGA		
HDMI EQ Setup	0-3			
Expand	Language	Projector provides multiple language support		
	Auto setup	Input Search	On, Off	
		Auto PC adj.	On, Off	
		Auto keystone	Off, Auto, Manual	
	Keystone	Keystone	Store, Reset	
		H/V Keystone		
		4-Corner correction		
		6-Conner correction		For WUXGA series
		Curved correction		
		Grid image tune		
	Reset value			
	Logo	Logo select	Default, User, Off	
		Capture		
		Logo PIN code lock	On, Off	
Logo PIN Code Change				

Main menu	Sub-menu	Setting	Remarks
Expand	Security	PIN code lock	On, Off
		PIN code change	
	Power management	Ready Shut down Off Timer Ready countdown	
		Filter counter	Filter counter Timer Filter counter reset
	Filter check		On, Off
	Test pattern	Off, Gray scale (1-4), Colour bar, Red, Green, Blue, Cross hatch, White, Black, Raster grey	
	Network	Network setting	LAN DHCP(On/Off) IP address Subnet Gateway DNS
	Factory default		
Memory Viewer	Set slide		
	Slide transition effect	Slide down Slide right	
	Sort order	Extend order Size order Time order Name order	
	Rotate	No rotate 270° Degree 180° Degree 90° Degree	
	Best fit	On, Off	
	Repeat	On, Off	
	Apply		
Info.	Input		
	H-sync. freq.		
	V-sync. freq.		
	Light source counter		
	Power management		
	Image mode		

Main menu	Sub-menu	Setting	Remarks
Info	Model Name		
	S/N		
	Firmware Version		

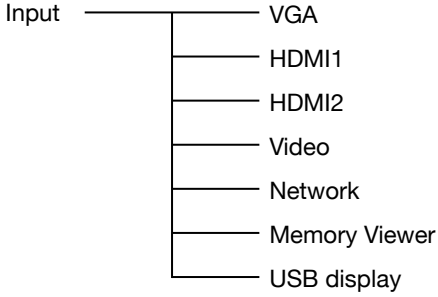

Light indicator status

Check light indicator to learn status of your projector.

Light indicator		State of your projector
WARNING (Red)	POWER (Red / Green / Yellow)	
		Your projector is in Off status (without AC power supply).
		Your projector is in standby status. Press Power button to turn it on.
		Your projector is in normal status.
		It is in ready status or the light source is cooling.
		Your projector is in Ready mode.
		Your projector detects the voltage abnormality and switches into standby mode.
		Your projector detects the FAN abnormality and switches into cooling mode.
		Your projector detects the temperature abnormality and switches into cooling mode.
		Your projector detects the temperature abnormality and switches into standby mode.
		Your projector detects the light source abnormality and switches into cooling mode.
		Your projector detects the light source abnormality and switches into standby mode.
		Your projector detects its usage time \geq the life of the projector and < 1.1 times of the life of the projector.
		Your projector detects its usage time ≥ 1.1 times of the life of the projector.

...Green

...Red

...Yellow

...Turns off

...Flashing green

...Flashing red

...Flashing yellow

Compatible computer screen

Your projector is designed to accept every computer signal below Dot Clock 160MHz. See table below for details on resolution and relevant frequency.

No	OSD Display	Source			Specification			
		RGB	HDMI	Video	Resolution	Pixel clock (MHz)	H-freq (KHz)	V-freq (Hz)
1	NTSC	—	—	○	NTSC	—	15.734	59.940
	NTSC-443	—	—	○	NTSC 4.43			
	PAL-60	—	—	○	PAL60			
	PAL-M	—	—	○	PAL-M			
2	PAL	—	—	○	PAL	—	15.625	50.000
	PAL-N	—	—	○	PAL-N			
	SECAM	—	—	○	SECAM			
3	720x480i, 60Hz	○	—	—	720x480i	13.500	15.734	59.940
4	720x480i, 60Hz	—	○	—	720(1440)x480i	27.000	15.734	59.940
5	720x576i, 50Hz	○	—	—	720x576i	13.500	15.625	50.000
6	720x576i, 50Hz	—	○	—	720(1440)x576i	27.000	15.625	50.000
7	720x483, 60Hz	○	○	—	720x483(480P)	27.000	31.469	59.940
8	720x576, 50Hz	○	○	—	720x576(576P)	27.000	31.250	50.000
9	1280x720p, 60Hz	○	○	—	1280x720p	74.250	45.000	60.000
		○	○	—		74.176	44.955	59.940
10	1280x720p, 50Hz	○	○	—		74.250	44.955	50.000
11	1920x1080i, 60Hz	○	○	—	1920x1080i	74.250	33.750	60.000
		○	○	—		74.176	33.716	59.940
12	1920x1080i, 50Hz	○	○	—		74.250	28.125	50.000
13	1920x1080p 24Hz	—	○	—	1920x1080p	74.250	27.000	24.000
		○	○	—		74.176	26.970	23.980
14	1920x1080p 60Hz	○	○	—	1920x1080p	148.500	67.500	60.000
		○	○	—		148.352	67.433	59.940
15	1920x1080p 50Hz	○	○	—		148.500	56.250	50.000
16	640x480, 60Hz	○	○	—	640x480	25.175	31.469	59.940
17	640x480, 67Hz	○	○	—		30.240	35.000	66.667
18	640x480, 72Hz	○	○	—		31.500	37.861	72.809
19	640x480, 75Hz	○	○	—		31.500	37.500	75.000
20	640x480, 85Hz	○	○	—		36.000	43.269	85.008

No	OSD Display	Source			Specification			
		RGB	HDMI	Video	Resolution	Pixel clock (MHz)	H-freq (KHz)	V-freq (Hz)
21	800x600, 56Hz	○	○	—	800x600	36.000	35.156	56.250
22	800x600, 60Hz	○	○	—		40.000	37.879	60.317
23	800x600, 72Hz	○	○	—		50.000	48.077	72.188
24	800x600, 75Hz	○	○	—		49.500	46.875	75.000
25	800x600, 85Hz	○	○	—		56.250	53.674	85.061
26	832x624, 75Hz	○	○	—	832x624	57.283	49.725	74.550
27	1024x768, 60Hz	○	○	—	1024x768	65.000	48.363	60.004
28	1024x768, 70Hz	○	○	—		75.000	56.476	70.069
29	1024x768, 75Hz	○	○	—		78.750	60.023	75.029
30	1024x768, 85Hz	○	○	—		94.500	68.678	84.997
31	1152x864,70Hz	○	○	—	1152x864	94.200	63.995	70.020
32	1152x864,75Hz	○	○	—		108.000	67.500	75.000
33	1280x720,60Hz	○	○	—	1280x720	74.500	44.772	59.855
34	1280x768, 60Hz	○	○	—	1280x768	79.500	47.776	59.870
35	1280x768, 75Hz	○	○	—		102.250	60.289	74.893
36	1280x768, 85Hz	○	○	—		117.500	68.630	84.840
37	1280x800, 60Hz	○	○	—	1280x800	83.500	49.702	59.810
38	1280x800, 75Hz	○	○	—		106.500	62.795	74.934
39	1280x800, 85Hz	○	○	—		122.500	71.554	84.880
40	1280x960, 60Hz	○	○	—	1280x960	108.000	60.000	60.000
41	1280*960, 75Hz	○	○	—		126.000	75.000	75.080
42	1280x1024, 60Hz	○	○	—	1280x1024	108.000	63.981	60.020
43	1280*1024, 65Hz	○	○	—		118.500		65.180
44	1280x1024, 72Hz	○	○	—		135.060	78.16	71.97
45	1280x1024, 75Hz	○	○	—		135.000	79.976	75.025
46	1280x1024, 85Hz	○	○	—		157.500	91.146	85.024
47	1360*768, 60Hz	○	○	—	1360x768	85.500	47.710	60.020
48	1366x768, 60Hz	○	○	—	1366x768	84.750	47.720	59.799
49	1400x1050, 60Hz	○	○	—	1400x1050	121.750	65.317	59.978
50	1400x1050, 75Hz	○	○	—		156.000	82.278	74.867
51	1440x900, 60Hz	○	○	—	1440x900	106.500	55.935	59.887
52	1600x900, 60Hz	○	○	—	1600x900	118.998	55.920	60.000

No	OSD Display	Source			Specification			
		RGB	HDMI	Video	Resolution	Pixel clock (MHz)	H-freq (KHz)	V-freq (Hz)
53	1600x1200, 60Hz	○	○	—	1600x1200	162.000	75.000	60.000
54	1680x1050, 60Hz	○	○	—	1680x1050	146.250	65.290	59.954
55	1920x1080, 60Hz	○	○	—	1920x1080	138.500	66.587	59.934
56	1920x1200, 60Hz	○	○	—	1920x1200	154.000	74.038	59.950
57	3840x2160, 30Hz	—	○	—	3840x2160	297.000	67.500	30.000

“○” shows input signal source support this format.

“—” shows input signal source do not support.



Note

Changes to this manual may be made without notice.

Terminal configuration

VGA IN / MONITOR OUT Terminal (D-sub 15)				
	1	Red (Input, output)	9	-----
	2	Green (Input, output)	10	Grounding (field synchronizing)
	3	Blue (Input, output)	11	Grounding
	4	-----	12	DDC data
	5	Grounding (line synchronizing)	13	Horizontal synchronizing (compound sync.) input/output
	6	Grounding (red)	14	Vertical synchronizing input/output
	7	Grounding (green)	15	DDC Clock
	8	Grounding (blue)		
SERIAL Terminal (D-SUB 9)				
	1	-----	6	-----
	2	RXD	7	-----
	3	TXD	8	-----
	4	-----	9	-----
	5	GND		

LAN Terminal



1	TX +	5	-----
2	TX -	6	RX -
3	RX +	7	-----
4	-----	8	-----

HDMI Terminal (HDMI Type A 19)

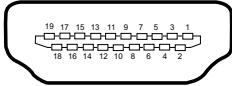

1	TMDS Data2+	11	TMDS Clock Shield
2	TMDS Data2 Shield	12	TMDS Clock-
3	TMDS Data2-	13	CEC
4	TMDS Data1+	14	Reserved (N.C. on device)
5	TMDS Data1 Shield	15	SCL
6	TMDS Data1-	16	SDA
7	TMDS Data0+	17	DDC/CEC Ground
8	TMDS Data0 Shield	18	+5V Power
9	TMDS Data0-	19	Hot Plug Detect
10	TMDS Clock+		

Dimensions

(For IN1029, IN1039, IN1049, IN1059, IN1024, IN1034, IN1044, IN1026, IN1036, IN1046)

Support frame for Ceiling Mount

Screw: M4

Depth: 10.0

Unit: mm

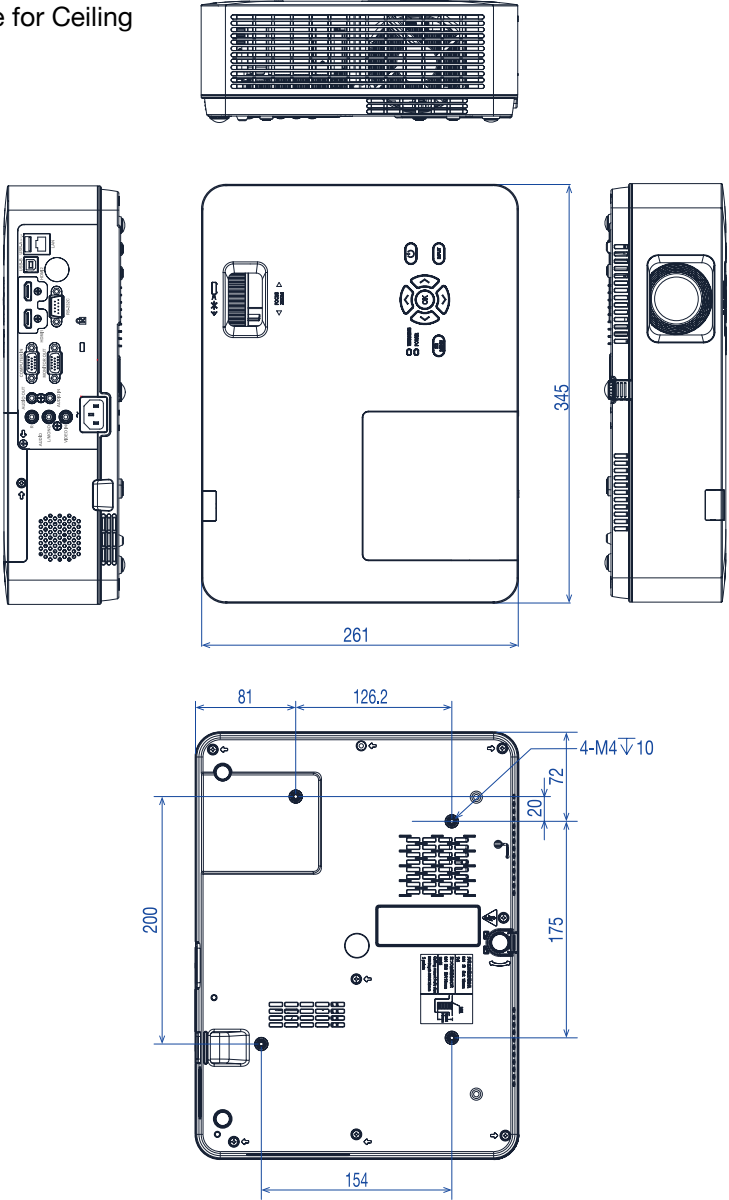

Dimensions

(For IN1004, IN1014)

Support frame for Ceiling Mount

Screw: M4

Depth: 10.0

Unit: mm

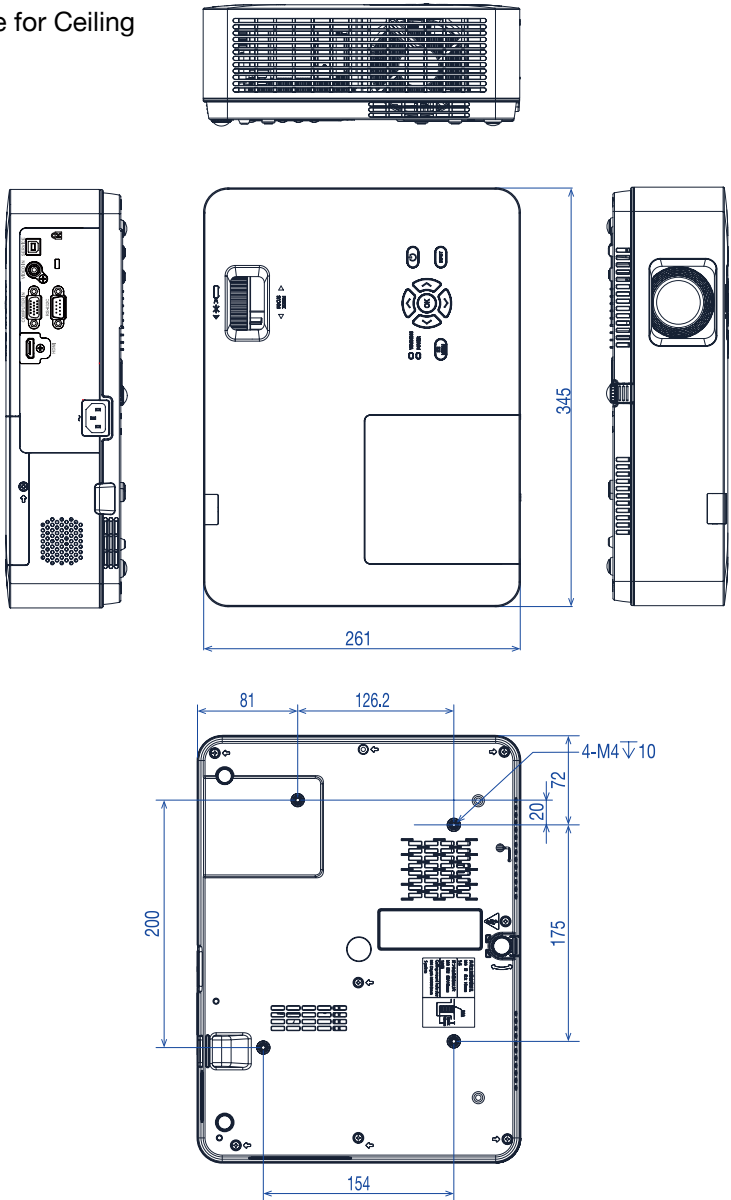

Technical Specifications

LightPro Advanced LCD	IN1004	IN1014	IN1024	IN1034	IN1044	IN1026	IN1036	IN1046	IN1029	IN1039	IN1049	IN1059
IMAGE												
Projection Technology	LCD with Micro-Lens Array											
Panel Size	3 x SonyTM 0.63"					3 x SonyTM 0.59"			3 x SonyTM 0.64"			
Native Resolution	XGA					WXGA			WUXGA			
Pixels	1024 x 756					1280 x 800			1920 x 1200			
Aspect Ratio	4:3					16:10			16:10			
Contrast Ratio	2000:1		50000:1 with Iris									
Brightness (Lumens)	3100	3400	4000	4800	4800	4200	4600	4600	4200	4200	4600	4600
Light Source	UHP Lamp											
Light Source Life Maximum Hours	20000											
Maximum Supported Resolution	3840 x 2160 (4K) @ 30Hz											
Horizontal Sync. Range (KHz)	15 ~ 100											
Vertical Sync. Range (Hz)	48 ~ 85											
Uniformity	85%											
OPTICAL												
Lens (Zoom)	1.2x			1.66x		1.2x		1.66x	1.2x	1.66x	1.2x	1.66x
Lens Zoom Adjustment	Manual											
Optional Lenses	-											
Image Offset (Percentage)	14					7	10					
Focal Length (mm)	19.11 ~ 22.94		19.16 ~ 23.02		17.50 ~ 29.01	19.16 ~ 23.02		17.50 ~ 29.01	19.16 ~ 23.02	17.50 ~ 29.01	19.16 ~ 23.02	17.50 ~ 29.01
F-Stop	2.1 ~ 2.25		1.6 ~ 1.76		1.7 ~ 2.1	1.6 ~ 1.76		1.7 ~ 2.1	1.6 ~ 1.76	1.7 ~ 2.1	1.6 ~ 1.76	1.7 ~ 2.1
Vertical Lens shift (%)	-											
Horizontal Lens shift	-											

LightPro Advanced LCD	IN1004	IN1014	IN1024	IN1034	IN1044	IN1026	IN1036	IN1046	IN1029	IN1039	IN1049	IN1059
Keystone Adjustment	Manual		Automatic / Manual									
Vertical Keystone correction	±30°											
Horizontal Keystone correction	-		±30°									
Projection Factor	1.48 ~ 1.78:1				1.34 ~ 2.22:1	1.48 ~ 1.78:1	1.37 ~ 1.65:1	1.26 ~ 2.09:1	1.37 ~ 1.65:1	1.26 ~ 2.09:1	1.37 ~ 1.65:1	1.26 ~ 2.09:1
Projection Distance [m]	0.88 ~ 10.90	0.89 ~ 10.94	0.81 ~ 13.86	0.94 ~ 11.60	0.87 ~ 10.74	0.81 ~ 13.86	0.87 ~ 10.74	0.81 ~ 13.86	0.87 ~ 10.74	0.81 ~ 13.86	0.87 ~ 10.74	0.81 ~ 13.86
Optical Zoom	Manual											
Digital Zoom Demagnification / Magnification	0.0x ~ 4.0x											
Focus Adjustment	Manual											
CONNECTIVITY												
Analog Input	VGA											
Analog Output	-		VGA									
Digital Input	HDMI™ 1.4 (HDCP 1.4), RJ45		2x HDMI™ 1.4 (HDCP 1.4), USB-B 2.0, RJ45									
Digital Output	-											
Audio Input	-		3.5 mm 2x RCA									
Audio Output	-		3.5 mm									
Control	RS232, RJ45		RS232, RJ45, USB-B 2.0									
Service	USB-B 2.0											
Powered USB for Wireless Dongle	USB-A 2.0 5V/1.5A/7.5W											
3D Sync	-											
Full 3D Support	-											
3D Formats	-											
Document Reader	-		USB-A 2.0 (PDF)									
Video Player	-		USB-A 2.0 (AVI)									
Photo Viewer	-		USB-A 2.0 (JPG, BMP, PNG, GIF, TIFF)									
Music Player	-		USB-A 2.0 (AVI)									
PC Less Compatibility	-											

LightPro Advanced LCD	IN1004	IN1014	IN1024	IN1034	IN1044	IN1026	IN1036	IN1046	IN1029	IN1039	IN1049	IN1059
POWER												
Power Supply	100 ~ 240 V AC; 50 - 60 Hz											
Power Consumption Max [W]	300	340										
Power Consumption Min. [W]	150											
Power Consumption Network Standby (W)	-	<2										
Power Consumption Standby (W)	<0.5											
GENERAL												
Dimensions (W x H x D) [mm]	345 x 261 x 99											
Weight [kg]	3,1	3,3										
Fan Noise [dB (A)]	26 ~ 32											
Audio (W)	-	1 x 16										
Operating Temperature [°C]	5 ~ 40											
Operating Humidity [%]	20 ~ 80											
Operating Altitude (meters)	0 ~ 3000											
Storage Temperature [°C]	-10 ~ 50											
Storage Humidity [%]	20 ~ 80											
Security	Kensington Lock Port, Security Bar, Keypad Lock, PIN & Timer Functions											
In the Box	Projector, IR Remote Control, Power Cord, VGA Cable, Setup Guide											
Safety and Regulatory	CB, CE, EAC, cTUVus, CCC, FCC, UKCA, NOM*, PSB, BIS											
Environmental	WEEE, EU RoHS, China RoHS, CEL, CECP											

- The aforesaid specification is subject to change without prior notice.
- Liquid crystal panel is made on the basis of high standard, where 99.99% of the pixels are effective.

Due to the nature of the liquid crystal panel, a fraction of the pixels (0.01% or less) may be ineffective.

RS232 control mode

1. Serial connection

1.1 Port setting

Project	Set point
Communication method	Asynchronous communication
Communication rate	19200
Length	8-bit
Parity check	NO
Stop position	1
Flow control	NO

1.2 Connection mode

Can only use RS232 serial cross connect PC and projector.

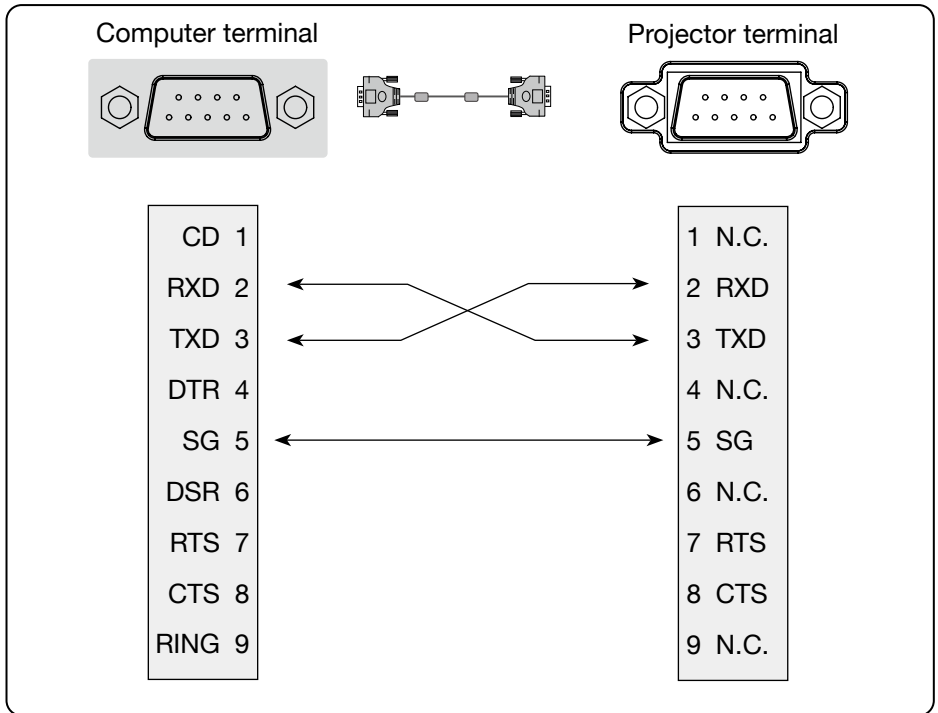

2. Basic commands

Distinguish the letter case, and enter Each command ends with [CR] (enter).

Command	Option	Command	Option
C00	POWER ON	C07	Video
C01	POWER OFF (immediately)	C15	NETWORK
C02	POWER OFF	C16	MEMORY VIEWER
C36	HDMI1	C17	USB DISPLAY
C37	HDMI2	C05	VGA

2.1 POWER ON command

Command	"C00" [CR]		
Details	Power ON action. Do nothing,when you are in Power ON state . Send this command can force the end of the countdown in the countdown state.		
Return value	Receive successfully	[ACK] [CR]	
	Receive unsuccessfully	" ? " [CR]	

2.2 POWER OFF command (Namely Power Off immediately)

Command	"C01"[CR]		
Details	Power off action. Send this command can force your projector to power off during in power on state.		
Return value	Receive successfully	[ACK] [CR]	
	Receive unsuccessfully	" ? " [CR]	

2.3 POWER OFF command

Command	"C02"[CR]		
Details	Power OFF action. A "POWER OFF" dialogue box pops up when sending the POWER OFF command ,and do once again can force your projector to power off. Send this command can force the end of the countdown in the countdown state.		
Return value	Receive successfully	[ACK] [CR]	
	Receive unsuccessfully	" ? " [CR]	

2.4 HDMI 1 command

Command	"C36" [CR]	
Details	Select HDMI input.	
Return value	Receive successfully	[ACK] [CR]
	Receive unsuccessfully	" ? " [CR]

2.5 VGA command

Command	"C06" [CR]	
Details	Select VGAIN input	
Return value	Receive successfully	[ACK] [CR]
	Receive unsuccessfully	" ? " [CR]

2.6 NETWORK command

Command	"C15" [CR]	
Details	Select NETWORK input	
Return value	Receive successfully	[ACK] [CR]
	Receive unsuccessfully	" ? " [CR]

2.7 MEMORY VIEWER command

Command	"C16" [CR]	
Details	Select MEMORY VIEWER input	
Return value	Receive successfully	[ACK] [CR]
	Receive unsuccessfully	" ? " [CR]

2.8 USB Display command

Command	"C17" [CR]	
Details	Select RGBHV input	
Return value	Receive successfully	[ACK] [CR]
	Receive unsuccessfully	" ? " [CR]

2.9 Video command

Command	"C07" [CR]	
Details	Select Video input	
Return value	Receive successfully	[ACK] [CR]
	Receive unsuccessfully	" ? " [CR]

2.10 HDMI 2 command

Command	"C37" [CR]	
Details	Select HDMI 2 input	
Return value	Receive successfully	[ACK] [CR]
	Receive unsuccessfully	" ? " [CR]

Contacting InFocus

InFocus technical support can be contacted at the below phone numbers within the stated operating hours, by using the enquiry form links provided or by visiting infocus.com and clicking on the chat support icon found on every page.

US & Canada
Mon-Fri | 6:00am - 5:00pm PST



United States
 877-388-8360



Canada
 877-388-8360

Technical support enquiry

Europe, Middle-East & Africa
Mon-Fri | 08:00 - 17:00 CET



Austria
 0800 4636287



France
 0800 905993



Germany
 0800 1813649



Italy
 0800 877238



Sweden
 020 791251



Spain
 0900 993163



Switzerland
 0800 04636287



UK & Northern Ireland
 0800 0286470



European Union
 +8000 463 6287

Technical support enquiry

Asia-Pacific region
Mon-Fri | 08:00 - 17:00 Local Time



Australia
☎ 1300-577-321



India
☎ 044-22252042
☎ 044-42015277/89

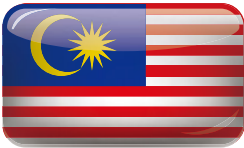

Malaysia
☎ +607-3535133
☎ +603-80708889



New Zealand
☎ 008000 463-6287



Singapore
☎ +65 93387857

Technical support enquiry

Restriction of use

When this product is used for applications requiring high reliability/safety, such as transportation devices related to aviation, rail, marine, automotive, disaster prevention devices; various safety devices, or functional/precision devices, you should use this product only after giving consideration to including fail-safes and redundancies into your design to maintain safety and total system reliability. Because this product was not intended for use in applications requiring extremely high reliability/safety, such as aerospace equipment, main communication equipment, nuclear power control equipment, or medical equipment related to direct medical care, etc., please make your own judgment on this product's suitability after a full evaluation.

Important Statement on Network Service

All contents and services obtained from the Product are owned by third parties and protected by copyright, patent, trademark and/or other intellectual property laws. These contents and services are only for your personal non-commercial purposes, which shall not be used in a way not authorised by the content owner or service provider.

Under no circumstance shall InFocus be liable for any direct, indirect or unexpected losses or damages arising from your or any third party's access to any contents or services or any information or third-party software through this Product.

Third-party services may be subject to change, removal or discontinuation without prior notice. InFocus does not represent or warrant that some services or contents will remain accessible at any time.

InFocus will not be responsible for any service related to these contents and services or assume any liability for customer service. For any question or service request about these contents and services, please directly contact the corresponding content or service provider.

Disposing of your used product In the European Union

EU-wide legislation as implemented in each Member State requires that used electrical and electronic products carrying the mark (below) must be disposed of separately from normal household waste. This includes projectors and their electrical accessories.

When you dispose of such products, please follow the guidance of your local authority and/or ask the shop where you purchased the product.

After collecting the used products, they are reused and recycled in a proper way. This effort will help us reduce the waste as well as the negative impact to the human health and the environment at the minimum level.

The mark on the electrical and electronic products only applies to the current European Union Member States.

The crossed-out wheeled bin implies that used batteries should not be put to the general household waste!

There is a separate collection system for used batteries, to allow proper treatment and recycling in accordance with legislation.

According to the EU directive 2006/66/EC, the batteries can't be disposed improperly. The battery shall be separated to collect by local service.

Disposing of your used product outside the European Union

If you wish to dispose of used electrical and electronic products outside the European union, please contact your local authority and ask for the correct method of disposal.

Californian residence

WARNING TO CALIFORNIA RESIDENTS:

Handling the cables supplied with this product will expose you to lead, a chemical known to the State of California to cause birth defects or other reproductive harm.

WASH HANDS AFTER HANDLING.

RF interference (for USA only)

Warning

The Federal Communications Commission does not allow any modifications or changes to the unit EXCEPT those specified by InFocus in this manual. Failure to comply with this government regulation could void your right to operate this equipment. This equipment has been tested and found to comply with the limits for a Class B digital device, pursuant to Part 15 of the FCC Rules. These limits are designed to provide reasonable protection against harmful interference in a residential installation. This equipment generates, uses, and can radiate radio frequency energy and, if not installed and used in accordance with the instructions, may cause harmful interference to radio communications. However, there is no guarantee that interference will not occur in a particular installation.

If this equipment does cause harmful interference to radio or television reception, which can be determined by turning the equipment off and on, the user is encouraged to try to correct the interference by one or more of the following measures:

- Reorient or relocate the receiving antenna.
- Increase the separation between the equipment and receiver.
- Connect the equipment into an outlet on a circuit different from that to which the receiver is connected.
- Consult the dealer or an experienced radio / TV technician for help.

Turkish RoHS information relevant for Turkish market

EEE Yönetmeliğine Uygundur.

This device is not intended for use in the direct field of view at visual display workplaces. To avoid incommoding reflections at visual display workplaces this device must not be placed in the direct field of view.

Lamps

US Residents

The lamp in this product contains mercury. Please dispose according to Local, State or Federal Laws.

Canadian Environmental Protection Act, 1999

The lamp(s) in this product contains mercury. Please dispose according to your local authority law.

Manufacturer, EU importer and EU Authorised Representative in accordance with EU directives

Manufacturer

Maxnerva Technology Services Limited

Room 1001, 10/F, Houston Centre, 63 Mody Road, Tsim Sha Tsui East, Kowloon, Hong Kong.

EU Importer

Grand Field Technology Limited

Room 1001, 10/F, Houston Centre, 63 Mody Road, Tsim Sha Tsui East, Kowloon, Hong Kong.

EU Authorised Representative

24Hour-AR

Storgatan 51, 903 26 Umeå, Sweden

T +46 (0)10-424 00 20

E info@24hour-ar.com

W www.24hour-ar.com

UK Authorised Representative in accordance with UK regulations

Independent Quality Solutions Ltd

Enterprise House, Wrest Park, Silsoe, Bedfordshire, MK45 4HR

T +44 (0)1462 713322

E enquiries@i-q-s.co.uk

W www.i-q-s.co.uk

Russian Authorised Representative

InFocus has appointed AUVIX LLC, 129085, c. Moscow, Zvezdny Boulevard, 21, bldg. 1. as the authorised representative in Russia and this product is compliant with TR TC 004/2011, TR TC 020/2011 and TR CU 020/2011 local conformity testing and approvals.

«InFocus назначил ООО « АУВИКС », 129085, г. Москва, Звездный бульвар, д. 21, стр. 1., в качестве официального представителя в России, и этот продукт соответствует требованиям TR TC 004/2011, TR TC 020/2011 и TR CU 020 / 2011г. местные испытания на соответствие и согласования»

ООО « АУВИКС »

129085, г. Москва, Звездный бульвар, д. 21, стр. 1

T +7 (495) 797-57-75

E-mail: info@auvix.ru

US Importer and Local Representative in accordance with FCC regulations

Maxnerva Technology Services USA LLC

13190 SW 68th Parkway, Suite 120

Portland, Oregon, 97223, USA

EU Declaration of Conformity

20210802-000
(1. document number)

2021/08
(2. Year, Month in which the CE mark is affixed)

We, **MAXNERVA TECHNOLOGY SERVICES LIMITED**
(3. company name & manufacturer)

Room 1001, 10/F Houston Centre 63 Mody Road, Tsim Sha Tsui East, Kowloon, Hong Kong
(4. address)

declare under our sole responsibility that the product(s):

P160
(5. the regulatory model)
IN1004, IN1014
(6. marketing references)
LCD Projector
(7. product type)
INFOCUS
(8. brand)

The designated product(s) is (are) in conformity with the essential requirements of the following European Directives and Regulations, by compliance with the European and International standards or other specifications as listed:

Directive 2014/30/EU of the Electromagnetic Compatibility (EMC) Directive (9. directive)

EN 55032:2015+A11:2020, CISPR 32:2015+A1:2019: Class B Electromagnetic compatibility of multimedia equipment. Emission Requirements
EN IEC 61000-3-2:2019 and IEC 61000-3-2:2018 Limits for harmonic current emissions (equipment input current ≤ 16 A per phase)
EN 61000-3-3:2013/A1:2019 Limitation of voltage changes, voltage fluctuations and flicker in public low-voltage supply systems, for equipment with rated current ≤ 16 A per phase and not subject to conditional connection
EN 55035:2017/A11:2020, CISPR 35:2016 modified Electromagnetic compatibility of multimedia equipment. Immunity requirements
EN 61000-4-2:2009 EN 61000-4-3:2006+A1:2008 +A2:2010, EN 61000-4-4:2012, EN 61000-4-5:2014+A1:2017, EN 61000-4-6:2014+AC:2015, EN 61000-4-8:2010, EN 61000-4-11:2004+A1:2017 Testing and measurement techniques (11. standards)

Directive 2011/65/EC Restriction of the use of certain Hazardous Substances in electrical and electronic equipment (RoHS) (9. directive)

EN 50581:2012 & EN IEC 63000:2018 Technical documentation for the assessment of electrical and electronic products with respect to the restriction of hazardous substances (11. standards)

2014/35/EU Low voltage (LVD) Directive (9. directive)

EN 62368-1:2014+A11: 2017 Audio/video, information and communication technology equipment - Part 1: Safety requirements
EC 60664-1: 1.48 Insulation Coordination For Equipment Within Low-Voltage Supply Systems - Part 1: Principles, Requirements And Tests
IEC 60950 Methods Of Measurement Of Touch Current And Protective Conductor Current
IEC 62471-5: 2015 Photobiological Safety Of Lamps And Lamp Systems. Image Projectors (11. standards)

Directive 2012/19/EU of the European Parliament and of the Council of 4 July 2012 on waste electrical and electronic equipment (WEEE) (9. directive)

Directive 2005/20/EC of the European Parliament and of the Council of 9 March 2005 amending Directive 94/62/EC on packaging and packaging waste (9. directive)

Directive 2006/66/EC of the European Parliament and of the Council of 6 September 2006 on batteries and accumulators and waste batteries and accumulators (9. directive)

Directive 2009/125/EC of the European Parliament and of the Council of 21 October 2009 establishing a framework for the setting of ecodesign requirements for energy-related products (ErP) (9. directive)

Regulation (EC) No 1907/2006 of the European Parliament and of the Council of 18 December 2006 concerning the Registration, Evaluation, Authorisation and Restriction of Chemicals (REACH) (10. regulation)

Signed for and on behalf of: **MAXNERVA TECHNOLOGY SERVICES LIMITED**, Hong Kong, August 02, 2021.

Signature: Cheng Yee Pun
Cheng Yee Pun (Aug 2, 2021 11:34 GMT+8)

Name: CHENG Yee Pun

Designation: CFO & Authorised Signatory



EU Declaration of Conformity

20210802-001
(1. document number)

2021/08
(2. Year, Month in which the CE mark is affixed)

We, **MAXNERVA TECHNOLOGY SERVICES LIMITED**
(3. company name & manufacturer)

Room 1001, 10/F Houston Centre 63 Mody Road, Tsim Sha Tsui East, Kowloon, Hong Kong
(4. address)

declare under our sole responsibility that the product(s):

P161
(5. the regulatory model)
IN1024, IN1034, IN1044
(6. marketing references)
LCD Projector
(7. product type)
INFOCUS
(8. brand)

The designated product(s) is (are) in conformity with the essential requirements of the following European Directives and Regulations, by compliance with the European and International standards or other specifications as listed:

Directive 2014/30/EU of the Electromagnetic Compatibility (EMC) Directive (9. directive)

EN 55032:2015+A11:2020, CISPR 32:2015+A1:2019: Class B Electromagnetic compatibility of multimedia equipment. Emission Requirements
EN IEC 61000-3-2:2019 and IEC 61000-3-2:2018 Limits for harmonic current emissions (equipment input current ≤ 16 A per phase)
EN 61000-3-3:2013/A1:2019 Limitation of voltage changes, voltage fluctuations and flicker in public low-voltage supply systems, for equipment with rated current ≤ 16 A per phase and not subject to conditional connection
EN 55035:2017/A11:2020, CISPR 35:2016 modified Electromagnetic compatibility of multimedia equipment. Immunity requirements
EN 61000-4-2:2009 EN 61000-4-3:2006+A1:2008 +A2:2010, EN 61000-4-4:2012, EN 61000-4-5:2014+A1:2017, EN 61000-4-6:2014+AC:2015, EN 61000-4-8:2010, EN 61000-4-11:2004+A1:2017 Testing and measurement techniques (11. standards)

Directive 2011/65/EC Restriction of the use of certain Hazardous Substances in electrical and electronic equipment (RoHS) (9. directive)

EN 50581:2012 & EN IEC 63000:2018 Technical documentation for the assessment of electrical and electronic products with respect to the restriction of hazardous substances (11. standards)

2014/35/EU Low voltage (LVD) Directive (9. directive)

EN 62368-1:2014+A11: 2017 Audio/video, information and communication technology equipment - Part 1: Safety requirements
EC 60664-1: 1.48 Insulation Coordination For Equipment Within Low-Voltage Supply Systems - Part 1: Principles, Requirements And Tests
IEC 60950 Methods Of Measurement Of Touch Current And Protective Conductor Current
IEC 62471-5: 2015 Photobiological Safety Of Lamps And Lamp Systems. Image Projectors (11. standards)

Directive 2012/19/EU of the European Parliament and of the Council of 4 July 2012 on waste electrical and electronic equipment (WEEE) (9. directive)

Directive 2005/20/EC of the European Parliament and of the Council of 9 March 2005 amending Directive 94/62/EC on packaging and packaging waste (9. directive)

Directive 2006/66/EC of the European Parliament and of the Council of 6 September 2006 on batteries and accumulators and waste batteries and accumulators (9. directive)

Directive 2009/125/EC of the European Parliament and of the Council of 21 October 2009 establishing a framework for the setting of ecodesign requirements for energy-related products (ErP) (9. directive)

Regulation (EC) No 1907/2006 of the European Parliament and of the Council of 18 December 2006 concerning the Registration, Evaluation, Authorisation and Restriction of Chemicals (REACH) (10. regulation)

Signed for and on behalf of: **MAXNERVA TECHNOLOGY SERVICES LIMITED**, Hong Kong, August 02, 2021.

Signature: Cheng Yee Pun
Cheng Yee Pun (Aug 2, 2021 11:28 GMT+8)
Name: CHENG Yee Pun
Designation: CFO & Authorised Signatory



EU Declaration of Conformity

20210802-002
(1. document number)

2021/08
(2. Year, Month in which the CE mark is affixed)

We, **MAXNERVA TECHNOLOGY SERVICES LIMITED**
(3. company name & manufacturer)

Room 1001, 10/F Houston Centre 63 Mody Road, Tsim Sha Tsui East, Kowloon, Hong Kong
(4. address)

declare under our sole responsibility that the product(s):

P162
(5. the regulatory model)
IN1026, IN1036, IN1046
(6. marketing references)
LCD Projector
(7. product type)
INFOCUS
(8. brand)

The designated product(s) is (are) in conformity with the essential requirements of the following European Directives and Regulations, by compliance with the European and International standards or other specifications as listed:

Directive 2014/30/EU of the Electromagnetic Compatibility (EMC) Directive (9. directive)

EN 55032:2015+A11:2020, CISPR 32:2015+A1:2019: Class B Electromagnetic compatibility of multimedia equipment. Emission Requirements
EN IEC 61000-3-2:2019 and IEC 61000-3-2:2018 Limits for harmonic current emissions (equipment input current ≤ 16 A per phase)
EN 61000-3-3:2013/A1:2019 Limitation of voltage changes, voltage fluctuations and flicker in public low-voltage supply systems, for equipment with rated current ≤ 16 A per phase and not subject to conditional connection
EN 55035:2017/A11:2020, CISPR 35:2016 modified Electromagnetic compatibility of multimedia equipment. Immunity requirements
EN 61000-4-2:2009 EN 61000-4-3:2006+A1:2008 +A2:2010, EN 61000-4-4:2012, EN 61000-4-5:2014+A1:2017, EN 61000-4-6:2014+AC:2015, EN 61000-4-8:2010, EN 61000-4-11:2004+A1:2017 Testing and measurement techniques (11. standards)

Directive 2011/65/EC Restriction of the use of certain Hazardous Substances in electrical and electronic equipment (RoHS) (9. directive)

EN 50581:2012 & EN IEC 63000:2018 Technical documentation for the assessment of electrical and electronic products with respect to the restriction of hazardous substances (11. standards)

2014/35/EU Low voltage (LVD) Directive (9. directive)

EN 62368-1:2014+A11: 2017 Audio/video, information and communication technology equipment - Part 1: Safety requirements
EC 60664-1: 1.48 Insulation Coordination For Equipment Within Low-Voltage Supply Systems - Part 1: Principles, Requirements And Tests
IEC 60950 Methods Of Measurement Of Touch Current And Protective Conductor Current
IEC 62471-5: 2015 Photobiological Safety Of Lamps And Lamp Systems. Image Projectors (11. standards)

Directive 2012/19/EU of the European Parliament and of the Council of 4 July 2012 on waste electrical and electronic equipment (WEEE) (9. directive)

Directive 2005/20/EC of the European Parliament and of the Council of 9 March 2005 amending Directive 94/62/EC on packaging and packaging waste (9. directive)

Directive 2006/66/EC of the European Parliament and of the Council of 6 September 2006 on batteries and accumulators and waste batteries and accumulators (9. directive)

Directive 2009/125/EC of the European Parliament and of the Council of 21 October 2009 establishing a framework for the setting of ecodesign requirements for energy-related products (ErP) (9. directive)

Regulation (EC) No 1907/2006 of the European Parliament and of the Council of 18 December 2006 concerning the Registration, Evaluation, Authorisation and Restriction of Chemicals (REACH) (10. regulation)

Signed for and on behalf of: **MAXNERVA TECHNOLOGY SERVICES LIMITED**, Hong Kong, August 02, 2021.

Signature: 
Cheng Yee Pun (Aug 2, 2021 11:29 GMT+8)

Name: CHENG Yee Pun

Designation: CFO & Authorised Signatory



EU Declaration of Conformity

20210802-003
(1. document number)

2021/08
(2. Year, Month in which the CE mark is affixed)

We, **MAXNERVA TECHNOLOGY SERVICES LIMITED**
(3. company name & manufacturer)

Room 1001, 10/F Houston Centre 63 Mody Road, Tsim Sha Tsui East, Kowloon, Hong Kong
(4. address)

declare under our sole responsibility that the product(s):

P163
(5. the regulatory model)
IN1029, IN1039, IN1049, IN1059
(6. marketing references)
LCD Projector
(7. product type)
INFOCUS
(8. brand)

The designated product(s) is (are) in conformity with the essential requirements of the following European Directives and Regulations, by compliance with the European and International standards or other specifications as listed:

Directive 2014/30/EU of the Electromagnetic Compatibility (EMC) Directive (9. directive)

EN 55032:2015+A11:2020, CISPR 32:2015+A1:2019: Class B Electromagnetic compatibility of multimedia equipment. Emission Requirements
EN IEC 61000-3-2:2019 and IEC 61000-3-2:2018 Limits for harmonic current emissions (equipment input current ≤ 16 A per phase)
EN 61000-3-3:2013/A1:2019 Limitation of voltage changes, voltage fluctuations and flicker in public low-voltage supply systems, for equipment with rated current ≤ 16 A per phase and not subject to conditional connection
EN 55035:2017/A11:2020, CISPR 35:2016 modified Electromagnetic compatibility of multimedia equipment. Immunity requirements
EN 61000-4-2:2009 EN 61000-4-3:2006+A1:2008 +A2:2010, EN 61000-4-4:2012, EN 61000-4-5:2014+A1:2017, EN 61000-4-6:2014+AC:2015, EN 61000-4-8:2010, EN 61000-4-11:2004+A1:2017 Testing and measurement techniques (11. standards)

Directive 2011/65/EC Restriction of the use of certain Hazardous Substances in electrical and electronic equipment (RoHS) (9. directive)

EN 50581:2012 & EN IEC 63000:2018 Technical documentation for the assessment of electrical and electronic products with respect to the restriction of hazardous substances (11. standards)

2014/35/EU Low voltage (LVD) Directive (9. directive)

EN 62368-1:2014+A11: 2017 Audio/video, information and communication technology equipment - Part 1: Safety requirements
EC 60664-1: 1.48 Insulation Coordination For Equipment Within Low-Voltage Supply Systems - Part 1: Principles, Requirements And Tests
IEC 60950 Methods Of Measurement Of Touch Current And Protective Conductor Current
IEC 62471-5: 2015 Photobiological Safety Of Lamps And Lamp Systems. Image Projectors (11. standards)

Directive 2012/19/EU of the European Parliament and of the Council of 4 July 2012 on waste electrical and electronic equipment (WEEE) (9. directive)

Directive 2005/20/EC of the European Parliament and of the Council of 9 March 2005 amending Directive 94/62/EC on packaging and packaging waste (9. directive)

Directive 2006/66/EC of the European Parliament and of the Council of 6 September 2006 on batteries and accumulators and waste batteries and accumulators (9. directive)

Directive 2009/125/EC of the European Parliament and of the Council of 21 October 2009 establishing a framework for the setting of ecodesign requirements for energy-related products (ErP) (9. directive)

Regulation (EC) No 1907/2006 of the European Parliament and of the Council of 18 December 2006 concerning the Registration, Evaluation, Authorisation and Restriction of Chemicals (REACH) (10. regulation)

Signed for and on behalf of: **MAXNERVA TECHNOLOGY SERVICES LIMITED**, Hong Kong, August 02, 2021.

Signature: Cheng Yee Pun
Cheng Yee Pun (Aug 2, 2021 11:33 GMT+8)

Name: CHENG Yee Pun

Designation: CFO & Authorised Signatory



UK Declaration of Conformity

20210907-009
(1. document number)

2021/09
(2. Year, Month in which the UKCA mark is affixed)

We, **MAXNERVA TECHNOLOGY SERVICES LIMITED**
(3. company name & manufacturer)

Room 1001, 10/F Houston Centre 63 Mody Road, Tsim Sha Tsui East, Kowloon, Hong Kong
(4. address)

declare under our sole responsibility that the product(s):

P160
(5. the regulatory model)
IN1004, IN1014
(6. marketing references)
DLP Projector
(7. product type)
INFOCUS
(8. brand)

The designated product(s) is (are) in conformity with the essential requirements of the following UK Directives and Regulations, by compliance with the European and International standards or other specifications as listed:

The Electromagnetic Compatibility Regulations 2016 (9. regulations)

EN 55032:2015+A11:2020, CISPR 32:2015+A1:2019: Class B Electromagnetic compatibility of multimedia equipment. Emission Requirements
EN IEC 61000-3-2:2019 and IEC 61000-3-2:2018 Limits for harmonic current emissions (equipment input current ≤ 16 A per phase)
EN 61000-3-3:2013/A1:2019 Limitation of voltage changes, voltage fluctuations and flicker in public low-voltage supply systems, for equipment with rated current ≤ 16 A per phase and not subject to conditional connection
EN 55035:2017+A11:2020, CISPR 35:2016 modified Electromagnetic compatibility of multimedia equipment. Immunity requirements
EN 61000-4-2:2009 EN 61000-4-3:2006+A1:2008 +A2:2010, EN 61000-4-4:2012, EN 61000-4-5:2014+A1:2017, EN 61000-4-6:2014+AC:2015, EN 61000-4-8:2010, EN 61000-4-11:2004+A1:2017 Testing and measurement techniques (11. standards)

Restriction of the Use of Certain Hazardous Substances in Electrical and Electronic Equipment Regulations 2012 (9. regulations)

EN 50581:2012 & EN IEC 63000:2018 Technical documentation for the assessment of electrical and electronic products with respect to the restriction of hazardous substances (11. standards)

Electrical Equipment (Safety) Regulations 2016 (9. regulations)

EN 62368-1:2014+A11: 2017 Audio/video, information and communication technology equipment - Part 1: Safety requirements
EC 60664-1: 1.48 Insulation Coordination For Equipment Within Low-Voltage Supply Systems - Part 1: Principles, Requirements And Tests
IEC 60990 Methods Of Measurement Of Touch Current And Protective Conductor Current
IEC 62471-5: 2015 Photobiological Safety Of Lamps And Lamp Systems. Image Projectors (11. standards)

The Waste Electric and Electronic Equipment (WEEE) Regulations 2013 (9. regulations)

Producer Responsibilities Obligations (Packaging Waste) Regulations 2007 (9. regulations).

Batteries and Accumulators (Placing on the Market) Regulations 2008 (9. regulations)

Ecodesign for Energy-Related Products Regulations 2010 (9. regulations)

UK Registration, Evaluation, Authorisation and Restriction of Chemicals (REACH) Regulations 2021 (9. regulations)

Signed for and on behalf of: **MAXNERVA TECHNOLOGY SERVICES LIMITED**, Hong Kong, July 7, 2021.

Signature: Cheng Yee Pun
Cheng Yee Pun (Sep 7, 2021, 10:25 GMT+8)

Signature:

Name: CHENG Yee Pun

Designation: CFO & Authorised Signatory



UK Declaration of Conformity

20210907-010
(1. document number)

2021/09
(2. Year, Month in which the UKCA mark is affixed)

We, **MAXNERVA TECHNOLOGY SERVICES LIMITED**
(3. company name & manufacturer)

Room 1001, 10/F Houston Centre 63 Mody Road, Tsim Sha Tsui East, Kowloon, Hong Kong
(4. address)

declare under our sole responsibility that the product(s):

P161
(5. the regulatory model)
IN1024, IN1034, IN1044
(6. marketing references)
DLP Projector
(7. product type)
INFOCUS
(8. brand)

The designated product(s) is (are) in conformity with the essential requirements of the following UK Directives and Regulations, by compliance with the European and International standards or other specifications as listed:

The Electromagnetic Compatibility Regulations 2016 (9. regulations)

EN 55032:2015+A11:2020, CISPR 32:2015+A1:2019: Class B Electromagnetic compatibility of multimedia equipment. Emission Requirements
EN IEC 61000-3-2:2019 and IEC 61000-3-2:2018 Limits for harmonic current emissions (equipment input current ≤ 16 A per phase)
EN 61000-3-3:2013/A1:2019 Limitation of voltage changes, voltage fluctuations and flicker in public low-voltage supply systems, for equipment with rated current ≤ 16 A per phase and not subject to conditional connection
EN 55035:2017+A11:2020, CISPR 35:2016 modified Electromagnetic compatibility of multimedia equipment. Immunity requirements
EN 61000-4-2:2009 EN 61000-4-3:2006+A1:2008 +A2:2010, EN 61000-4-4:2012, EN 61000-4-5:2014+A1:2017, EN 61000-4-6:2014+AC:2015, EN 61000-4-8:2010, EN 61000-4-11:2004+A1:2017 Testing and measurement techniques (11. standards)

Restriction of the Use of Certain Hazardous Substances in Electrical and Electronic Equipment Regulations 2012 (9. regulations)

EN 50581:2012 & EN IEC 63000:2018 Technical documentation for the assessment of electrical and electronic products with respect to the restriction of hazardous substances (11. standards)

Electrical Equipment (Safety) Regulations 2016 (9. regulations)

EN 62368-1:2014+A11:2017 Audio/video, information and communication technology equipment - Part 1: Safety requirements
EC 60664-1: 1.48 Insulation Coordination For Equipment Within Low-Voltage Supply Systems - Part 1: Principles, Requirements And Tests
IEC 60990 Methods Of Measurement Of Touch Current And Protective Conductor Current
IEC 62471-5: 2015 Photobiological Safety Of Lamps And Lamp Systems. Image Projectors (11. standards)

The Waste Electric and Electronic Equipment (WEEE) Regulations 2013 (9. regulations)

Producer Responsibilities Obligations (Packaging Waste) Regulations 2007 (9. regulations).

Batteries and Accumulators (Placing on the Market) Regulations 2008 (9. regulations)

Ecodesign for Energy-Related Products Regulations 2010 (9. regulations)

UK Registration, Evaluation, Authorisation and Restriction of Chemicals (REACH) Regulations 2021 (9. regulations)

Signed for and on behalf of: **MAXNERVA TECHNOLOGY SERVICES LIMITED**, Hong Kong, July 7, 2021.

Signature: Cheng Yee Pun
Cheng Yee Pun (Sep 7, 2021 10:30 GMT+8)

Name: CHENG Yee Pun
Designation: CFO & Authorised Signatory



UK CA

UK Declaration of Conformity

20210907-011
(1. document number)

2021/09
(2. Year, Month in which the UKCA mark is affixed)

We, **MAXNERVA TECHNOLOGY SERVICES LIMITED**
(3. company name & manufacturer)

Room 1001, 10/F Houston Centre 63 Mody Road, Tsim Sha Tsui East, Kowloon, Hong Kong
(4. address)

declare under our sole responsibility that the product(s):

P162
(5. the regulatory model)
IN1026, IN1036, IN1046
(6. marketing references)
DLP Projector
(7. product type)
INFOCUS
(8. brand)

The designated product(s) is (are) in conformity with the essential requirements of the following UK Directives and Regulations, by compliance with the European and International standards or other specifications as listed:

The Electromagnetic Compatibility Regulations 2016 (9. regulations)

EN 55032:2015+A11:2020, CISPR 32:2015+A1:2019: Class B Electromagnetic compatibility of multimedia equipment. Emission Requirements
EN IEC 61000-3-2:2019 and IEC 61000-3-2:2018 Limits for harmonic current emissions (equipment input current ≤ 16 A per phase)
EN 61000-3-3:2013/A1:2019 Limitation of voltage changes, voltage fluctuations and flicker in public low-voltage supply systems, for equipment with rated current ≤ 16 A per phase and not subject to conditional connection
EN 55035:2017+A11:2020, CISPR 35:2016 modified Electromagnetic compatibility of multimedia equipment. Immunity requirements
EN 61000-4-2:2009 EN 61000-4-3:2006+A1:2008 +A2:2010, EN 61000-4-4:2012, EN 61000-4-5:2014+A1:2017, EN 61000-4-6:2014+AC:2015, EN 61000-4-8:2010, EN 61000-4-11:2004+A1:2017 Testing and measurement techniques (11. standards)

Restriction of the Use of Certain Hazardous Substances in Electrical and Electronic Equipment Regulations 2012 (9. regulations)

EN 50581:2012 & EN IEC 63000:2018 Technical documentation for the assessment of electrical and electronic products with respect to the restriction of hazardous substances (11. standards)

Electrical Equipment (Safety) Regulations 2016 (9. regulations)

EN 62368-1:2014+A11: 2017 Audio/video, information and communication technology equipment - Part 1: Safety requirements
EC 60664-1: 1.48 Insulation Coordination For Equipment Within Low-Voltage Supply Systems - Part 1: Principles, Requirements And Tests
IEC 60990 Methods Of Measurement Of Touch Current And Protective Conductor Current
IEC 62471-5: 2015 Photobiological Safety Of Lamps And Lamp Systems. Image Projectors (11. standards)

The Waste Electric and Electronic Equipment (WEEE) Regulations 2013 (9. regulations)

Producer Responsibilities Obligations (Packaging Waste) Regulations 2007 (9. regulations).

Batteries and Accumulators (Placing on the Market) Regulations 2008 (9. regulations)

Ecodesign for Energy-Related Products Regulations 2010 (9. regulations)

UK Registration, Evaluation, Authorisation and Restriction of Chemicals (REACH) Regulations 2021 (9. regulations)

Signed for and on behalf of: **MAXNERVA TECHNOLOGY SERVICES LIMITED**, Hong Kong, July 7, 2021.

Cheng Yee Pun
Cheng Yee Pun (Sep 11, 2021 10:33 GMT+8)

Signature:

Name:

CHENG Yee Pun

Designation:

CFO & Authorised Signatory



**UK
CA**

UK Declaration of Conformity

20210907-012
(1. document number)

2021/09
(2. Year, Month in which the UKCA mark is affixed)

We, **MAXNERVA TECHNOLOGY SERVICES LIMITED**
(3. company name & manufacturer)

Room 1001, 10/F Houston Centre 63 Mody Road, Tsim Sha Tsui East, Kowloon, Hong Kong
(4. address)

declare under our sole responsibility that the product(s):

P163
(5. the regulatory model)
IN1029, IN1039, IN1049, IN1059
(6. marketing references)
DLP Projector
(7. product type)
INFOCUS
(8. brand)

The designated product(s) is (are) in conformity with the essential requirements of the following UK Directives and Regulations, by compliance with the European and International standards or other specifications as listed:

The Electromagnetic Compatibility Regulations 2016 (9. regulations)

EN 55032:2015+A11:2020, CISPR 32:2015+A1:2019: Class B Electromagnetic compatibility of multimedia equipment. Emission Requirements
EN IEC 61000-3-2:2019 and IEC 61000-3-2:2018 Limits for harmonic current emissions (equipment input current ≤ 16 A per phase)
EN 61000-3-3:2013/A1:2019 Limitation of voltage changes, voltage fluctuations and flicker in public low-voltage supply systems, for equipment with rated current ≤ 16 A per phase and not subject to conditional connection
EN 55035:2017+A11:2020, CISPR 35:2016 modified Electromagnetic compatibility of multimedia equipment. Immunity requirements
EN 61000-4-2:2009 EN 61000-4-3:2006+A1:2008 +A2:2010, EN 61000-4-4:2012, EN 61000-4-5:2014+A1:2017, EN 61000-4-6:2014+AC:2015, EN 61000-4-8:2010, EN 61000-4-11:2004+A1:2017 Testing and measurement techniques (11. standards)

Restriction of the Use of Certain Hazardous Substances in Electrical and Electronic Equipment Regulations 2012 (9. regulations)

EN 50581:2012 & EN IEC 63000:2018 Technical documentation for the assessment of electrical and electronic products with respect to the restriction of hazardous substances (11. standards)

Electrical Equipment (Safety) Regulations 2016 (9. regulations)

EN 62368-1:2014+A11: 2017 Audio/video, information and communication technology equipment - Part 1: Safety requirements
EC 60664-1: 1.48 Insulation Coordination For Equipment Within Low-Voltage Supply Systems - Part 1: Principles, Requirements And Tests
IEC 60990 Methods Of Measurement Of Touch Current And Protective Conductor Current
IEC 62471-5: 2015 Photobiological Safety Of Lamps And Lamp Systems. Image Projectors (11. standards)

The Waste Electric and Electronic Equipment (WEEE) Regulations 2013 (9. regulations)

Producer Responsibilities Obligations (Packaging Waste) Regulations 2007 (9. regulations).

Batteries and Accumulators (Placing on the Market) Regulations 2008 (9. regulations)

Ecodesign for Energy-Related Products Regulations 2010 (9. regulations)

UK Registration, Evaluation, Authorisation and Restriction of Chemicals (REACH) Regulations 2021 (9. regulations)

Signed for and on behalf of: **MAXNERVA TECHNOLOGY SERVICES LIMITED**, Hong Kong, July 7, 2021.

Signature: Cheng Yee Pun
Cheng Yee Pun (Sep 8, 2021 09:13 GMT+8)

Name: CHENG Yee Pun
Designation: CFO & Authorised Signatory



INFOCUS LIMITED WARRANTY

For product purchases effective 1st January 2021

WARRANTY STATEMENT

In Focus warrants its products to be free from defects in material and workmanship during the warranty period. If a product proves to be defective in material or workmanship during the warranty period, In Focus will, at its sole option, repair or replace the product with a similar product. Replacement Products or parts may include remanufactured or refurbished parts or components. The replacement unit will be covered by the balance of time remaining on the customer's original limited warranty. In Focus provides no warranty for any third-party software whether included with the product or installed by the customer, installation of any unauthorized or third party hardware parts or components (e.g. Projector Lamps).

DEAD ON ARRIVAL (DOA)

All brand new In Focus products carry a thirty (30) day Dead on Arrival (DOA) warranty policy for the first consumer purchaser. A new replacement unit will be provided if the Product is found to be non-operational within thirty (30) days of purchase and freight shall be covered both ways by InFocus.

WHO THE WARRANTY PROTECTS

This warranty is valid only for the first consumer purchaser, it is nontransferable.

WARRANTY PERIOD

Product	Period
Laser Illuminated Projectors	5 years or 20,000 hours which ever comes first
Lamp & LED Illuminated Projectors	2 years
Interactive Touch Displays	3 years
OPS and Slotable PC's	1 year
Original Lamp Contained Within Projector	1 year or 1,000 hours which ever comes first
Replacement lamps and Other Accessories	3 months

WHAT THE WARRANTY DOES NOT COVER

1. Any product on which the serial number has been defaced, modified or removed.
2. Damage, deterioration or malfunction resulting from:
 - a. Accident, misuse, neglect, fire, water, lightning, or other acts of nature, unauthorized product modification, or failure to follow instructions supplied with the product.
 - b. Repair or attempted repair by anyone not authorized by In Focus.
 - c. Damage to or loss of any programs, data or removable storage media.
 - d. Software or data loss occurring during repair or replacement.
 - e. Any damage of the product due to shipment.
 - f. Removal or installation of the product.
 - g. Causes external to the product, such as electric power fluctuations or failure.
 - h. Use of supplies or parts not meeting InFocus specifications.
 - i. Normal wear and tear.
 - j. Failure of owner to perform periodic product maintenance as stated in User Guide.
 - k. Any other cause which does not relate to a product defect.
 - l. Damage caused by static (non-moving) images displayed for lengthy periods of time (image burn-in).
 - m. Any third-party software included with the product or installed by the customer.
 - n. Installation of any unauthorized hardware, accessories, consumable parts or components.
 - o. Damage to, or abuse of, the coating on the surface of the display through inappropriate cleaning as described in product User Guide.

OBTAINING WARRANTY SERVICE

Submit your request to us on line: <https://infocus.com/support/technical-support/or> call your local In Focus support hotline which can be found at: <https://infocus.com/support/contact-us/> Be sure to read our RMA instruction closely to ensure a smooth and timely process of your report, these will be sent to you with the RMA confirmation.



NOTICE

Products presented for delivery at In Focus repair or logistics center without an assigned RMA will be refused and returned to sender. Products delivered to In Focus repair or logistics center damaged will be held and customer will be notified. It is the responsibility of sender to file claims directly with their freight carrier company.

LIMITATION OF IMPLIED WARRANTIES

TO THE EXTENT ALLOWED BY LOCAL LAW, THIS PRODUCT IS PROVIDED TO YOU "AS IS" WITHOUT WARRANTIES OR CONDITIONS OF ANY KIND, WHETHER ORAL OR WRITTEN, EXPRESS OR IMPLIED. INFOCUS SPECIFICALLY DISCLAIMS ANY IMPLIED WARRANTIES OR CONDITIONS OF MERCHANTABILITY, SATISFACTORY QUALITY, NON INFRINGEMENT AND FITNESS FOR A PARTICULAR PURPOSE.

EXCLUSION OF DAMAGES

IN FOCUS'S LIABILITY IS LIMITED TO THE COST OF REPAIR OR REPLACEMENT OF THE PRODUCT. IN FOCUS SHALL NOT BE LIABLE FOR:

1. DAMAGE TO OTHER PROPERTY CAUSED BY ANY DEFECTS IN THE PRODUCT.
2. DAMAGES BASED UPON INCONVENIENCE, LOST PROFIT, LOST DATA OR DOWNTIME COSTS, LOSS OF USE OF THE PRODUCT, LOSS OF TIME, LOSS OF PROFITS, LOSS OF BUSINESS OPPORTUNITY, LOSS OF GOODWILL, INTERFERENCE WITH BUSINESS RELATIONSHIPS, OR OTHER COMMERCIAL LOSS, EVEN IF ADVISED OF THE POSSIBILITY OF SUCH DAMAGES.
3. ANY OTHER DAMAGES, WHETHER DIRECT, SPECIAL, INCIDENTAL, CONSEQUENTIAL OR OTHERWISE.
4. ANY CLAIM AGAINST THE CUSTOMER BY ANY OTHER PARTY.

LOCAL LAW

This warranty gives you specific legal rights, and you may also have other rights which vary from locality to locality. Some localities do not allow limitations on implied warranties and/or do not allow the exclusion of incidental or consequential damages, so the above limitations and exclusions may not apply to you.