

## Potted 250VA Transformer



### Features

- Potted core
- Earth screening
- Thermal cut-off at 130°C
- 115VAC/230VAC configurable
- Dimensions 126mm x 65mm
- Weighs 2.9kg

### Application

- Single UcD400xx (two max). Use with Hypex supplies is recommended

### Description

The TR400 is a 250VA double insulated potted toroidal transformer with earth screening for use with a single UcD400 (two max). It has two pairs of primary windings of 115V and two pairs of secondary windings: 13VAC and 40VAC and can be used in both 230VAC and 115VAC countries.

### Connections

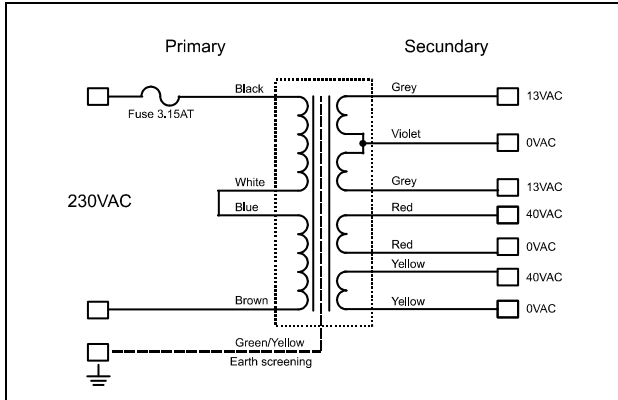

Fig 1. Connection diagram for 230VAC configuration

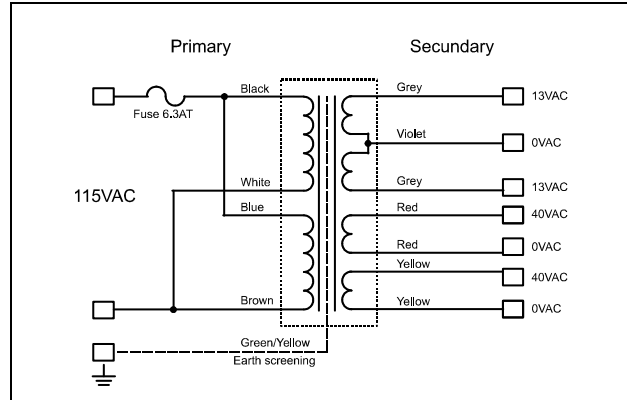

Fig 2. Connection diagram for 115VAC configuration

TR400 lead	HG Supply mono connection	HG Supply connection	Function
(Violet)	(J12)	(J12)	Auxiliary supply (option)
(Grey)	(J14)	(J14)	..
(Violet)	(J13)	(J13)	..
Red	J7	J7	Amplifier main supply
Red	J22	J8	..
Yellow	J8	J8	..
Yellow	J9	J9	..
Green/Yellow			Connect to safety earth