

Cayin®

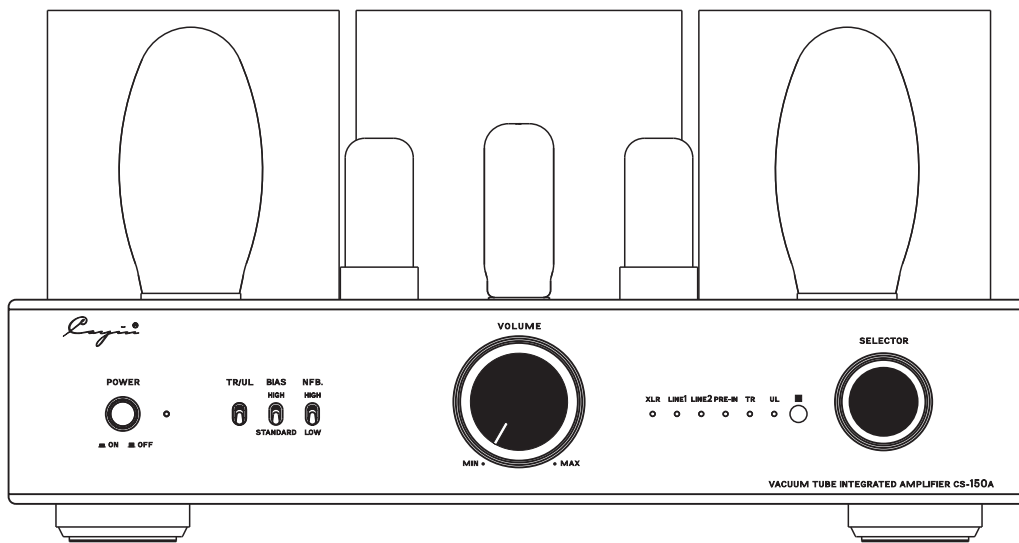

CS-150A | Vacuum Tube Integrated Amplifier

User's Manual



Thanks for choosing **CAYIN CS-150A** Vacuum Tube Integrated Amplifier and please read the user's manual carefully before installation and operation.

In order to prevent damage during transportation, the amplifier is packed with protective foams surrounding the tubes. Before installation and operation, please remove these foams to avoid any risks.

Table of Contents

Table of Contents	1
Package Contents	2
Product Features	3
Safety Precautions	3
Specifications	4
Maintenance	5
Warranty Service	5
Precautions	6
Front Panel	7
Rear Panel	8
Top Panel	9
Remote Control	10
Installation	11
Tube Replacement	11
Audio Connection	12
Speaker Connection	13
Turning on	14
Small Tips	14
Troubleshooting	15

NOTE:

CAYIN CS-150A Vacuum Tube Integrated Amplifier is designed and manufactured with our original parts and reaching the best results. We are not responsible for problems and damages caused by non-original parts replacement in the amplifier.

Package Contents

Please carefully check the package first and then open it.

Package contents include:

- | | |
|-------------------------------|-----------|
| 1. CAYIN CS-150A | 1 piece; |
| 2. Fuses: | |
| Main Fuse T3. 15AL250V | 2 pieces |
| High Voltage Fuse T315mAL250V | 4 pieces. |
| 3. Power cord | 1 piece; |
| 4. Remote Control | 1 piece; |
| 5. (AAA) Battery of 1.5V | 2 pieces; |
| 6. User's Manual | 1 piece; |

Recommendation:

Keep all packing materials for future use .

NOTE:

Please make sure local voltage level is matched with the input level of the amplifier, which indicates on the rear panel. Too low or too high voltage may cause problem. Please contact our company or our local agent if you've found improper voltage.

All other parts except above are not included.



Product Features

- ◆ One hundred watts per channel in Class AB Ultra-linear mode, Fifty-five watts per channel in Triode mode, push pull amplifier design.
- ◆ All tube Integrated with RCA 22DE4 tube rectifier for Power supply, Tung-Sol 6SN7 voltage amplification stage and driver stage and KT150 Output tubes.
- ◆ Two pairs of line inputs, one pair of Pre-In and one pair of XLR input are located on the rear panel of the amplifier.
- ◆ Different from other inputs Pre-In offers you a possibility to connect to some other Preamplifier so that you can use the CS-150A as a power amplifier.
- ◆ Speaker terminals for 4 and 8 ohm speakers are located on the rear panel of the Amplifier.
- ◆ User bias controls for KT150 have been used for bias adjustment and one meter has been added to the top plate to allow you to monitor bias with ease.
- ◆ Bias level selectable for KT150 Power tube. Offer different choice to match with different kinds of speakers to get the best sound performance.
- ◆ Negative Feedback switch is on the front plate that you can choose between two levels of NFB to enjoy the different sound outputs of the CS-150A tube amplifier.
- ◆ Anodized aluminum front, fully vented chassis with excellent gorgeous finish, hand-made construction with the finest point-to-point wiring,
- ◆ Soft-start circuit to protect the amplifier for extended life of sensitive components.
- ◆ Premium Parts: Alps volume control, Audio grade capacitors and carbon film resistor, Toroid transformer for power supply, Wide bandwidth EI output transformer, Ceramic tube sockets, etc.
- ◆ Standard with remote volume control, CS-150A can memorize last operation of the unit once switched off.
- ◆ Available front finish: Silver and Black.

Safety precautions

1. Unplug the power cord if you are not going to use the product for an extended period of time.
2. The machine will become hot after working for a long time. Please keep the unit's ventilation open and install the amplifier at a well-ventilated place to avoid troubles and fire hazard.
3. Forbidden to operate when the output is open or shorted.
4. Do not attempt to service this product yourself. Opening the cover may expose you to dangerous voltage or other hazards.
5. We are not responsible for any problems caused by checking and opening without permission of our company. For service, Please contact a qualified service technician.
6. Do not place any objects filled with liquids such as vases or some others on the top or around.
7. Clean only with dry cloth.
8. Please move the amplifier carefully not to drop the unit or be subject to other strong shocks.



- ◆ To reduce the risk of electric shock, do not remove the cover.
- ◆ No user serviceable parts inside. Refer servicing to qualified service personnel.
- ◆ To reduce the risk of fire or electronic shock, do not expose the unit to rain or moisture.

 The lightning flash with arrowhead symbol is intended to alert user to the presence of uninsulated “dangerous voltage” within the product's enclosure that may be of a risk shock to persons.

 The exclamation point is intended to alert user to the presence of important operation and maintenance (servicing) instructions accompanying the appliance.

Specifications

Power Output	55W+55W (RMS Triode mode)	
	100W+100W (RMS Ultralinear mode)	
Frequency Response	9Hz~50KHz (-3dB)	
THD	2% (1kHz)	
S/N Ratio	90dB	
Input Sensitivity	380mV (Integrated)	
	1200mV (Pre-IN)	
Input Impedance	100kΩ	
Output Impedance	4Ω, 8Ω	
Max Power Consumption	520W	
Tube	TUNG-SOL 6SN7x4、TUNG-SOL KT150x4、RCA 22DE4x1	
WxDxH	420x389x218mm ³	
Net Weight	34kg	
Working Condition	Temperature 0 °C~40 °C	Moisture 20%~80%
Storage Condition	Temperature -20 °C~70 °C	Moisture 20%~90%



Maintenance

NOTE:

- ◆ Use the soft dry cloth to clean up the chassis regularly.
- ◆ Do not use any chemicals for cleaning.

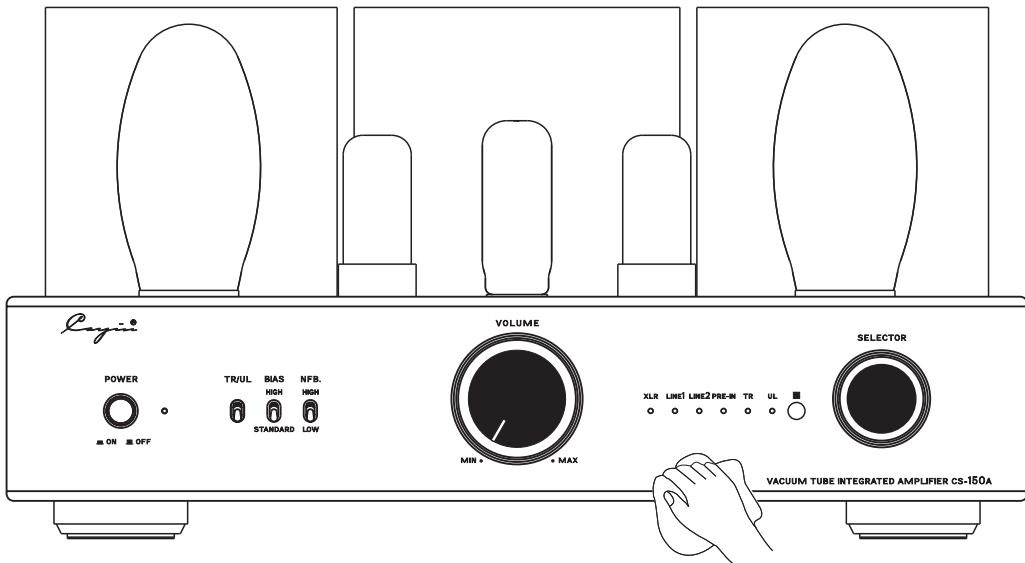

Warranty Service

- 1.This product is warranted for a period of twelve months beginning from the date of purchase.
- 2.The defective product must be returned to your dealer or our company for repairing when your dealer or our company accepts your requirement.
- 3.The warranty doesn't extend to any product that has been opened by you without permission of our company.

NOTE:

The information in this manual is subject to change without further notice.

Precautions

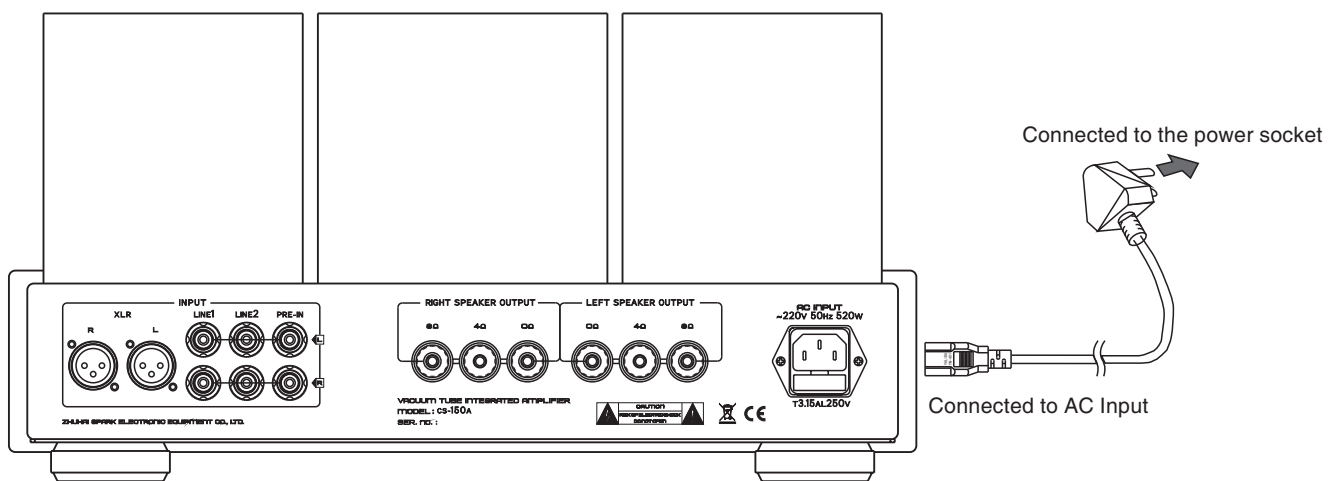

Connection of power cord:

Connect the speaker cables and signal cable first and then insert the power cord into the power socket.

NOTE:

- ◆ Connect the power only after finishing other connections.
- ◆ It is normal that power transformer becomes hot for extended period of operation.
- ◆ Unplug the power cord if you're not going to use the product for an extended period of time.
- ◆ Please make sure corresponding voltage is the same as required. We are not responsible for damage caused by misuse of unsuitable voltage.

Front Panel

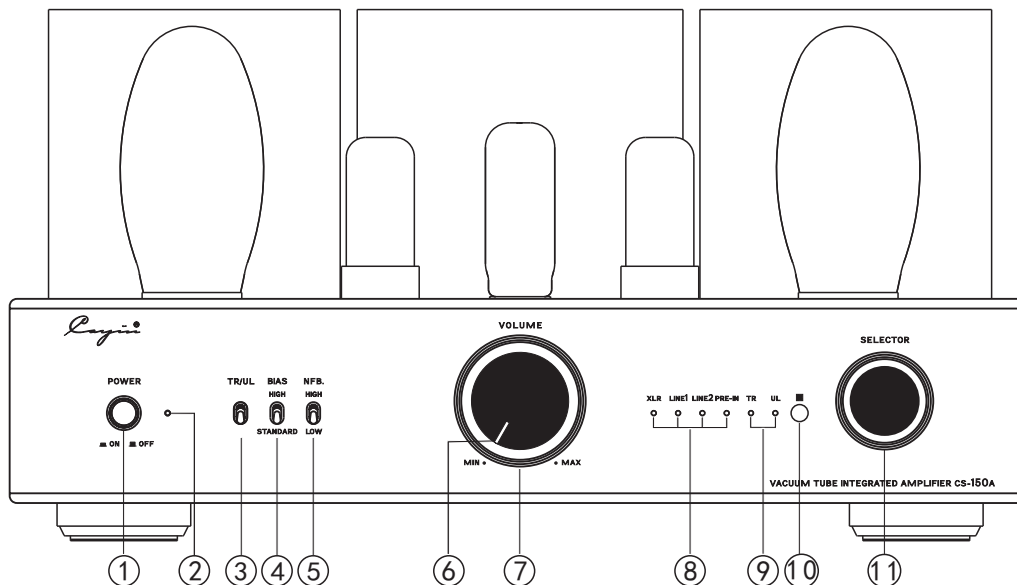

1. Power Switch

Used to switch on/off the amplifier.

Note: Unplug the power cord if you're not going to use the product for an extended period of time.

2. Power indicator

Turn on the amplifier the power indicator will be on.

3. Triode/ Ultralinear Indicator

When the TR Indicator is on: Triode working state

When the UL Indicator is on: Ultralinear working state

Cayin CS-150A has memories and it will default last operation state when turning on.

4. BIAS Selector Switch

Select different levels of bias for KT150 Power tubes. You can choose between High Bias and Standard Bias with this switch.

5. NFB. Selector Switch

Select between High Negative Feedback and Low Negative Feedback.

6. Power Indicator/Mute Indicator

Used to indicate the working state. The indicator will be on when it is working normally. The indicator will flicker for 30 seconds when it delays to work. The indicator will keep flickering when it is at mute state.

7. Volume Knob

Used to control volume

8. Input Selector Knob

You can hear sound from XLR when XLR indicator is on.

You can hear sound from LINE1 when LINE1 indicator is on.

You can hear sound from LINE2 when LINE2 indicator is on.

You can hear sound from PRE-IN when PRE-IN indicator is on.

Cayin CS-150A can memorize last operation of the unit once turned off.

9. Triode/ Ultralinear Indicator

When the TR Indicator is on: Triode working state

When the UL Indicator is on: Ultralinear working state

Cayin CS-150A has memories and it will default last operation state when turning on.

10. IR Remote Sensor

Used to receive the code of remote control. working state.

11. Input Selector Button

Used to select four kinds of audio sources. The input selection indicator will be on according to the input audio sources. This function can be operated on the remote control.

Rear Panel

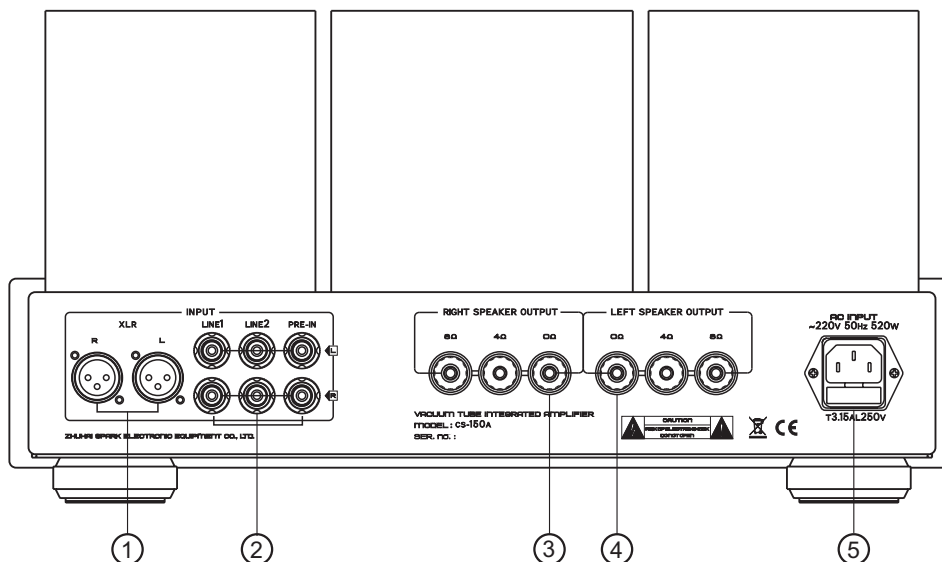

1. Balanced input (XLR)

Connect a balanced audio input to the amplifier. Please make sure the left and right channel is connected correctly.

2. Single-ended input (RCA)

Connect a single-ended audio input to the amplifier. Please make sure the left and right channel is connected correctly.

3. Right Channel Output

Used to connect with the right channel of speaker.

4. Left Channel Output

Used to connect with the left channel of speaker.

5. Power Socket with Main Fuse

Main fuse is located just below the power socket. Replace the fuse with the same type as indicated.



Top Panel

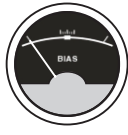
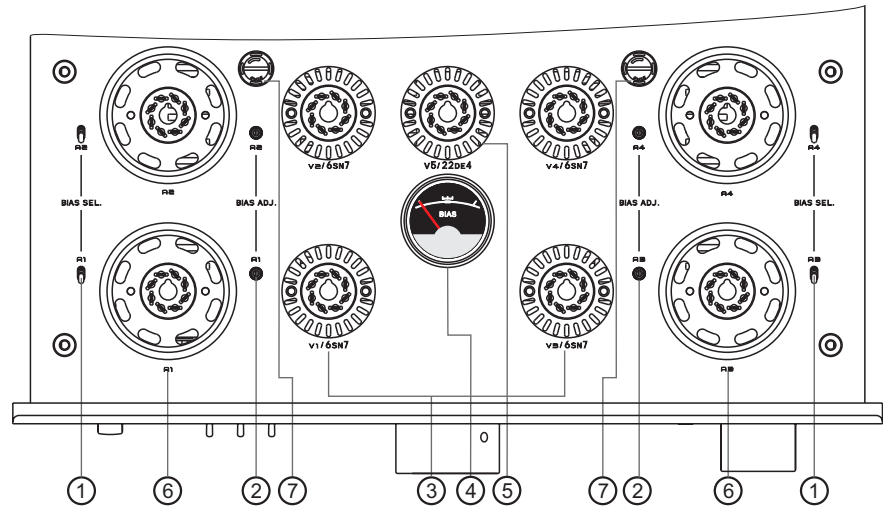

Diagram 4
Bias meter when not working



Diagram 5
Bias meter during working
Note: When working normally, the pointer should stay within the A zone, still, it would move for the voltage fluctuation.

1. **Bias Selector Switch (A1、A2、A3、A4)**
Used to select corresponding tube for bias adjustment.
2. **Bias Adjustment (A1、A2、A3、A4)**
Used to adjust bias of corresponding power tube(A1、A2、A3、A4)
3. **V1、V2、V3、V4: TUNG-SOL 6SN7GTB**
4. **Bias Meter**
Used to monitor the working current of the power tube.
5. **V5: RCA 22DE4**
6. **A1、A2、A3、A4: TUNG-SOL KT150**
7. **KT150 High Voltage Fuse Holder: Left and Right.**

Bias adjustment for the power tube:
Turn the Bias Selector Switch to its opposite direction without releasing it, adjust the corresponding Bias Adjustment Switch with flat screwdriver, and inspect the Bias Meter on the top panel to make sure the pointer keeps in the center. Bias adjustment for A1.A2,A3 and A4 are the same.After all have been djusted, do it one more time to make sure all the bias level of A1,A2,A3 and A4 are the same.

- Sample of bias adjustment for power tube A1:**
1. Turn the Bias Selector Switch A1 to its opposite direction without releasing it.
 2. Adjust the corresponding Bias Adjustment Switch A1 with flat screwdriver until the pointer of the bias meter keeps in the center. The same for A2, A3 and A4.

NOTE

- ◆ Be careful of the high temperature of the tubes during operation.
- ◆ Please replace the power tubes after switch off in 20 minutes, and follow the suggestion to unplug the inset the tubes.
- ◆ Power tubes must be matched for well function.
- ◆ Forbidden to make the pointer of the bias meter out of the A zone when adjusting the power tube.
- ◆ Make sure the supply voltage is 220V before bias adjustment.
- ◆ Even under normal working state, the point of the bias meter could move for the voltage fluctuation.

Remote Control

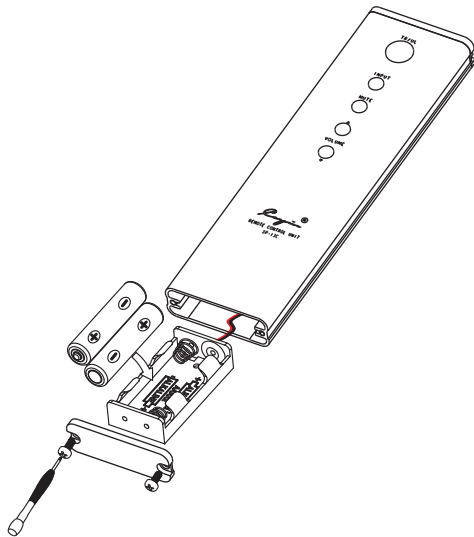

Installation

1. Place the remote control right-side up. Screw the rear cover open with the attached hexagon screwdriver.
2. Pull out the (AAA)battery case carefully (do not break the wires connected).
3. Put in the batteries with correct polarity.
4. Push in the battery case and screw the rear cover close.

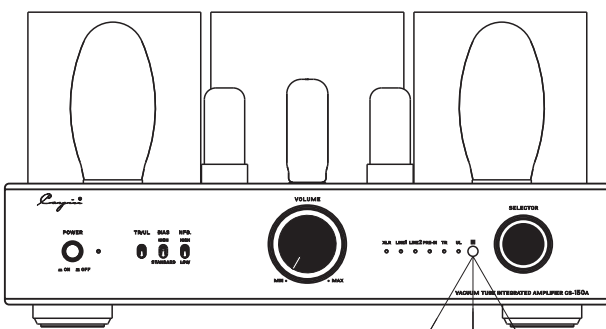
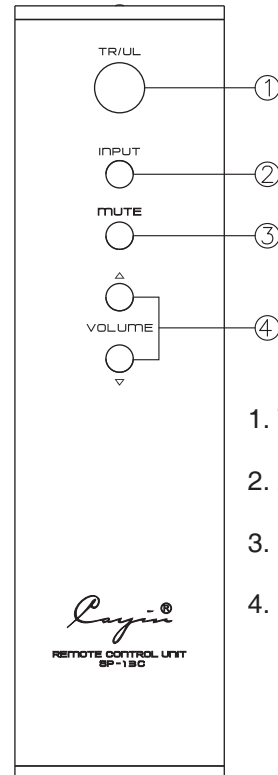

Effective Distance : about 6m

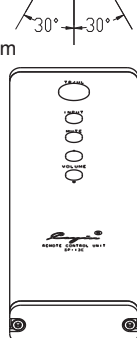

NOTE:

- ◆ Don't drop the remote control. Keep the remote control dry.
- ◆ Replace the batteries timely.
- ◆ Don't mix new and old batteries together and use the batteries with the same specification.
- ◆ Take out the batteries if you don't use the remote control for an extended period of time.
- ◆ Batteries with high quality are recommended.



Installation

Carefully read and follow the manual for installation:

- ◆ Do not place the machine near heat sources such as radiators, heat registers or other products that produce heat.
- ◆ In order to avoid being overheated please keep the unit's ventilation open.
- ◆ Do not expose this appliance to rain or moisture.
- ◆ Keep the amplifier in a certain distance so that it can be easily connected.
- ◆ Amplifier should install steadily and make sure all four feet are on the same level.
- ◆ Keep the amplifier over 15cm's distance to the surrounding walls.

NOTE:

Please make sure local voltage level is matched with the input level of the amplifier, which indicates on the rear panel. Too low or too high voltage may cause problems or shorten the amplifier's life.

Tube Replacement

Tubes for the Machine	Tubes Replacement
TUNG-SOL 6SN7GTB	6SN7GT、6H8C、ECC32、ECC33、6N8P、5692
TUNG-SOL KT150	KT150、KT120
RCA 22DE4	22DE4

Audio Connection

Connection method of **CAYIN CS-150A** with other audio equipments Take pictures below for your reference.

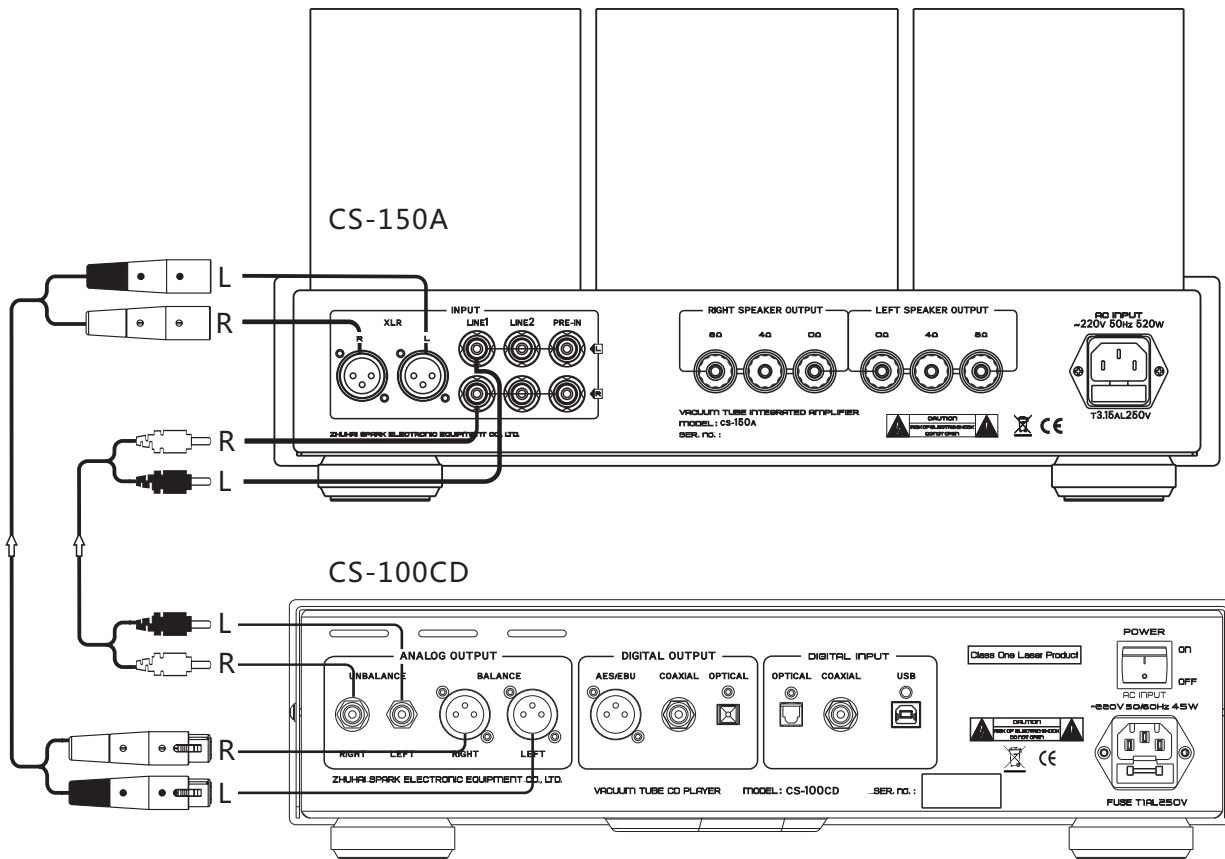

Balanced Connector:

1. This amplifier uses XLR connectors that are commonly used in professional applications for balanced connections.

2. There are two XLR wiring standards:

- European standard: pin 1=Ground, Pin 2 = COLD, Pin 3 = HOT

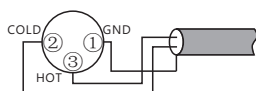

- American standard: pin 1=Ground, Pin 2 = HOT, Pin 3 = COLD

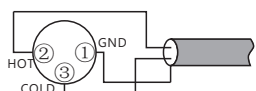

3. This amplifier uses the American standard. When connecting to audio equipment with a balanced output wired in European, the playback signal might be in reversed phase. We advise users to maintain the phase of the system correctly.

Attention to Audio Connection:

1. Please refer to the manual of associated equipment whenever necessary.
2. Do not connect the power cord until all equipment is properly connected.
3. "R" indicates the right channel; "L" indicates left channel.
4. Please make sure all connectors are securely installed. Bad connection might cause noise and degrade in audio performance, or even damage your equipment.
5. Please do not tie the power cord, audio interconnects, and speaker cable together or run them in parallel because this will produce adverse effects on audio performance.

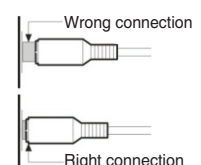

Note: Please make sure + and -, left and right are connected properly.



Speaker Connection

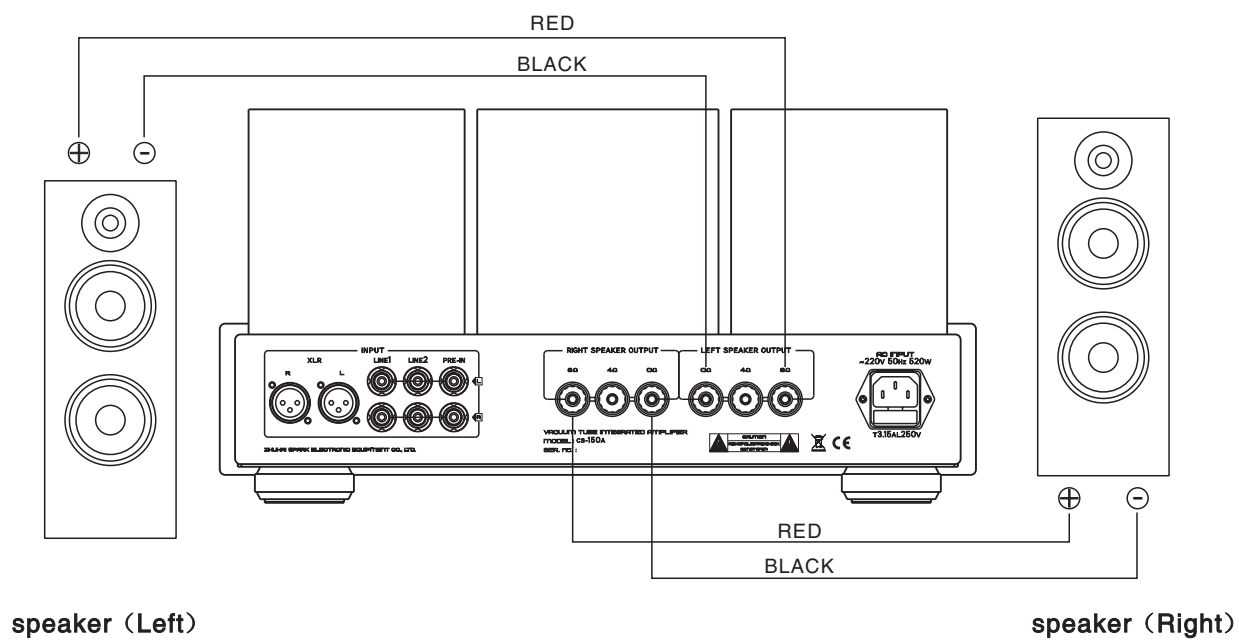

speaker (Left)

speaker (Right)

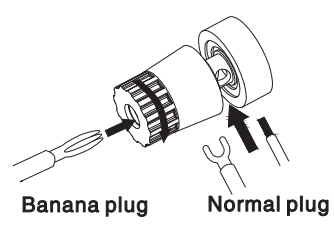

Check the impedance of your speakers:

Attach the positive from your speaker to the 4 or 8 ohm terminal and the negative to the 0 ohm terminals separately. If your speakers are 6 ohm, 4 ohm or 8 ohm (recommended) terminal is preferential and it would not cause damage to the amplifier. Connecting the left and right speakers according to the guidance can make sure of the acoustic fidelity.

Connection of speaker cables:

1. Unscrew the terminal knob
2. Insert the speaker cable
3. Screw the terminal knob

NOTE:

- Connect the speaker cables with the amplifier after it is well connected with the speakers.
- Connect both of the speakers to make sure of the acoustic fidelity.
- Please notice the signal direction indication of the cables.
- Do not mix up the positive and negative ends of speaker cables or it will cause short circuit.

Turning On

Before turning on the amplifier please make sure all connections are right and power supply is stable.

- Turn on the amplifier, the power indicator will be on and the working indicator will keep flickering.
- The working indicator will be on after 30 seconds. It means that the amplifier is working normally. If the working indicator is off, please turn off the power and contact with our local agent or our company.
- Select the right audio source channel, adjust the volume to a certain position and then you can enjoy the music you prefer.

NOTE:

1. When the audio system is under working state, don't unplug the signal cable or speaker cables, or it will cause damage to the amplifier and other equipments.
2. It should at least take 2 minutes before you turn on the power again, or it will cause damage to the vacuum tubes.

Small Tips

Read the Manual— Please read the user's manual carefully before installation and operation.

Keep the Manual— Please keep the manual for future reference.

Warning Signs— Don't tear off or rub off the serial number.

Operation— Do the operations as you are instructed in the Manual.

Parts— If you are going to use parts not supplied by our company like power cord, fuses etc please make sure that parts you used are compatible with the safety requirements. Or it will cause fire or electric shock.

Placement— Put the amplifier on a level place. Make sure that it doesn't bring damage to the children, adults and the amplifier itself.

Power— Please make sure the local voltage is the same level as indicated on the rear panel.

Overload— If the power socket is overloaded with other equipment, it will cause fire or electric shock.

Warranty Service— Do not open the product and change the components inside yourself. Opening the cover may expose you to dangerous voltage or other hazards. The warranty doesn't extend to any product that has been opened by you without permission of our company.

Troubleshooting— If any problems when you are using the product, please check according to following tips to look for the exact reason. Please contact with our company if you can't solve the problem.



Troubleshooting

Please follow the instruction in the manual in order to keep the amplifier work in its best state. If wrongly operated and you thought that would be troubles please check according to following tip to look for the exact reason.

Problem		Cause	Remedy
NO OUTPUT	Power Indicator is OFF.	Power cord is not well-connected.	Check power cable connection or power outlet connection
		Main fuse is out.	Replace with the same type and value fuse.
		Troubles of inner parts or components.	Please contact with local agents or our company.
	Power Indicator is ON.	Volume is at ZERO.	Turn up the Volume.
		NO signal input.	Check the function of the sound source.
			Check the input selection and switch to the proper input.
No Output for the Left Channel	High voltage fuse breaks for the Left Channel	Replace with the same type and value fuse.	
No Output for the Right Channel	High voltage fuse breaks for the Right Channel	Replace with the same type and value fuse.	
Sound Distortion	High input signal level.	Turn down the volume to suitable position.	
Noise output	Ground of input signal cable is open or bad contact of the input signal cable.	Replace the input signal cable with a new one.	
	Components or circuits are in trouble.	Please contact with local agents or our company.	
Sound field Positioning is not so good.	Signal input cables or speaker cables are wrongly connected.	Reconnect it as suggested in the manual.	
Malfunction of Remote Control.	Be disturbed. Low Battery. Obstacles between the amplifier and remote.	Keep away from the source of disturbance. Turn off and restore. Replace with new batteries. Remove the obstacles.	

NOTE: *Cayin*[®] is the registered trademark of Zhuhai Spark Electronic Equipment Co., Ltd.