



Owner's Manual

Battery-Powered Stereo Amplifier

CUBE *Street II*

English

日本語

Deutsch

Français

Italiano

Español

Português

Nederlands

Before using this unit, carefully read "USING THE UNIT SAFELY" and "IMPORTANT NOTES" (leaflet "USING THE UNIT SAFELY" and Owner's Manual (p. 12). After reading, keep the document(s) where it will be available for immediate reference.

© 2021 Roland Corporation

Panel Descriptions

Top Panel

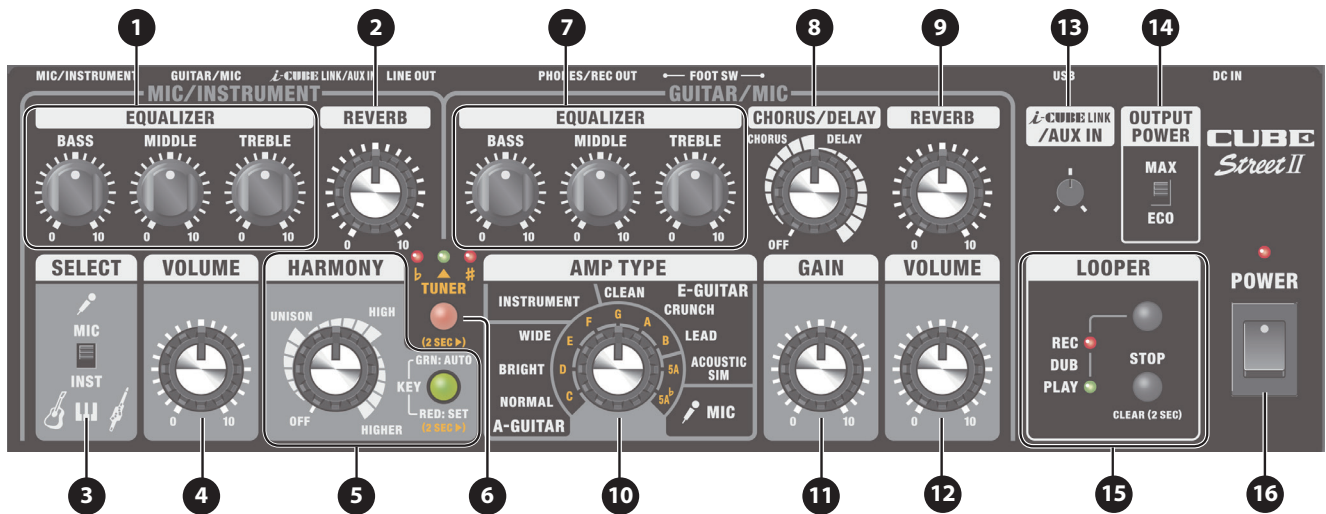

MIC/INSTRUMENT Channel

1 EQUALIZER

[BASS] knob

Adjusts the sound level of the low-frequency range.

[MIDDLE] knob

Adjusts the sound level of the middle-frequency range.

[TREBLE] knob

Adjusts the sound level of the high-frequency range.

2 [REVERB] knob

Adjusts the reverb depth.

3 [SELECT] switch

Switches to the input level that's appropriate for the device you've connected.

Use the "MIC" setting if you're connecting a mic, or use the "INST" setting if you're connecting an acoustic guitar or a keyboard.

4 [VOLUME] knob

Adjusts the volume of the MIC/INSTRUMENT channel.

5 HARMONY

This adds natural harmonies to the audio that is input from the MIC/INSTRUMENT jack.

[HARMONY] knob

Use this to turn the harmony on/off, switch between harmony types and adjust the volume. The setting changes depending on the position of the knob.

Type	Explanation
UNISON	Creates an effect that sounds like someone else singing the same melody together.
HIGH	Adds harmony notes based on upper fourths and thirds. *1
HIGHER	Adds harmony notes based on sixths and fifths. *1

*1 Other pitches may be added under certain conditions.

[KEY] button

This sets the key for the harmony (p. 6).

GUITAR/MIC Channel

6 [TUNER] button

Press to tune your guitar (p. 6).

7 EQUALIZER

[BASS] knob

Adjusts the sound level of the low-frequency range.

[MIDDLE] knob

Adjusts the sound level of the middle-frequency range.

[TREBLE] knob

Adjusts the sound level of the high-frequency range.

8 [CHORUS/DELAY] knob

This knob switches between chorus or delay, depending on the position.

Type	Explanation
CHORUS	Chorus is an effect that creates a beautiful spaciousness and depth by adding a slightly modulated sound.
DELAY	Changes the delay time and effect.

9 [REVERB] knob

Adjusts the reverb depth.

10 [AMP TYPE] knob

Selects the amp type. All provided amp types are original.

[AMP TYPE] knob

This knob switches between amp type variations.

Type	Explanation
A-GUITAR	Use this type when connecting an acoustic guitar. This adjusts the resonance of the acoustic guitar body.
	NORMAL A direct sound that doesn't adjust the resonance.
	BRIGHT A brilliant sound extending to the high range.
	WIDE A full sound with emphasized body resonance.
INSTRUMENT	Select this when connecting a musical instrument.
E-GUITAR	Select this when connecting an electric guitar.
	CLEAN This is an original amp that provides a clean and natural sound with a sense of transparency. Use this together with the chorus and reverb of this unit for a spacious, three-dimensional sound.
	CRUNCH This original amp delivers a fat crunch sound, with each note sounding clearly.
	LEAD This is a high-gain original amp that produces thick-sounding distortion.
	ACOUSTIC SIM This is an original amp that transforms the sound of a connected electric guitar into the sound of an acoustic guitar.
MIC	Select this if you've connected a microphone.

11 [GAIN] knob

Adjusts the gain (amount of distortion).

12 [VOLUME] knob

Adjusts the volume of the GUITAR/MIC channel.

Common to Both Channels**13 [i-CUBE LINK/AUX IN] knob**

Adjusts the audio volume from the i-CUBE LINK/AUX IN jack, USB port (USB IN) and **Bluetooth**®.

* Note that the CUBE STREET II does not offer Bluetooth functionality. You'll need to attach the BT-DUAL (sold separately) to use Bluetooth (p. 8).

14 [OUTPUT POWER] switch

Changing the setting of this switch changes the maximum volume of the internal speaker and the available operating time on batteries.

Setting	Explanation
MAX	The maximum volume is louder, but the available operating time is shorter.
ECO	The maximum volume is reduced, but the available operating time is longer.

15 LOOPER

You can record up to 90 seconds (in mono) and play back the recorded section over and over. You can also layer additional performances with the recording as it plays back (overdubbing). This lets you play along with your own backing tracks on the fly (p. 7).

* The factory default setting is set to a maximum of 45 seconds (stereo). With the dedicated mobile device app, you can select up to a maximum of 90 seconds (mono). For details, refer to "Wireless Connection with a Mobile Device" (p. 8).

[LOOPER] button

Switches between recording, loop playback, and overdubbing.

[STOP] button

Stops recording or playback.

REC/PLAY/DUB indicator

Indicates the status of the looper.

16 [POWER] switch

Turns the power of this unit on/off.

Rear Panel (Connecting Your Equipment)

* To prevent malfunction and equipment failure, always turn down the volume, and turn off all the units before making any connections.

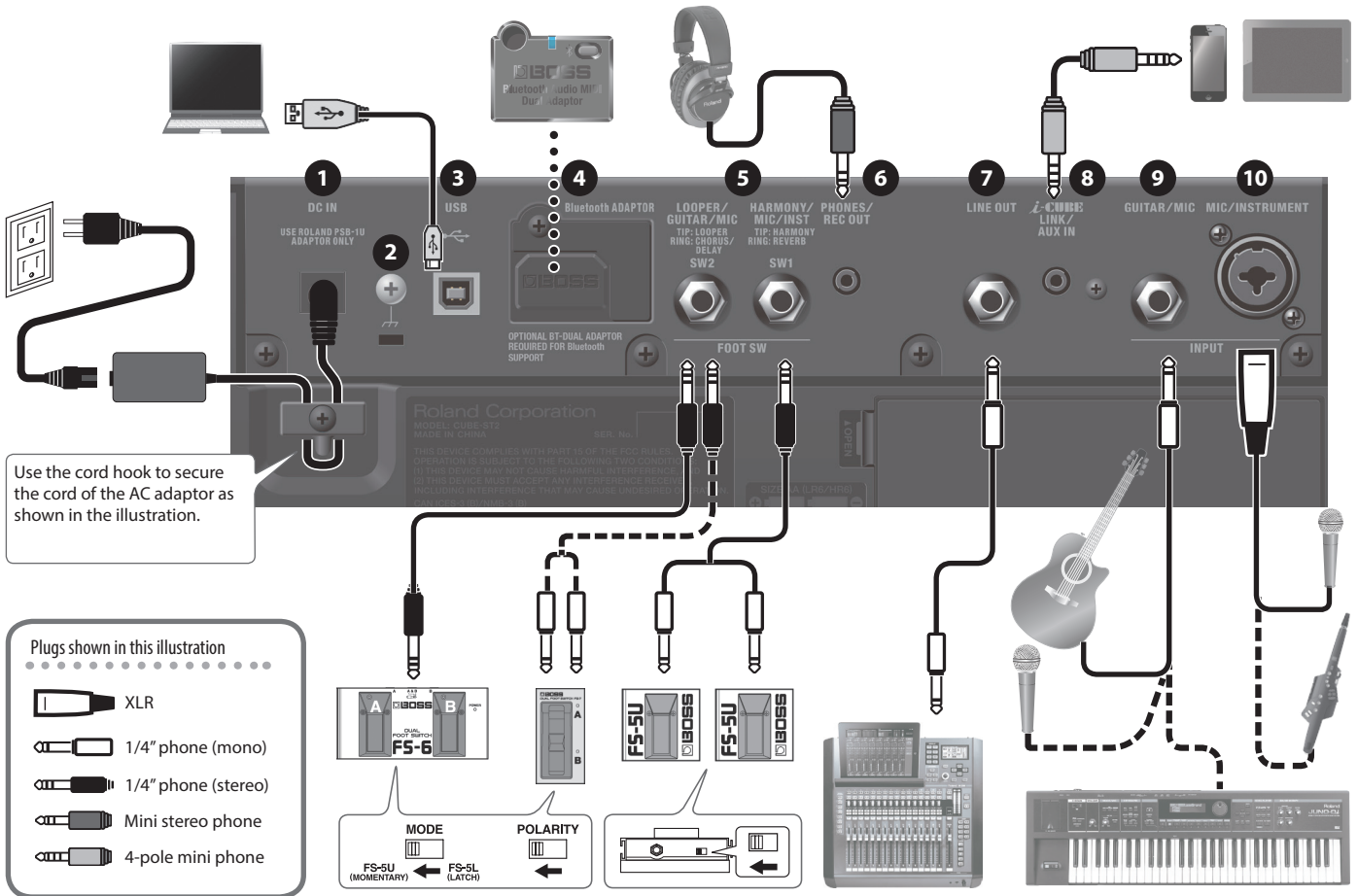

1 DC IN jack

Connect the included AC adaptor to this jack.

* Use only the AC adaptor that came with this unit.

2 Ground terminal

Connect this to an external earth or ground if necessary.

If noise is heard when connecting an external device, connect the ground terminal to reduce the noise.

3 USB port

You can play back and record the sound of this unit using your computer, iPad or iPhone.

Connect these devices using a commercially-available USB B-type adaptor or cable.

The CUBE STREET II uses standard OS drivers. Special drivers are not necessary.

4 Bluetooth ADAPTOR connector

Connect the BT-DUAL (BOSS Bluetooth® Audio MIDI Dual Adaptor, sold separately) to wirelessly play back music from your mobile device like a smartphone or tablet (hereafter "mobile device"), or to edit the effects from a dedicated app on your mobile device (p. 8).

5 FOOT SW

If you connect a footswitch (BOSS FS-6, FS-7, or FS-5U, sold separately), you can use your foot to control LOOPER operations (p. 7), or turn CHORUS, HARMONY and other effects on/off.

* Pin arrangement of LOOPER/GUITAR/MIC jack and HARMONY/MIC/INST jack

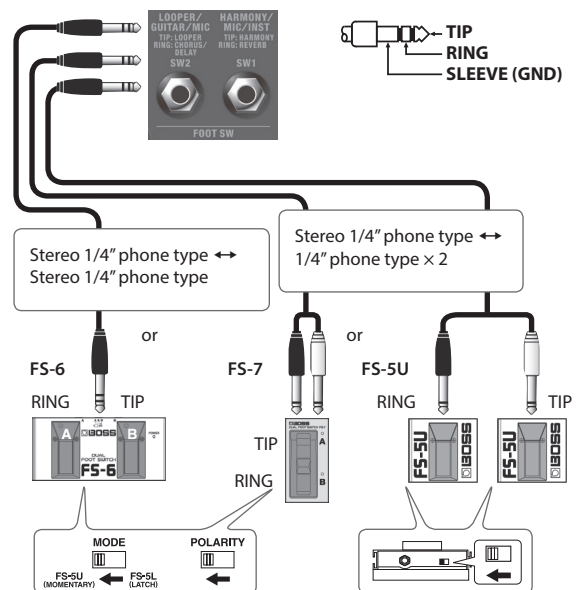

When connected to the LOOPER/GUITAR/MIC jack

SW2		Explanation
TIP	LOOPER	Operates the LOOPER (p. 7).
RING	CHORUS/ DELAY	Turns CHORUS/DELAY (p. 2) on/off.

When connected to the HARMONY/MIC/INST jack

SW1		Explanation
TIP	HARMONY	Turns HARMONY (p. 2) on/off.
RING	MIC/INST	Turns the REVERB (p. 2) for the MIC/INSTRUMENT channel on/off.

6 PHONES/REC OUT jack

Connect your headphones here.

- * No sound is played through the unit's speaker while the PHONES jack is in use.

7 LINE OUT jack

This jack outputs the same sound as the internal speakers of this unit. You can connect an audio interface or recorder to record your playing, or output the sound to a mixer.

Adjust the output level using the [VOLUME] knob.

- * The LINE OUT jack outputs in mono.

8 i-CUBE LINK/AUX IN jack

Connect your audio player or similar device using a stereo mini-plug cable. The sound is output from the speakers of this unit (p. 7). If you use the mini-cable (4-pole) included with this unit to connect to a mobile device, you'll be able to use this unit as an audio interface for your mobile device.

- * Pin arrangement for mini cable (4-pole)

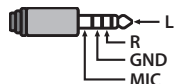

9 GUITAR/MIC jack

Here you can connect an electric guitar, acoustic guitar, an electronic musical instrument like a keyboard, or a mic.

10 MIC/INSTRUMENT jack

Here you can connect a mic, guitar or an electronic musical instrument like a keyboard (balanced connection).

- * Pin assignment of MIC/INSTRUMENT jack

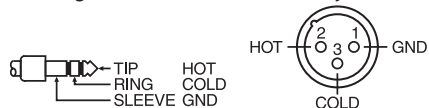

Operating on Battery Power

This unit can be used with either alkaline batteries or Ni-MH batteries. The operating time on batteries depends on the type of batteries you use, and on the setting of the [OUTPUT POWER] switch.

Type of battery	OUTPUT POWER switch	Operating time
Ni-MH batteries	MAX	Approx. 10 hr.
	ECO	Approx. 14 hr.
Alkaline batteries	MAX	Approx. 8 hr.
	ECO	Approx. 11 hr.

- * Times are approximate, and differ depending on the conditions of use.

- * If you handle batteries improperly, you risk explosion and fluid leakage. Make sure that you carefully observe all of the items related to batteries that are listed in "USING THE UNIT SAFELY" and "IMPORTANT NOTES" (the leaflet "USING THE UNIT SAFELY" and the Owner's Manual "USING THE UNIT SAFELY" (p. 12)).
- * When operating on battery power only, the [POWER] switch's indicator blinks when battery power gets too low. Replace the battery as soon as possible.
- * Sounds may distort easily or cut off when played at high volume as the battery power is nearly depleted, but this is not a malfunction. In such instances, replace the batteries or use the AC adaptor included with the unit.

Installing the Batteries

1. Remove the rear panel battery cover.
2. Insert the batteries, making sure they face the right way.

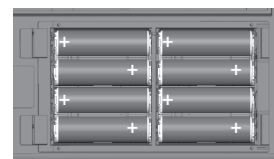

Checking the Remaining Battery Power

1. Hold down the [TUNER] button and turn the power on. The unit enters battery check mode.

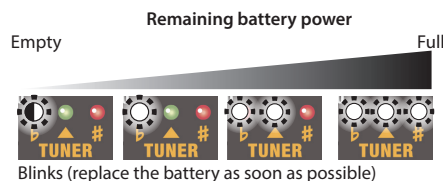

- * The audio coming from the speakers, LINE OUT and PHONES/REC OUT jacks of this unit is muted while the battery power is being checked.
2. When you have finished checking the remaining battery power, press the [TUNER] button again.

Turning the Power On/Off

Before turning the unit on/off, always be sure to turn the volume down. Even with the volume turned down, you might hear some sound when switching the unit on/off. However, this is normal and does not indicate a malfunction.

1. Make sure that the [VOLUME] knob of this unit and the volume settings on all connected devices is set to 0.
2. Turn on the power of this unit.



3. Turn on the power of the devices connected to the LINE OUT and PHONES/REC OUT jacks.
4. Adjust the volume levels of the devices.

- * Before switching off the power, lower the volume on each of the devices in your system and then turn off the power of this unit (the reverse of when you switch this unit on).

Useful Functions

Setting the Harmony Key

Here's how to specify the key used when adding harmony.

1. Press the [KEY] button.

Each press of the button cycles between settings 1 and 2, shown below.

	Indicator	Explanation
-	Unlit	The indicator turns off when harmony is off, or when the harmony is set to "UNISON."
1	Lit green (AUTO)	A harmony is added according to the chords and chord progressions played on the guitar.
2	Lit red (KEY SET)	A harmony is added according to the key that was set using the [AMP TYPE] knob.

Setting the key manually

1. Hold down the [KEY] button to enter key setting mode (the light blinks red).

2. Turn the [AMP TYPE] knob to set the key (C-B).

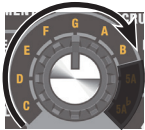

MEMO

When the [KEY] button is blinking, press the [TUNER] button twice to cycle between the three settings shown below.

	Indicator	Explanation
1	♭ blinking	Lowers the harmony by a semitone
2	♯ blinking	Raises the harmony by a semitone
3	▲ blinking	-

* Specify the key of the song that you're singing, referring to below. Ex. If you're singing a song in A minor, set to "C," which is the relative key.

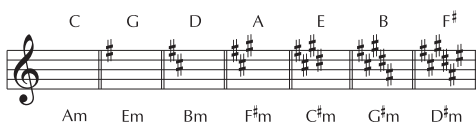
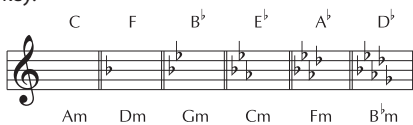

3. Hold down the [KEY] button to exit key setting mode.

* This setting is remembered even when the power is switched off.

Using the Tuner

You can use "chromatic tuning," which automatically determines the closest pitch to that played by the string, or "manual tuning," whereby you select each individual string to tune separately.

* The sound of the MIC/INSTRUMENT and GUITAR/MIC channels are not played from the unit's speakers while you use the tuner function.

Using Chromatic Tuning

1. Press the [TUNER] button.

The [TUNER] button lights to indicate that chromatic tuning mode is in use.

2. Play a single note on the open string you want to tune.

3. Adjust the string's tuning until the green indicator lights.

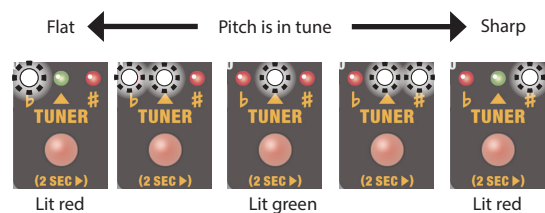

* Reference pitch: A4 = 440 Hz

* The red indicator blinks if the pitch is substantially out of tune.

4. When you have finished tuning, press the [TUNER] button again.

Using Manual Tuning

1. Hold down the [TUNER] button.

The [TUNER] button blinks (the unit enters manual tuning mode).

2. Use the [AMP TYPE] knob to select the name of the string you want to tune, then play a single note on that open string.

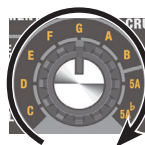

MEMO

When the [TUNER] button is blinking, press the [TUNER] button twice to cycle between the three settings shown below.

	Indicator	Explanation
1	♭ blinking	Tune down a semitone
2	♯ blinking	Tune up a semitone
3	▲ blinking	Regular tuning

* The "5A" setting means the open fifth string on the guitar.

* The "5A ♭" setting means the open fifth string on the guitar, tuned down a semitone.

* Reference pitch: A4 = 440 Hz

3. Adjust the string's tuning until the green indicator lights.

4. When you have finished tuning, press the [TUNER] button again.

Using the Looper

Record standby

Press the [LOOPER] button to enter record standby mode.

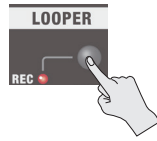

Record

When audio is input, recording starts immediately. Press the [LOOPER] button to play back from the point where you want to loop.

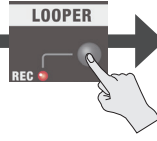

Loop playback

The loop plays back. Pressing the [LOOPER] button switches to overdubbing.

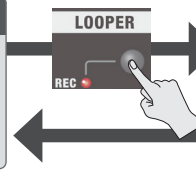

Overdubbing

Record additional layers while playing back the loop. Press the [LOOPER] button to switch to playback.

Stop/clear

To stop, press the [STOP] button.

To clear the phrase, hold down the [STOP] button for at least two seconds while stopped.



- * Once you reach the maximum available recording time, the unit automatically switches to playback mode.
- * Recording/playback is done using the same levels used for each channel during recording.

REC/PLAY indicator display

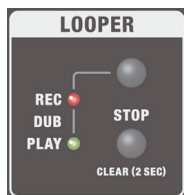

Indicator	Explanation
REC	Blinks while in record standby, lights while recording.
PLAY	Lights up during playback, and blinks when stopped.
DUB (REC+PLAY)	The REC and PLAY indicators light when overdubbing.

Operating the looper with a footswitch

You can also operate the looper by using a footswitch (FS-5U, FS-6 or FS-7, sold separately).

- If a footswitch is connected, recording starts not when audio is input but when you press the footswitch (connected via the plug tip). Playback and overdubbing operations are the same as when using the [LOOP] button.
- If you press the footswitch (connected via the plug tip) twice in one second, the looper stops.
- If you hold down the footswitch (connected via the plug tip) for two seconds or longer, the phrase is cleared.

Using This Unit with Other Mobile Devices (i-CUBE LINK)

With the "i-CUBE LINK" feature, you can use the included mini cable (4-pole) to connect your mobile device, so that audio can be played back from that device while the sound of your guitar playing or mic signal from this unit is sent to the mobile device.

Use this feature to play back or record sound from your guitar or mic to your mobile device, or stream your live performance over the Internet.

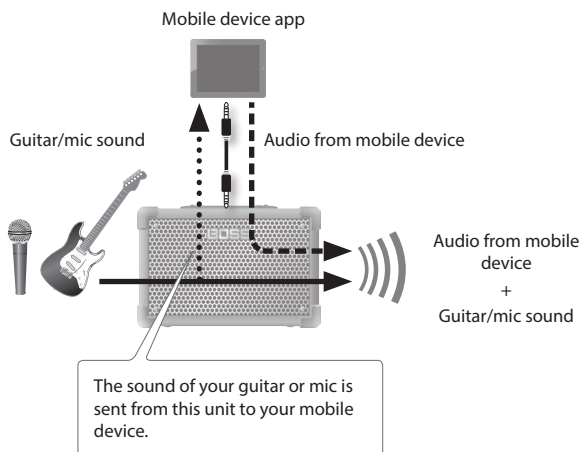

For details on i-CUBE LINK and on mobile device apps that can use i-CUBE LINK, see our website shown below.

<https://www.boss.info/>

Wireless Connection with a Mobile Device

Attach the BT-DUAL (sold separately) to the CUBE STREET II to wirelessly play back music on your mobile device, or to edit the effects of this unit from the app on your mobile device.

* Note that the CUBE STREET II does not offer Bluetooth functionality. You'll need to attach the BT-DUAL (sold separately) to use Bluetooth.

Attaching the BT-DUAL

Attach the BT-DUAL to the Bluetooth ADAPTOR connector of the CUBE STREET II.

1. Power down the CUBE STREET II and unplug the AC adaptor from the AC outlet.
2. Remove the cover and screw from the Bluetooth ADAPTOR connector on the rear panel.

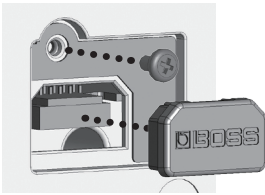

3. Attach the BT-DUAL and fasten the screw that you removed in step 2 in place.

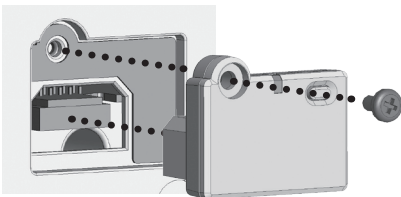

NOTE

- Be sure to use only the screw that was originally mounted on the Bluetooth ADAPTOR connector. If you use a different screw, the unit may malfunction.
- Do not touch any of the printed circuit pathways or connection terminals.
- After you have attached the BT-DUAL, check again whether it is properly installed.

Listening to Sound via Wireless Connection with a Mobile Device

Bluetooth® Audio

With the CUBE STREET II, you can use Bluetooth audio functionality to listen to music or music video played back on a mobile device through this unit's speakers.

Registering a Mobile Device (Pairing)

"Pairing" involves registering the mobile device that you want to use with the CUBE STREET II (making the two devices recognize each other). Here we'll configure the settings so that music data saved on your mobile device can be played wirelessly via the CUBE STREET II.

MEMO

The following explanation is only one example. For details, refer to the owner's manual of your mobile device.

1. Turn on the power of the CUBE STREET II.
2. Place the mobile device that you want to connect close to the CUBE STREET II.
3. Hold down the pairing button on the BT-DUAL until the Bluetooth indicator blinks rapidly.
4. Turn on the Bluetooth function of the mobile device.

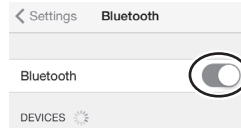

MEMO

This explanation uses the iPhone as an example. For details, refer to the owner's manual of your mobile device.

5. Tap "CUBE-ST2 Audio," shown on the Bluetooth device screen of your mobile device.

This pairs the BT-DUAL with your mobile device. When pairing succeeds, "CUBE-ST2 Audio" is added to the list of "Paired Devices" on your mobile device.

- * If you don't complete the pairing within a certain time, the Bluetooth indicator goes dark and the unit exits pairing standby mode.

Connecting an Already-Paired Mobile Device

1. With the BT-DUAL's Bluetooth indicator off, press the pairing button.
2. Turn on the Bluetooth function of the mobile device.

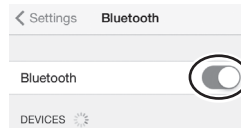

MEMO

- If you were unable to connect using the steps above, tap "CUBE-ST2 Audio," displayed in the Bluetooth device screen of the mobile device.
- To disconnect, press the pairing button on the BT-DUAL to make the Bluetooth indicator go dark, or turn off the mobile device's Bluetooth function.

Adjusting the Volume

1. Adjust the volume on the mobile device.
Adjust the volume of Bluetooth audio.
2. Turn the [i-CUBE LINK/AUX IN] knob on the CUBE STREET II.

The [i-CUBE LINK/AUX IN] knob controls Bluetooth audio, the audio of devices connected to the USB port, and the volume of audio from mobile devices connected to the i-CUBE LINK/AUX IN jack. When you turn the [i-CUBE LINK/AUX IN] knob, this controls both the volume of Bluetooth audio and the volume of the devices connected to each jack.

- * This doesn't change the i-CUBE LINK OUT's volume.

Controlling the CUBE STREET II from a Mobile Device App

Use the “CUBE STREET II Editor” app to edit effects and save settings on this unit.

For details on the CUBE STREET II Editor, see the BOSS website.

<https://www.boss.info/>

Connecting to the App

Here are the settings to make in order to use an app on your mobile device.

* Make the connection from the app's settings, not from your mobile device's Bluetooth settings.

1. Turn on the power of the CUBE STREET II.
2. Place the mobile device that you want to connect close to the CUBE STREET II.
3. Turn on the Bluetooth function of the mobile device.

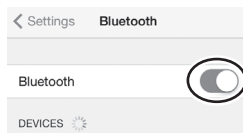

* When connected to Bluetooth audio, the Bluetooth indicator on the BT-DUAL lights up. Note that the unit has not finished connecting with the app at this time.

MEMO

This explanation uses the iPhone as an example. For details, refer to the owner's manual of your mobile device.

4. In the app's settings, connect to CUBE-ST2 MIDI.

NOTE

Do not tap “CUBE-ST2 MIDI” shown in the Bluetooth settings of the mobile device.

Disabling Bluetooth Functionality

If you want to disconnect the Bluetooth connection between the BT-DUAL and your mobile device, disable Bluetooth functionality.

When this unit is not connected to the mobile device via Bluetooth, we recommend you turn off Bluetooth to save on battery power.

1. Press the pairing button on the BT-DUAL.

The Bluetooth indicator goes dark.

Troubleshooting (Troubles with Bluetooth Functionality)

Problem	What to check and do	Page
“CUBE-ST2” does not show up in the Bluetooth device list on my mobile device	The Bluetooth function might be turned off (disabled).	p. 8
Can't connect to Bluetooth audio	If your mobile device's Bluetooth device list shows “CUBE-ST2”	p. 8
	If your mobile device's Bluetooth device list does not show “CUBE-ST2”	
Can't connect to an app	Remove the “CUBE-ST2 MIDI” device first that was registered on your mobile device, turn the mobile device's Bluetooth function off and then back on, and then connect using the settings in the app (CUBE STREET II Editor).	p. 9
In your mobile device's Bluetooth setting screen, you tap “CUBE-ST2 MIDI” but can't connect to the app	Make the connection from the settings of the app (CUBE STREET II Editor), not from your mobile device's Bluetooth settings.	
You pressed the BT-DUAL's pairing button, but can't connect to the app	You cannot connect simply by press the pairing button on the BT-DUAL. In the Bluetooth settings of your mobile device, turn the Bluetooth function on, and then connect from the settings of the app (CUBE STREET II Editor).	
Can't connect to a paired mobile device	If the connection breaks immediately after it is established, turning the mobile device's Bluetooth switch off and then on again may fix the connection.	

MEMO

If you've checked these points and the problem still occurs, please refer to the BOSS support website.

<https://www.boss.info/support/>

Restoring the Factory Settings

Here's how to restore the settings of the to their factory-set condition (factory reset).

MEMO

You can use the CUBE STREET II Editor to back up the settings stored on this unit to your mobile device. To save the settings, back up with the CUBE STREET II Editor.

1. While holding down the [STOP] button, turn the power on.

The REC → PLAY indicators repeatedly blink in sequence. When the blinking stops, all of this unit's settings return to the factory-set state.

NOTE

Don't turn off the power while the factory reset is in progress.

Note when using an already-paired iOS device

After executing a factory reset, you'll need to do the following.

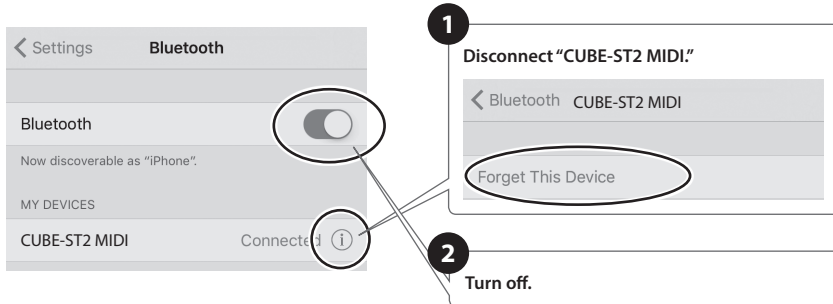

For details, refer to the owner's manual of your iOS device.

Block Diagram

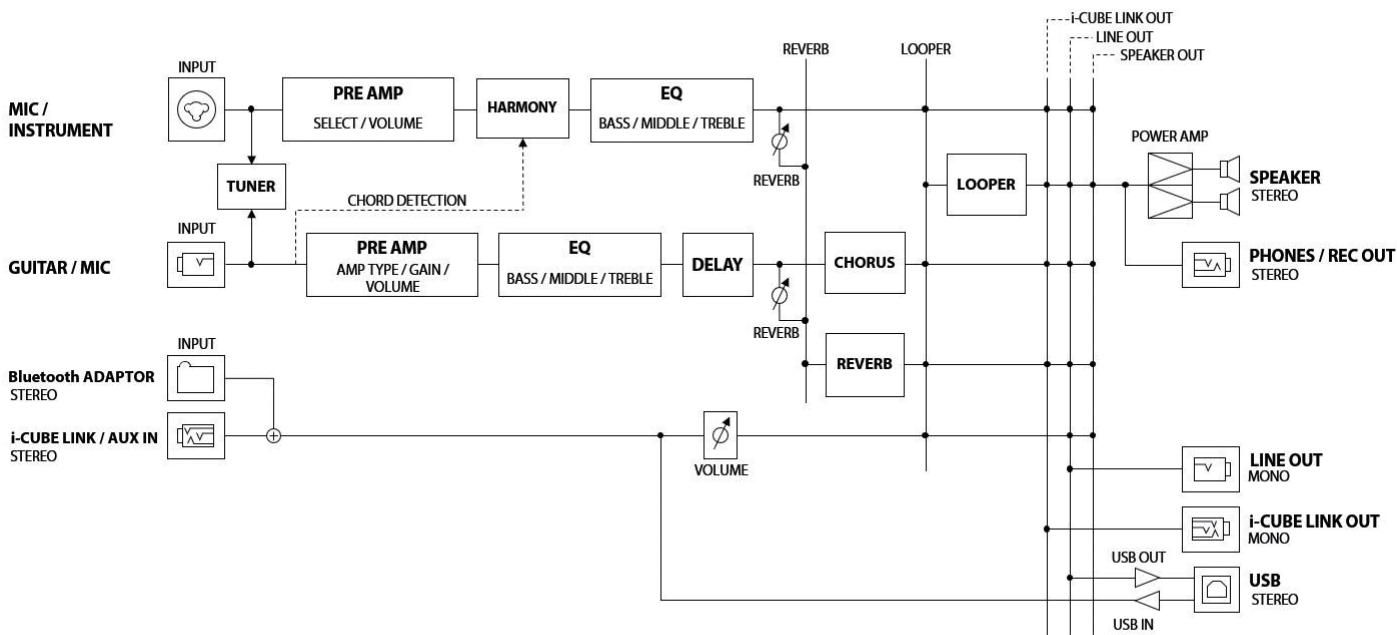

Main Specifications

Rated Power Output	10 W (5 W + 5 W)
Nominal Input Level	MIC/INSTRUMENT INPUT: -40 dBu (2 Ω)/-20 dBu (11 kΩ) GUITAR/MIC INPUT: -10 dBu (1 Ω) i-CUBE LINK/AUX IN: -20 dBu (15 kΩ)
Nominal Output Level	LINE OUT: -10 dBu (MONO)
Speakers	16 cm (6.5 inches) x 2
Controls	[POWER] switch [OUTPUT POWER] switch (MAX, ECO) [LOOPER] button [STOP] button <MIC/INSTRUMENT> [SELECT] switch (MIC, INST) [VOLUME] knob [HARMONY] knob [KEY] button [BASS] knob [MIDDLE] knob [TREBLE] knob [REVERB] knob <TUNER> [TUNER] button <GUITAR/MIC> [AMP TYPE] knob (NORMAL, BRIGHT, WIDE, INSTRUMENT, CLEAN, CRUNCH, LEAD, ACOUSTIC SIM, MIC) [GAIN] knob [VOLUME] knob [BASS] knob [MIDDLE] knob [TREBLE] knob [CHORUS/DELAY] knob (CHORUS, DELAY) [REVERB] knob <i-CUBE LINK/AUX IN> [i-CUBE LINK/AUX IN] knob
Indicators	POWER TUNER KEY REC PLAY
Connectors	<INPUT> MIC/INSTRUMENT jack: Combo type (XLR type, 1/4-inch TRS phone type), balanced GUITAR/MIC jack: 1/4-inch phone type i-CUBE LINK/AUX IN jack: 4-pole miniature phone type <OUTPUT> LINE OUT jack: 1/4-inch phone type PHONES/REC OUT jack: Stereo miniature phone type <FOOT SW> SW 1 HARMONY/MIC/INST jack: 1/4-inch TRS phone type SW 2 LOOPER/GUITAR/MIC jack: 1/4-inch TRS phone type Bluetooth ADAPTOR connector: Dedicated connector USB port: USB B type DC IN jack
Power Supply	AC adaptor (DC 9 V) Alkaline battery (AA, LR6) x 8 Ni-MH battery (AA, HR6) x 8
Current Draw	390 mA

Expected battery life under continuous use	<OUTPUT POWER switch: MAX (Maximum power output: 10 W)> Alkaline battery: Approximately 8 hours Ni-MH battery: Approximately 10 hours (*1) <OUTPUT POWER switch: ECO (Maximum power output: 5 W)> Alkaline battery: Approximately 11 hours Ni-MH battery: Approximately 14 hours (*1) *1 When using batteries having a capacity of 2,500 mAh. * These can vary depending on the specifications of the batteries, capacity of the batteries, and the conditions of use.
Dimensions	414 (W) x 285 (D) x 255 (H) mm 16-5/16 (W) x 11-1/4 (D) x 10-1/16 (H) inches
Weight (excluding AC adaptor)	4.4 kg 9 lbs 12 oz
Accessories	Owner's Manual Leaflet USING THE UNIT SAFELY AC adaptor Power cord Mini cable (4-pole miniature phone type)
Options (sold separately)	BOSS Bluetooth® Audio MIDI Dual Adaptor: BT-DUAL Carrying case: CB-CS1 Footswitch: FS-5U, FS-6, FS-7

* 0 dBu = 0.775 Vrms

* This document explains the specifications of the product at the time that the document was issued. For the latest information, refer to the Roland website.

English

日本語

Deutsch

Français

Italiano

Español

Português

Nederlands

USING THE UNIT SAFELY

WARNING

Use only the supplied AC adaptor and the correct voltage

Be sure to use only the AC adaptor supplied with the unit. Also, make sure the line voltage at the installation matches the input voltage specified on the AC adaptor's body. Other AC adaptors may use a different polarity, or be designed for a different voltage, so their use could result in damage, malfunction, or electric shock.



Use only the supplied power cord

Use only the attached power cord. Also, the supplied power cord must not be used with any other device.



Turn the unit off before installing BT-DUAL

Before installing the BT-DUAL, you must first always turn off the CUBE STREET II and unplug the AC adaptor.



CAUTION

Keep small items out of the reach of children

To prevent accidental ingestion of the parts listed below, always keep them out of the reach of small children.



- Removable Parts
Bluetooth ADAPTOR cover, screw (p. 8)

Handle the ground terminal carefully

If you remove the screw from the ground terminal, be sure to replace it; don't leave it lying around where it could accidentally be swallowed by small children. When refastening the screw, make that it is firmly fastened, so it won't come loose.



Take care not to get burned

Batteries may reach a high temperature; please be careful to avoid burning yourself.



IMPORTANT NOTES

Power Supply

- Place the AC adaptor so the side with the indicator faces upwards. The indicator will light when you plug the AC adaptor into an AC outlet.

Power Supply: Use of Batteries

- Sounds may distort easily or may cut off when played at high volume as the battery power begins to fade, but this is normal and does not indicate a malfunction. In such instances, either replace the batteries or use the AC adaptor included with the unit.
- If operating this unit on batteries, please use alkaline batteries or Ni-MH batteries.

Placement

- Depending on the material and temperature of the surface on which you place the unit, its rubber feet may discolor or mar the surface.

Repairs and Data

- When disposing of the packing carton or cushioning material in which this unit was packed, you must observe the waste disposal regulations that apply to your locality.

Additional Precautions

- Do not use connection cables that contain a built-in resistor.

Intellectual Property Right

- It is forbidden by law to make an audio recording, video recording, copy or revision of a third party's copyrighted work (musical work, video work, broadcast, live performance, or other work), whether in whole or in part, and distribute, sell, lease, perform or broadcast it without the permission of the copyright owner.
- Do not use this product for purposes that could infringe on a copyright held by a third party. We assume no responsibility whatsoever with regard to any infringements of third-party copyrights arising through your use of this product.
- The **Bluetooth**® word mark is registered trademark owned by **Bluetooth** SIG, Inc. and any use of such marks by Roland is under license.
- This product includes third party open source software.
Copyright (c) 2009-2017 ARM Limited. All rights reserved.
Licensed under the Apache License, Version 2.0 (the "License");
You may obtain a copy of the License at <http://www.apache.org/licenses/LICENSE-2.0>
- This Product uses the Source Code of µT-Kernel under T-License 2.0 granted by the T-Engine Forum (www.tron.org).
- Roland and BOSS are either registered trademarks or trademarks of Roland Corporation in the United States and/or other countries.
- Company names and product names appearing in this document are registered trademarks or trademarks of their respective owners.