

KEY FEATURES

- Full range loudspeaker
- Excellent performance/price ratio
- High sensitivity (94 dB)
- Low distortion
- Extended frequency response (up to 15 kHz)
- Designed for all kind of public address applications

TECHNICAL SPECIFICATIONS

Type	Full range loudspeaker
Nominal diameter	200 mm. 8 in.
Rated impedance	8 ohms.
Power capacity	30 w RMS
Sensitivity	94 dB, 1 w @ 1 m
Frequency range	70-15000 Hz

MOUNTING INFORMATION

Overall diameter	205 mm. 8.07 in.
Mounting diameter	180 mm. 7.10 in.
Depth	84 mm. 3.14 in.
Net weight	0.93 kg. 2.05 lb.

MATERIALS

- **Basket:** metal.
- **Cone:** paper.
- **Surround:** paper.
- **Voice coil:** copper.

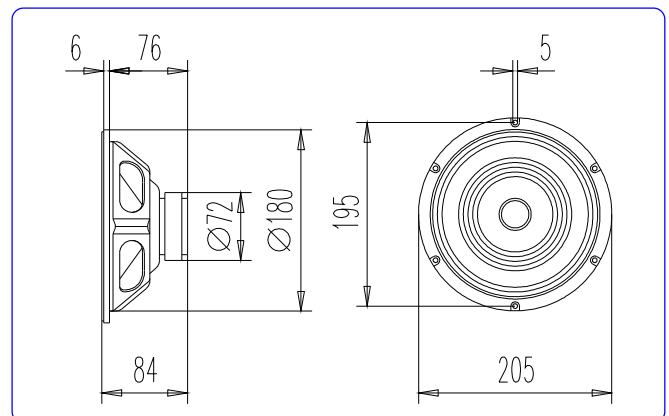
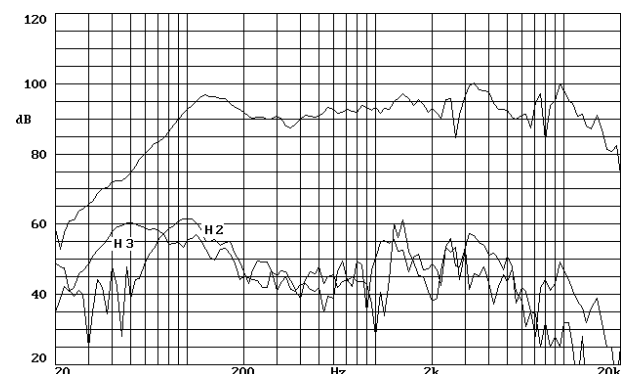
**DIMENSION DRAWINGS****FREQUENCY RESPONSE AND DISTORTION CURVES**

Note: on axis frequency response measured with loudspeaker standing on infinite baffle in anechoic chamber, 1w @ 1m.