

WP205 & WP210

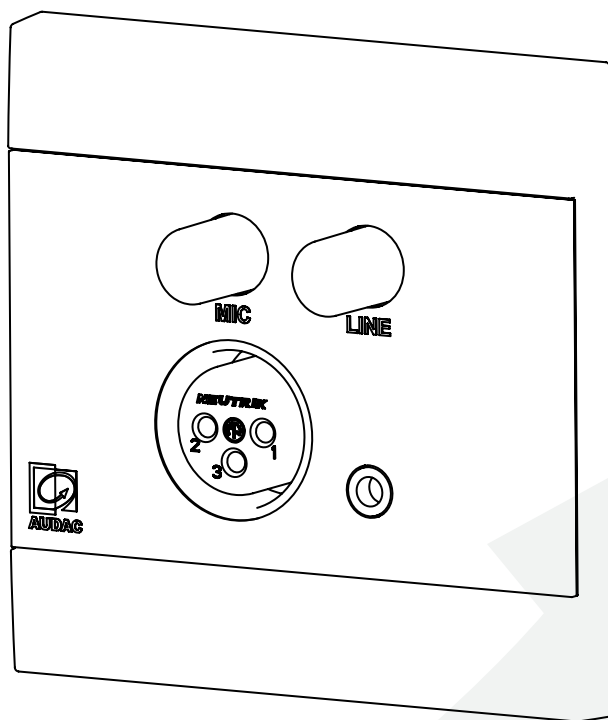

ADDITIONAL INFORMATION

This manual is put together with much care, and is as complete as could be on the publication date. However, updates on the specifications, functionality or software may have occurred since publication. To obtain the latest version of both manual and software, please visit the Audac website @ www.audac.eu.



Table of contents



Introduction	05
Wall panel - Microphone & line receiver	05
Precautions	06
Chapter 1	08
Overview front panel	08
Front panel description	08
Overview rear panel WP205	09
Rear panel description WP205	09
Overview rear panel WP210	010
Rear panel description WP210	010
Chapter 2	011
Quick start guide	011
Chapter 3	012
Connections	012
Technical specifications	014
Notes	015

Wall panel - Microphone & line receiver

The WP205 & WP210 are remote wall mixers. The WP210 can be used with various AUDAC devices, while the WP205 is an external wall mixer designed to be used only with the ARES5A. It converts the signal coming from a stereo line-level audio source (such as a tuner, mobile devices, ...) or balanced microphone at the level corresponding to the differential signal input making it possible to transfer high-quality audio over long distances between the wall panel and the loudspeaker, by just using inexpensive twisted-pair CAT5e or better cabling. On the front side of the wall panel, there is a 3.5 mm jack stereo line input connection available together with a balanced XLR microphone input, both provided with their own knob which allows the signals to be mixed together. The wall panels are available in 2 colours and is compatible with most standard EU (80x80 mm) style in-wall boxes for solid and hollow walls. With the Elegant front panel, it will blend into any environment

READ FOLLOWING INSTRUCTIONS FOR YOUR OWN SAFETY

ALWAYS KEEP THESE INSTRUCTIONS. NEVER THROW THEM AWAY

ALWAYS HANDLE THIS UNIT WITH CARE

HEED ALL WARNINGS

FOLLOW ALL INSTRUCTIONS

NEVER EXPOSE THIS EQUIPMENT TO RAIN, MOISTURE, ANY DRIPPING OR SPLASHING LIQUID. AND NEVER PLACE AN OBJECT FILLED WITH LIQUID ON TOP OF THIS DEVICE

NO NAKED FLAME SOURCES, SUCH AS LIGHTED CANDLES, SHOULD BE PLACED ON THE APPARATUS

DO NOT PLACE THIS UNIT IN AN ENCLOSED ENVIRONMENT SUCH AS A BOOKSHELF OR CLOSET. ENSURE THERE IS ADEQUATE VENTILATION TO COOL THE UNIT. DO NOT BLOCK THE VENTILATION OPENINGS.

DO NOT STICK ANY OBJECTS THROUGH THE VENTILATION OPENINGS.

DO NOT INSTALL THIS UNIT NEAR ANY HEAT SOURCES SUCH AS RADIATORS OR OTHER APPARATUS THAT PRODUCE HEAT

DO NOT PLACE THIS UNIT IN ENVIRONMENTS WHICH CONTAIN HIGH LEVELS OF DUST, HEAT, MOISTURE OR VIBRATION

THIS UNIT IS DEVELOPED FOR INDOOR USE ONLY. DO NOT USE IT OUTDOORS

PLACE THE UNIT ON A STABLE BASE OR MOUNT IT IN A STABLE RACK

ONLY USE ATTACHMENTS & ACCESSORIES SPECIFIED BY THE MANUFACTURER

UNPLUG THIS APPARATUS DURING LIGHTNING STORMS OR WHEN UNUSED FOR LONG PERIODS OF TIME

ONLY CONNECT THIS UNIT TO A MAINS SOCKET OUTLET WITH PROTECTIVE EARTHING CONNECTION

THE MAINS PLUG OR APPLIANCE COUPLER IS USED AS THE DISCONNECT DEVICE, SO THE DISCONNECT DEVICE SHALL BE READILY OPERABLE

USE THE APPARATUS ONLY IN MODERATE CLIMATES



CAUTION - SERVICING

This product contains no user serviceable parts. Refer all servicing to qualified service personnel. Do not perform any servicing (unless you are qualified to)



EC DECLARATION OF CONFORMITY

This product conforms to all the essential requirements and further relevant specifications described in following directives: 2014/30/EU (EMC) & 2014/35/EU (LVD).



WASTE ELECTRICAL AND ELECTRONIC EQUIPMENT (WEEE)

The WEEE marking indicates that this product should not be disposed with regular household waste at the end of its life cycle. This regulation is created to prevent any possible harm to the environment or human health.

This product is developed and manufactured with high quality materials and components which can be recycled and/or reused. Please dispose this product at your local collection point or recycling centre for electrical and electronic waste. This will make sure that it will be recycled in an environmentally friendly manner, and will help to protect the environment in which we all live.

Overview front panel

On the front side of the wall panel, there is an unbalanced 3.5 mm jack stereo line input connection available together with a balanced XLR microphone input, both provided with their own knob which allows the signals to be mixed together.

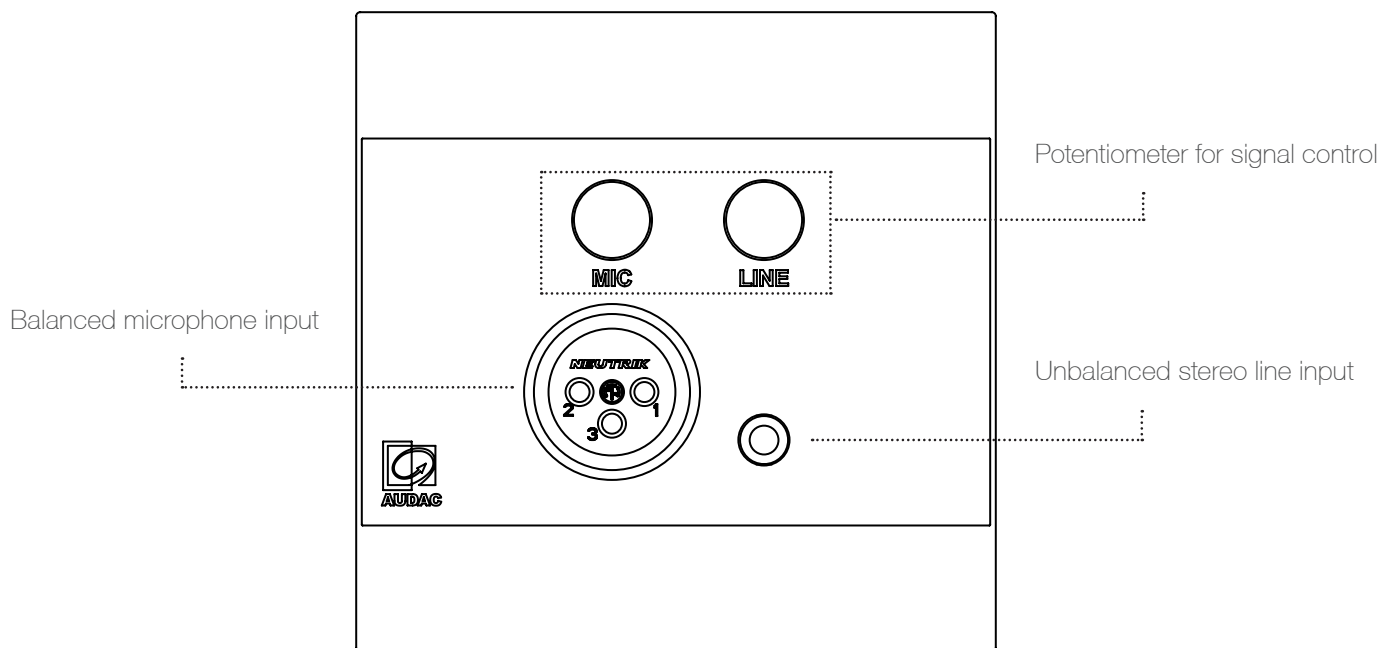

Front panel description

Balanced microphone input

A balanced microphone can be connected to this XLR input connector. For powering condenser microphones, phantom power can be enabled.

Unbalanced line input

An unbalanced stereo audio source can be connected to this 3.5mm jack stereo line input.

Potentiometers for signal control

The individual signal levels for the line and microphone inputs can be adjusted with these potentiometers. This feature allows for the signals to be mixed together.

Overview rear panel WP205

The rear side of the WP205 contains an 8-pin Terminal Block connector. Below of the 8-pin connector are some DIP switches. With these switches certain functions can be switched on or off depending on the situation where the WP is in.

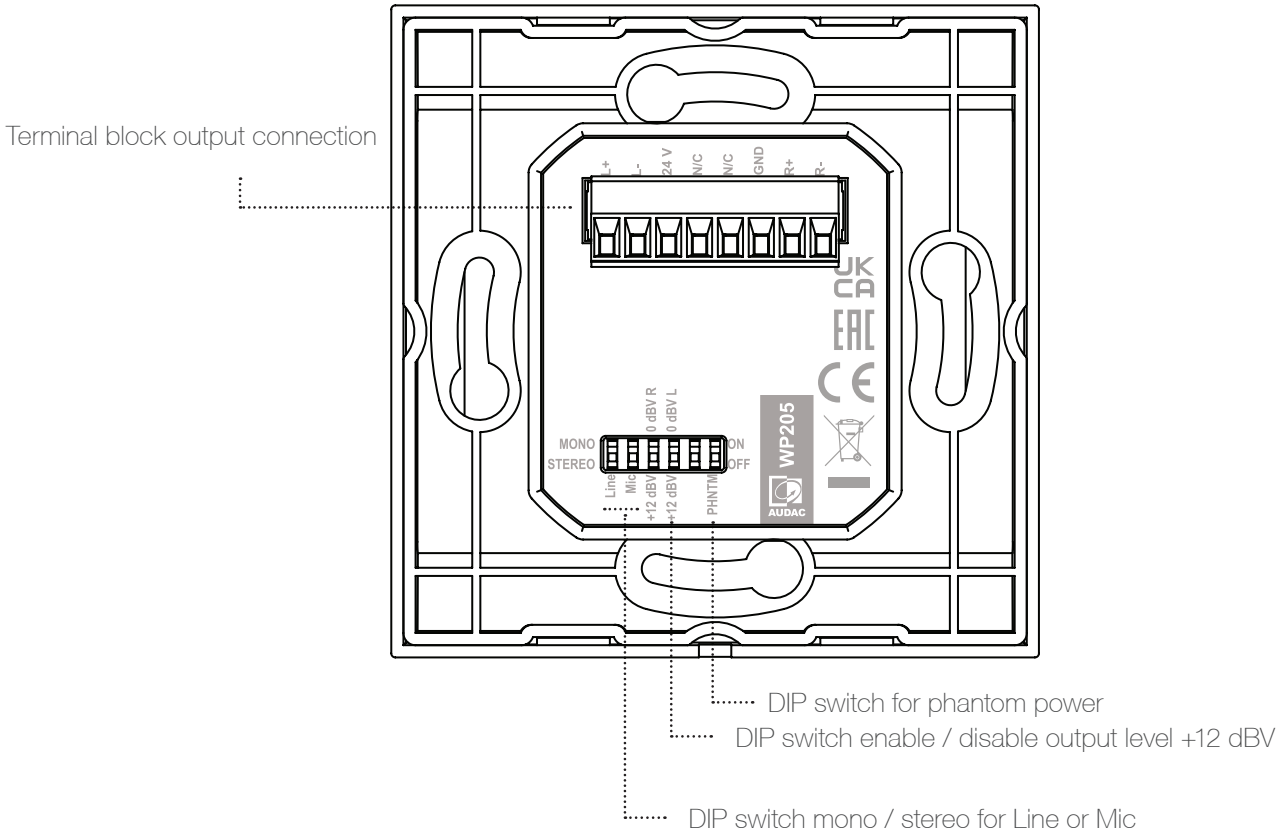

Rear panel description WP205

8-pin terminal block (3.81 mm pitch) output connection

The rear of the WP205 contains an 8-pin Euro-Terminal Block connector. For more information on how to make the connections can be found under "Connecting" in Chapter 3 of this manual.

DIP switches

DIP switch enable / disable output level +12 dBV: When the option of +12 dBV is enabled, the wall panel is compatible with remote input devices. When it is disabled, the wall panel is compatible with standard line inputs (0 dBV)

DIP switch mono / stereo: With this switch, the operation mode can be switched between mono and stereo mode for the Line or Mic signal. When the wall panel is used in mono mode, the input signal applied to the left input signal will be available on both left and right outputs.

DIP switch enable / disable phantom power: The phantom power for the microphone input can be enabled or disabled.

Overview rear panel WP210

The rear of the WP210 contains an 8-pin Terminal Block connector, which is used to connect the wall panel to the RJ45 connector. Below the 8-pin connector is a 6-pin connector. This input connector is a duplicate of the line and mic input but for permanent connections. Below of the 6-pin connector are some DIP switches. These switches allow certain functions to be turned on or off, depending on the situation the WP is in.

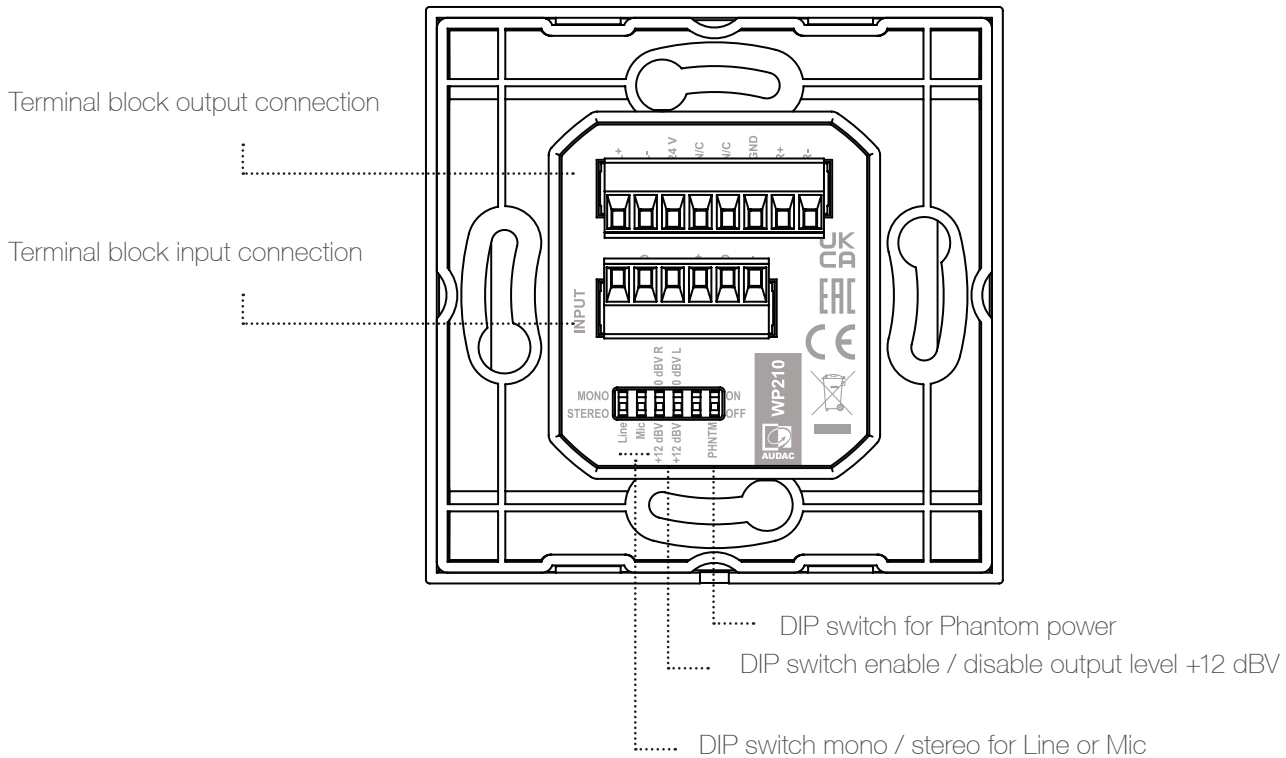

Rear panel description WP210

8-pin terminal block (3.81 mm pitch) output connection

The rear of the WP210 contains an 8-pin Euro-Terminal Block connector, where the wall panel must be connected to the RJ45 connector. For more information on how to make the connections can be found under "Connecting" in Chapter 3 of this manual.

6-pin terminal block (3.81 mm pitch) input connection

The 6-pin Euro-Terminal block is an input connector. This is a duplicate of the mic and line inputs but for a permanent connection.

DIP switches

DIP switch enable / disable phantom power: The phantom power for the microphone input can be enabled or disabled.

DIP switch enable / disable output level +12 dBV: When the option of +12 dBV is enabled, the wall panel is compatible with remote input devices. When it is disabled, the wall panel is compatible with standard line inputs (0 dBV)

DIP switch mono / stereo: The operation mode can be switched between mono and stereo mode with this switch. When the wall panel is used in mono mode, the input signal applied to the left input signal will be available on both left and right outputs.

Chapter 2

Quick start guide

This chapter guides you through the setup process for a basic setup where a WP205 or 210 should be connected to a loudspeaker system with wired network. Install your wall panel on the desired location by means of the optional available WB45S/FS (for solid walls) or WB45S/FG (for hollow walls) installation boxes. Provide a twisted pair cable (CAT5E or better) from the receiving device to the wall panel.

Connect the 8-pin terminal block to a receiving device with a twisted pair cable. After all those connections are made, just plug-in the connectors of the twisted pair cable, plug in the mains power on the loudspeaker side and your system is ready for operation.

You can plug in your line and microphone audio sources to the wall-panel, and your sounds should be audible through the system.

Connecting multiple ARES sets to a single remote input

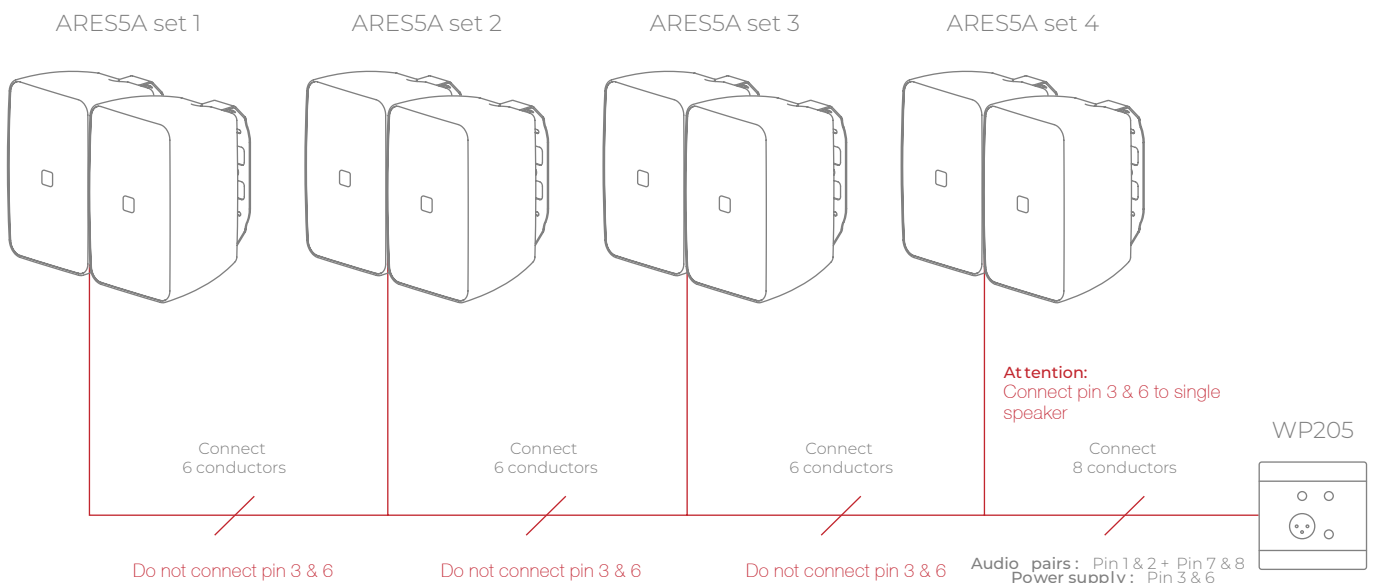

Connecting a remote input to a line input connection



WP2xx series

PRE116

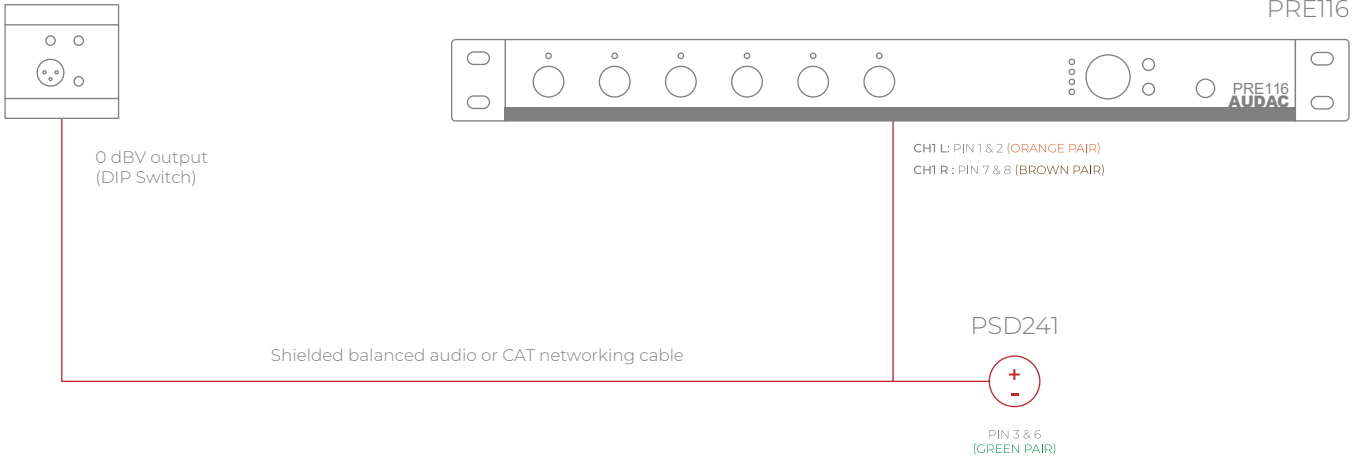

Chapter 3

Connections

CONNECTION STANDARDS

The in- and output connections for AUDAC audio equipment are performed according to international wiring standards for professional audio equipment

3.5 mm jack:

For unbalanced line input connections

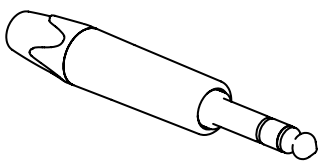

Tip: Left
Ring: Right
Sleeve: Ground

XLR

For balanced line input connections

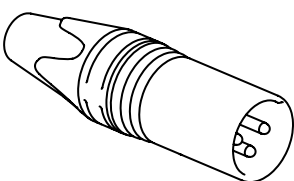

PIN 1: Ground
PIN 2: Signal +
PIN 3: Signal -

Wall panel rear audio input connection:

6-pin terminal block connector (3.5mm pitch)

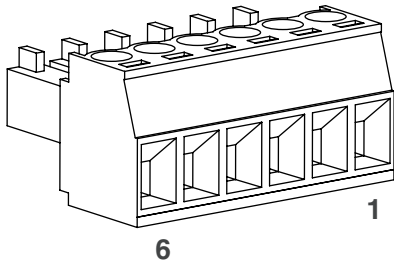

PIN 1:	Mic -
PIN 2:	GND
PIN 3:	Mic +
PIN 4:	Line L
PIN 5:	GND
PIN 6:	Line R

Terminal block (Audio, +24V DC)

For connection to Wall Panels

The 8-pin Euro-Terminal Block on the rear side of the WP205 or WP210 should be connected to twisted pair cabling. The maximum cable distance between the input unit and the speaker system can reach up to 100 meter. To ensure a proper working of the system, all 8 conductors of the twisted pair cable have to be connected according to the table below.

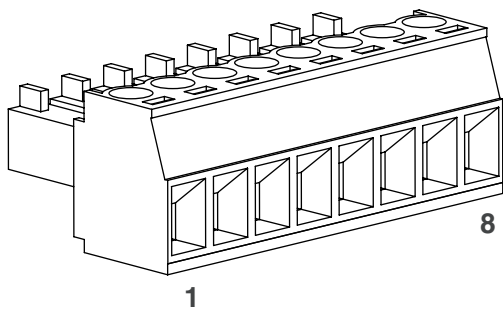

Pin 1	White-Orange	Left +
Pin 2	Orange	Left -
Pin 3	White-Green	+24V DC
Pin 4	Blue	Not connected
Pin 5	White-Blue	Not connected
Pin 6	Green	GND
Pin 7	White-Brown	Right +
Pin 8	Brown	Right -

Technical specifications



Inputs	Type	Stereo unbalanced line
	Connector	Front: 3.5mm jack Rear: 6-pin terminal block 3.81mm (for WP210 only)
	Impedance	7,7 kOhm
	Sensitivity	-6 dBV / +26 dBV
	THD+N	<0,2%
	Signal / Noise	72 dB
	Type	Balanced microphone
	Connector	Front: female XLR Rear: 6-pin terminal block 3.81mm (for WP210 only)
	Impedance	1 kOhm
	Sensitivity	-45 dBV / -10 dBV
	THD+N	<0,02%
	Signal / Noise	> 75 dB
Output	Type	Stereo
	Connector	8-pin terminal block 3.81mm
	Output level	Switch between 0dBV and 12 dBV
Power consumption		< 1,5W
Power supply		17V - 24V
Phantom power		24V DC (depending on input voltage)
Noisefloor		-76.5 dBV
Dimensions		80 x 80 x 52.7 mm (W x H x D)
Built-In depth		47 mm
Colours		Black (RAL9005)
		White (RAL9003)
Front finish		ABS with glass
Accessories	Solid wall	WB45S/FS
	Hollow wall	WB45S/FG
Compatible devices		ARES5A
		MTX48 / MTX88
		AMP523
		APG20



Discover more on audac.eu