

ARES5A

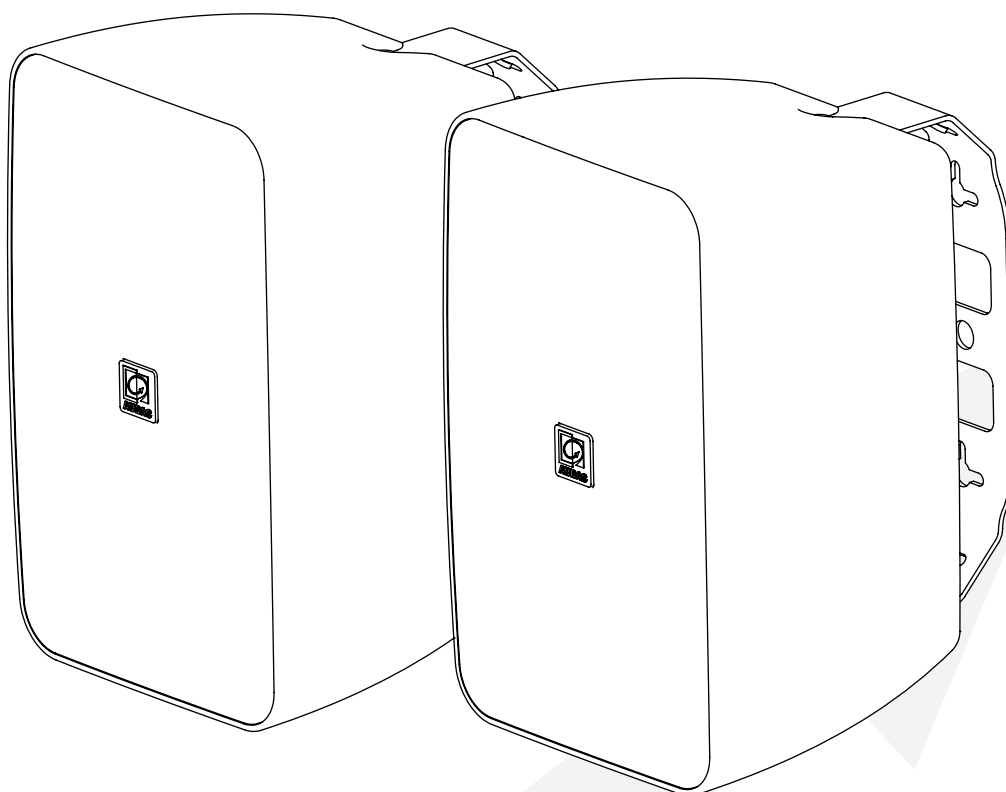

ADDITIONAL INFORMATION

This manual is put together with much care, and is as complete as could be on the publication date. However, updates on the specifications, functionality or software may have occurred since publication.

Introduction	05
Active speaker system	05
Precautions	06
Chapter 1	08
Connections and connectors	08
Chapter 2	09
Overview ARES5A: Rear	09
Overview ARES5: passive	010
Chapter 3	011
Placement and mounting	011
Technical specifications	013
Notes	014

Active speaker system

The ARES5A is a 2-way active speaker system consisting of an active and passive unit to be linked with each other. It offers an easy and flexible solution for a wide variation of applications, producing a clear and powerful sound.

The integrated amplifier can deliver a power of 2 x 40 Watt and includes a stereo line input which is implemented balanced and unbalanced, allowing convenient connection to any kind of audio source. Unbalanced audio sources are connected through a 3.5 mm jack connector, while balanced sources can be connected to the terminal block input connection allowing long signal runs without interference. A volume potentiometer allows the user to adjust the level of loudness while the two-band tone control allows equalization of treble and bass. The auto-standby mode reduces the power consumption when no input signal is detected. The active speaker includes an stereo amplifier module, also delivering the input signal to the passive unit.

A special designed bracket systems allows close to wall installation of the speakers, while the recessed bracket structure guarantees an optimal cosmetic outlook of the system.

A remote input connection implemented trough an RJ45 connector allows wall panel connections, allowing expansion of the system through remote input modules. A variation of optional remote input units with different input possibilities is available.

Precautions



READ FOLLOWING INSTRUCTIONS FOR YOUR OWN SAFETY

ALWAYS KEEP THESE INSTRUCTIONS. NEVER THROW THEM AWAY

ALWAYS HANDLE THIS UNIT WITH CARE

HEED ALL WARNINGS

FOLLOW ALL INSTRUCTIONS

NEVER EXPOSE THIS EQUIPMENT TO RAIN, MOISTURE, ANY DRIPPING OR SPLASHING LIQUID. AND NEVER PLACE AN OBJECT FILLED WITH LIQUID ON TOP OF THIS DEVICE

NO NAKED FLAME SOURCES, SUCH AS LIGHTED CANDLES, SHOULD BE PLACED ON THE APPARATUS

DO NOT PLACE THIS UNIT IN AN ENCLOSED ENVIRONMENT SUCH AS A BOOKSHELF OR CLOSET. ENSURE THERE IS ADEQUATE VENTILATION TO COOL THE UNIT. DO NOT BLOCK THE VENTILATION OPENINGS.

DO NOT STICK ANY OBJECTS THROUGH THE VENTILATION OPENINGS.

DO NOT INSTALL THIS UNIT NEAR ANY HEAT SOURCES SUCH AS RADIATORS OR OTHER APPARATUS THAT PRODUCE HEAT

DO NOT PLACE THIS UNIT IN ENVIRONMENTS WHICH CONTAIN HIGH LEVELS OF DUST, HEAT, MOISTURE OR VIBRATION

THIS UNIT IS DEVELOPED FOR INDOOR USE ONLY. DO NOT USE IT OUTDOORS

PLACE THE UNIT ON A STABLE BASE OR MOUNT IT IN A STABLE RACK

ONLY USE ATTACHMENTS & ACCESSORIES SPECIFIED BY THE MANUFACTURER

UNPLUG THIS APPARATUS DURING LIGHTNING STORMS OR WHEN UNUSED FOR LONG PERIODS OF TIME

ONLY CONNECT THIS UNIT TO A MAINS SOCKET OUTLET WITH PROTECTIVE EARTHING CONNECTION

THE MAINS PLUG OR APPLIANCE COUPLER IS USED AS THE DISCONNECT DEVICE, SO THE DISCONNECT DEVICE SHALL BE READILY OPERABLE

USE THE APPARATUS ONLY IN MODERATE CLIMATES

CAUTION

The symbols shown are internationally recognized symbols that warn about potential hazards of electrical products. The lightning flash with arrow point in an equilateral triangle means that the unit contains dangerous voltages. The exclamation point in an equilateral triangle indicates that it is necessary for the user to refer to the users manual.



These symbols warn that there are no user serviceable parts inside the unit. Do not open the unit. Do not attempt to service the unit yourself. Refer all servicing to qualified personnel. Opening the chassis for any reason will void the manufacturer's warranty. Do not get the unit wet. If liquid is spilled on the unit, shut it off immediately and take it to a dealer for service. Disconnect the unit during storms to prevent damage.



CAUTION - SERVICING

This product contains no user serviceable parts. Refer all servicing to qualified service personnel. Do not perform any servicing (unless you are qualified to)



EC DECLARATION OF CONFORMITY

This product conforms to all the essential requirements and further relevant specifications described in following directives: 2014/30/EU (EMC) and 2014/35/EU (LVD)



WASTE ELECTRICAL AND ELECTRONIC EQUIPMENT (WEEE)

The WEEE marking indicates that this product should not be disposed with regular household waste at the end of its life cycle. This regulation is created to prevent any possible harm to the environment or human health.

This product is developed and manufactured with high quality materials and components which can be recycled and/or reused. Please dispose this product at your local collection point or recycling centre for electrical and electronic waste. This will make sure that it will be recycled in an environmentally friendly manner, and will help to protect the environment in which we all live.

Connections and connectors

CONNECTION STANDARDS

The in- and output connections for AUDAC audio equipment are performed according to international wiring standards for professional audio equipment

3-Pin Terminal block:

For unbalanced line input connections

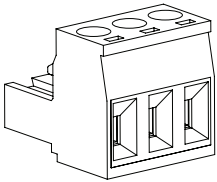

Left: Signal - (XLR Pin 3)
Center: Signal + (XLR Pin 2)
Right: Ground (XLR Pin 1)

For balanced signal input connections

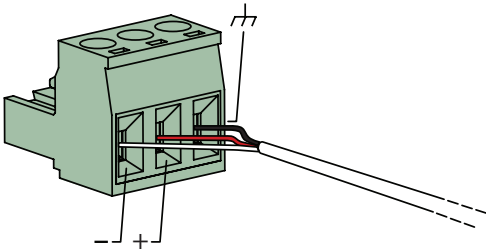

For unbalanced signal input connections

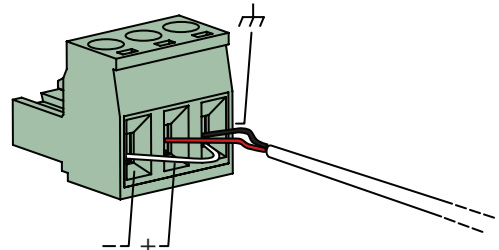

3.5 mm jack:

For unbalanced line input connections

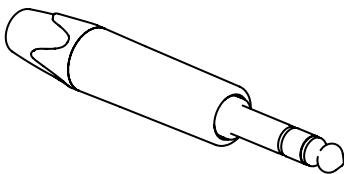

Tip: Left
Ring: Right
Sleeve: Ground

RJ45 (Audio, +24V DC)

Remote input units

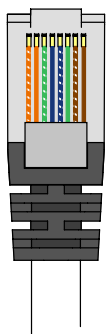

Pin 1	White-Orange	Left channel +
Pin 2	Orange	Left channel -
Pin 3	White-Green	+24V DC
Pin 4	Blue	Not connected
Pin 5	White-Blue	Not connected
Pin 6	Green	GND
Pin 7	White-Brown	Right channel +
Pin 8	Brown	Right channel -

Overview ARES5A: Rear

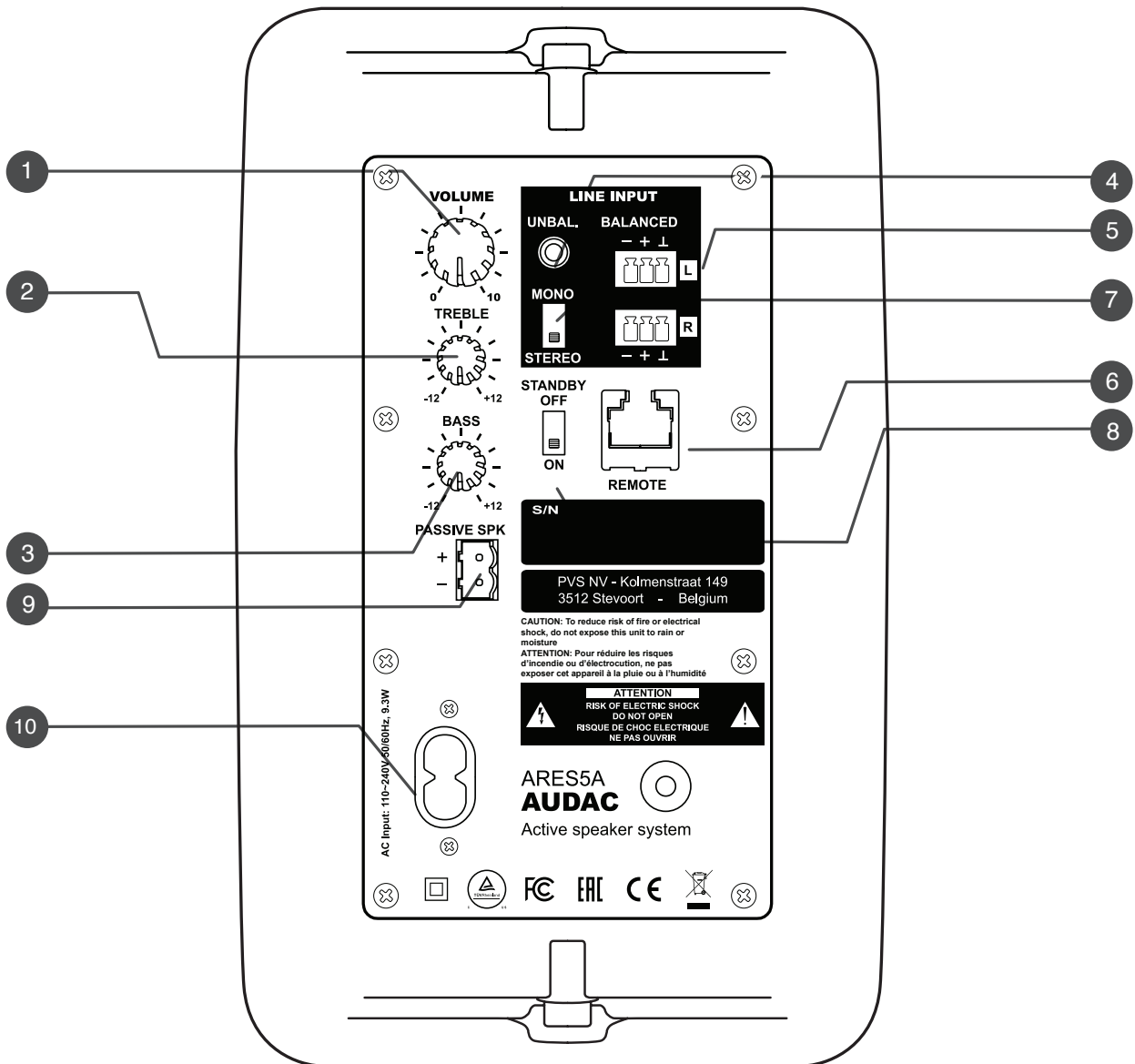

1) Volume control

This button controls the general volume of the speaker system.

2) Treble control

This button allows you to increase or decrease the high frequencies by 12 dB. By adding high frequencies, the intelligibility can be improved. In the center position, the sound is neutral. You can adjust it to the desired level.

3) Bass control:

By adding bass, you can add warmth to your music. Decreasing bass can improve the intelligibility of spoken messages, certainly in reverberant rooms. These values can be increased or decreased by 12 dB

4) Unbalanced line input 3.5mm:

The audio source from a portable device like a laptop, a phone, ... can be connected to this unbalanced line input. The applied signal should be a line-level signal.

5) Balanced line input:

These inputs can be used when connecting source devices with a balanced output signal. The balanced input connections are performed using three-pin Terminal block connectors. Balanced signals are less sensitive for interference caused by external devices. For this reason is balanced wiring recommended when using long cable runs between the source device and the speakers, or when installed in areas where a lot of interference occurs.

6) Remote connector:

Remote input units can be connected to this RJ45 input connector. For more information about compatible devices and further information about pinouts, cable runs and technical possibilities, check additional documentation on our websites or from the optional accessories.

7) Stereo/mono switch:

This switch allows the operation mode to be switched between mono and stereo mode. When the speaker is operated in mono, the left and right input signals will be mixed and fed to the amplifier.

8) Standby switch:

In normal operation, the speaker switches to standby mode after ~20 minutes of inactivity (no signal detection). It automatically wakes-up in presence of an input signal. This switch allows to enable & disable the auto standby mode in situations where this behavior is not desirable. When switched ON, the power LED illuminates in blue color, while orange when switched to standby.

9) Speaker output:

This two pin terminal block connector should be used to connect the supplied passive loudspeaker. Using other loudspeakers can give bad results and even cause damage to the main unit. Be sure that the polarity of the speakers is correct.

10) Power supply socket:

The unit should be connected to the mains circuit by using a standard IEC C7/C8 power cord.

Overview ARES5: passive

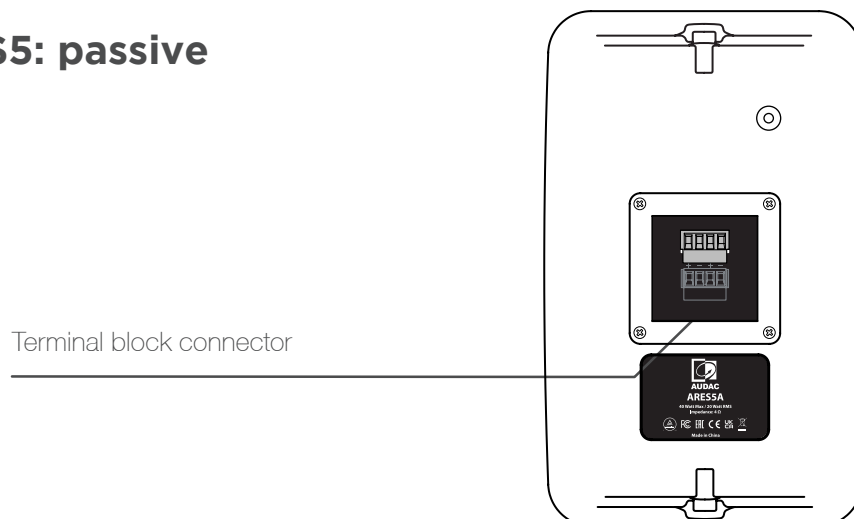

Placement and mounting

The ARES5A has to be fixed to the wall by two screws and plugs. Two screws and plugs are supplied, but should be selected depending on the mounting surface. The screws are fitted into the provided slots of the bracket. The shape of the slots allows the screws to be inserted into the wall first, after which the speaker is suspended. There are three different mounting possibility's for the ARES5A: horizontally, vertically or corner. Make sure the appropriate fasteners are used, depending on the mounting surface (brick, concrete, wood, ...)

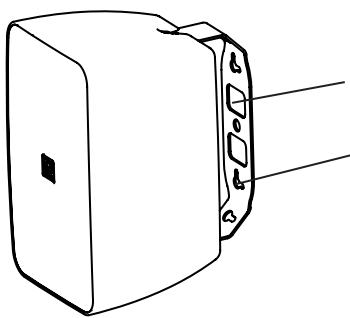

1) Vertical mounting

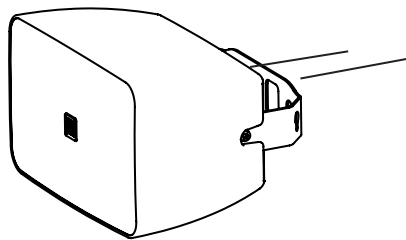

2) Horizontal mounting

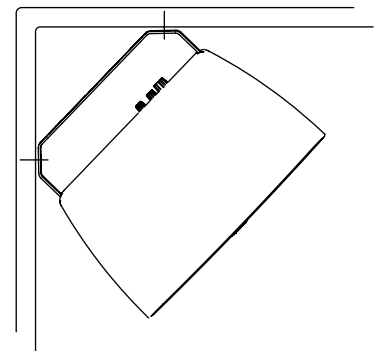

3) Corner mounting

Inclination angle

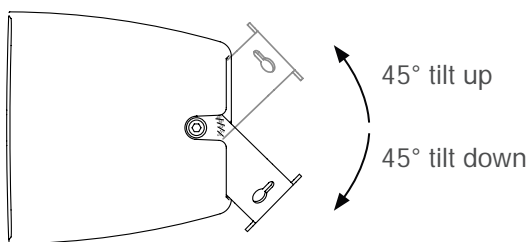

Installation dimensions

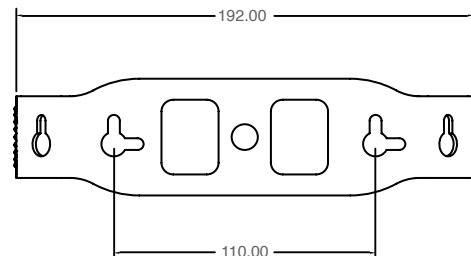

Installation

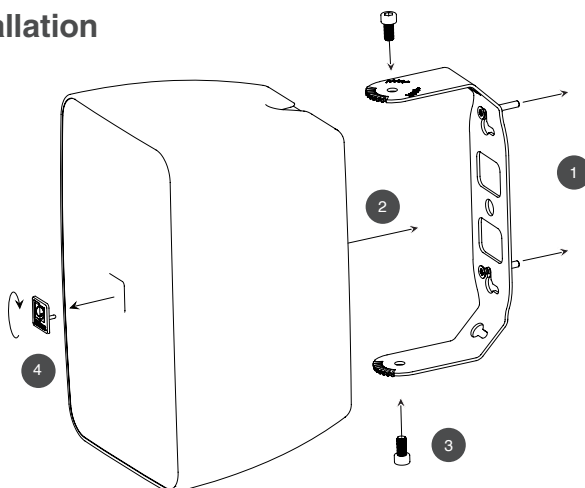

- 1: Attach the bracket to the mounting surface
- 2: Insert the bracket in the provided slots in the cabinet and tighten the two bolts
- 3: Fix the ARES in the preferred position
- 4: Adjust the AUDAC logo into the correct position by pulling and rotating it.

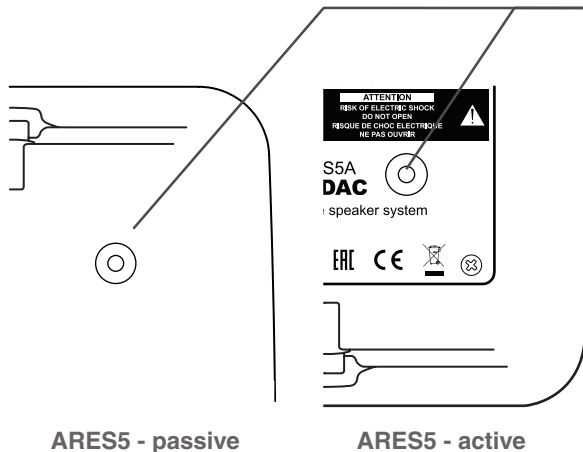

ARES5 - passive

ARES5 - active

Drop safety bushing

The ARES5 has a M6 safety bushing. This provides the option of mounting drop safety wires. Please check your local regulations if this is required.

ATTENTION

- Installation must be carried out by qualified personnel only.
- Incorrect assembly can result in severe personal injury and property damage (if you intend to install this product yourself, you must check for installations such as electrical wiring and plumbing that may be buried inside the wall).
- It is the installer's responsibility to verify that the wall will safely support the total load of the unit and wall brackets.
- Additional tools (not included) are required for the installation.
- Do not over tighten screws.
- Keep this instruction manual for future reference.

Remote input connector

It is optional to connect the ARES5A to a remote input unit. The connection is made using a CAT cable, whereby the minimum requirement for the connection is a CAT5E. The signal strength, with the use of a CAT5E cable, is strong enough up to a length of 100 meters. The power to the wall panel is distributed from the speaker. Check www.audac.eu for all compatible devices.

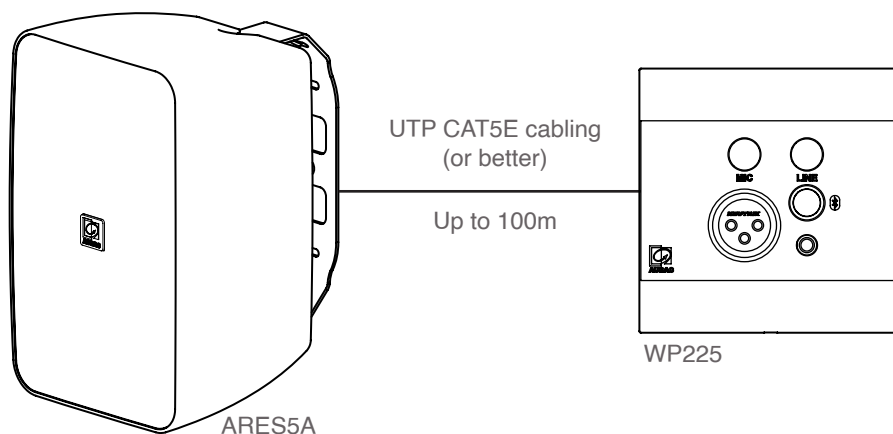

Technical specifications



Frequency response	80 Hz - 20 kHz	
Sensitivity (1W / 1m)	89dB	
Sound pressure (Max W / 1m)	105dB	
RMS Power	2 x 20 Watt	
MAX Power	2 x 40 Watt	
Drivers	HF	0.5" Mylar tweeter
	LF	5 1/4" Polypropylene woofer
Dispersion	Horizontal	210°
	Vertical	205°
Construction	Cabinet	ABS
	Bracket	Powder coated steel
Power consumption	Standby	0.35 W
	Idle	3.1 W
	1/8 output power	11.3 W
	1/3 output power	17 W
Connectors	Power	IEC C7/C8 input connector
	Input	Unbalanced (3.5 mm jack)
		Balanced (3.081mm 3-pin Terminal block)
		Remote connector (RJ45)
	Speaker output	2-pin 5.08mm Terminal block
Controls	2-band tone control	
	Volume control	
Colors	White (RAL9003)	
	Black (RAL9005)	
Dimensions	150 x 240 x 175 mm (exl bracket)	
	150 x 240 x 206 mm (incl bracket)	
Packaging	Carton box (pair)	
Weight net (pair)	3.23 Kg	
Shipping weight / volume (pair)	4.48Kg / 0.03 Cbm	
Shipping weight masterpack (4pieces)	21.11 Kg / 0.12 Cbm	
Accessories included	Wall mounting bracket set	
	Mains power cable (1.5 meter)	
	Speaker cable (3.5 meter)	
Optional accessories	Mounting screws + plugs	
	AUDAC wall panel (check www.audac.eu for compatible products)	
	90° bracket	MBK455/B (black) MBK455/W (white)

