

USER MANUAL

_AUDIOFUSE

ARTURIA
_The sound explorers

Special Thanks

DIRECTION

Frederic Brun

Adrien Courdavault

Nicolas Dubois

ENGINEERING

Pierre Demouveau

Pierre Pfister

Jérôme Laurent

Mathieu Nocenti

Philippe Wicker

MANUAL

Adrien Courdavault

Germain Marzin

Vincent Le Hen

Jose Rendon

Jérémie Weber

Craig Anderton

Jimmy Michon

Gala Khalife

Morgan Perrier

Minoru Koike

Charlotte Métais

Holger Steinbrink

DESIGN

Frederic Brun

Daniel Vester

Glen Darcey

Fabien Deboves

Morgan Perrier

Sébastien Rochard

© ARTURIA SA - 2021 - All rights reserved.

26 avenue Jean Kuntzmann

38330 Montbonnot-Saint-Martin

FRANCE

www.arturia.com

Information contained in this manual is subject to change without notice and does not represent a commitment on the part of Arturia. The software described in this manual is provided under the terms of a license agreement or non-disclosure agreement. The software license agreement specifies the terms and conditions for its lawful use. No part of this manual may be reproduced or transmitted in any form or by any purpose other than purchaser's personal use, without the express written permission of ARTURIA S.A.

All other products, logos or company names quoted in this manual are trademarks or registered trademarks of their respective owners.

Product version: 1.2.3

Revision date: 9 April 2021

Thank you for purchasing the Arturia AudioFuse!

Dear musician,

AudioFuse is the revolutionary next-gen pro audio interface that sets a new standard in sonic quality, creative production and value. It fuses the superior sound of high-end analog studio consoles with the flexibility of a solid mobile interface—with all the connectivity you need for any recording or performance.



AudioFuse comes with very high quality audio pre-amplifier based on the DiscretePro technology.

AudioFuse connects you to a whole world of possibilities, gears and formats.

AudioFuse is a rock-solid foundation you can rely on to keep you in the creative flow in any situation.

Important Safety Instructions

PRECAUTIONS INCLUDE, BUT ARE NOT LIMITED TO, THE FOLLOWING:

1. Read and understand all the instructions.
2. Always follow the instructions on the device.
3. Before cleaning the device, always remove the USB and DC cable. When cleaning, use a soft and dry cloth. Do not use gasoline, alcohol, acetone, turpentine or any other organic solutions; do not use a liquid cleaner, spray or cloth that's too wet.
4. Do not use the device near water or moisture, such as a bathtub, sink, swimming pool or similar place.
5. Do not place the device in an unstable position where it might accidentally fall over.
6. Do not place heavy objects on the device. Do not block openings or vents of the device; these locations are used for air circulation to prevent the device from overheating. Do not place the device near a heat vent at any location with poor air circulation.
7. Do not open or insert anything into the device that may cause a fire or electrical shock.
8. Do not spill any kind of liquid onto the device.
9. Always take the device to a qualified service center. You will invalidate your warranty if you open and remove the cover, and improper assembly may cause electrical shock or other malfunctions.
10. Do not use the device with thunder and lightning present; it may cause electrical shock.
11. Do not expose the device to hot sunlight.
12. Do not use the device when there is a gas leak nearby.
13. Be sure to turn off or disconnect your speakers and phones from the interface, before updating the firmware of the unit.

14. Arturia recommends to reset the unit to the factory default settings after a firmware update, by simultaneously holding the Speaker Cue and Mono buttons when powering up the unit.
15. Arturia is not responsible for any damage or data loss caused by improper operation of the device.

Specifications subject to change:

The information contained in this manual is believed to be correct at the time of printing. However, Arturia reserves the right to change or modify any of the specifications without notice or obligation to update the hardware that has been purchased.

IMPORTANT :

The product and its software, when used in combination with an amplifier, headphones or speakers, may be able to produce sound levels that could cause permanent hearing loss. DO NOT operate for long periods of time at a high level or at a level that is uncomfortable. If you encounter any hearing loss or ringing in the ears, you should consult an audiologist.

NOTICE :

Service charges incurred due to a lack of knowledge relating to how a function or feature works (when the product is operating as designed) are not covered by the manufacturer's warranty, and are therefore the owner's responsibility. Please study this manual carefully and consult your dealer before requesting service.

Table Of Contents

1. Overview	2
2. Hardware Features	4
2.1. Specifications	4
2.2. Getting to know your AudioFuse	7
3. Getting started	12
3.1. Powering your AudioFuse	12
3.2. Setting your Operating System	13
3.3. Inputs and Outputs	16
3.4. AudioFuse Mixer and Routing	26
3.5. USB Audio mapping	28
3.6. Clock Synchronisation	29
3.7. Re-Amping	31
3.8. Talkback	32
3.9. MIDI Interface	32
3.10. The AudioFuse Control Center	33
3.11. The AudioFuse switch	34
3.12. Reset to factory settings	35
4. How to use the AudioFuse	36
4.1. Using an external effect on inputs 1 and 2 with inserts	36
4.2. How to record a microphone	37
4.3. How to record a guitar or an instrument	38
4.4. Use one phone for Cue, and one for Main	39
4.5. Use AudioFuse to switch between 2 sets of speakers	40
4.6. Use the AudioFuse without a computer	41
5. Software License Agreement	42
6. Declaration of Conformity	46

1. OVERVIEW

Box Content

- AudioFuse
- Power Supply + worldwide adaptors
- Double USB cable
- 2x MIDI Adaptors
- User Manual
- Registration card with Serial and Unlock Code
- DiscretePro® certificate

DiscretePRO® certificate

Your AudioFuse comes with 2 pre-amplifiers using the DiscretePRO® technology to ensure the best audio quality when recording. Your AudioFuse is unique and therefore it comes with its own Audio Precision certificate as a guarantee of its performance.

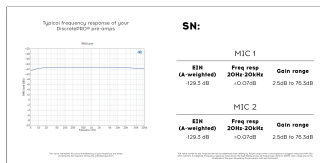

A version with more details is available after registration on www.arturia.com/register

Register your AudioFuse

Registering your AudioFuse provides the following benefits:

- Free software license for the AudioFuse Creative Suite, an ever-evolving collection of software effects and instruments that will let you add your own unique signature to your music
- Access to the latest version of the AudioFuse Control Center software
- Special offers restricted to AudioFuse owners

To get access to the AudioFuse Software and support register your product on www.arturia.com/register with your registration card.



Important: Go to www.arturia.com/audiofuse-start to register your product, check for the latest firmware, download the user guide and the AudioFuse Control Center software (AFCC).

You will need the plastic registration card with Serial Number and Unlock Code for your product.



2. HARDWARE FEATURES

2.1. Specifications

- 14 Input, 14 Output channels
- 4 analog inputs 2x Mic/Instrument/Line
- 2x Phono/Line
- 4 analog outputs
- 2 analog inserts
- ADAT In & Out
- SPDIF In & Out
- Word Clock In & Out
- MIDI In & Out
- 3-port USB hub
- 2 microphone preamps
- 24-bit latest generation AD/DA converters at up to 192kHz sampling rate.
- 2 phono RIAA preamps
- Talkback feature with a dedicated built-in microphone
- A/B speaker switching
- Direct monitoring
- Separate Master & Monitor mix channels
- USB interface with PC, Mac, iOS, Android compatibility
- Aluminum chassis, leather-covered top

Line/Instrument inputs	
Line Input Impedance	20k ohms symetric, 10k ohms asymeric
Instrument Input Impedance	1.1M ohms asymeric
Frequency Response 20Hz/20kHz	< +/- 0.08dB
Instrument Max Input Level	+18dBu
Max Input Level	+24dBu

Microphone Preamps	
Input Impedance	4k ohms
Equivalent Input Noise (EIN) @ 72dB gain	<-129.3dBu (A-weighted)
Frequency Response 20Hz/20kHz	< +/- 0.08dB
Gain Range	3dB to 72dB

Inserts	
Output Impedance	<35 ohms
Input Impedance	10k ohms asymeric
Max Output Level	+18dBu
Nominal Input Level	+18dBu

Line Input to Digital	
THD+N	-101dB (A-weighted)
Dynamic Range	106dB (A-weighted)

Line Output	
Output Impedance	<120 ohms
Max Output Level	+24dBu
Dynamic Range	119dB (A-weighted)
THD+N	-104dB (A-weighted)

Clocks	
Supported Frequency Rates	44.1 kHz, 48 kHz, 88.2 kHz, 96 kHz, 176.4 kHz, 192 kHz

2.2. Getting to know your AudioFuse

2.2.1. Back View

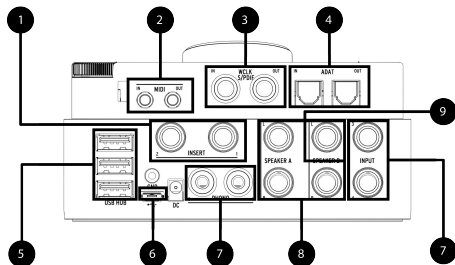

1. Inserts: Add external line level devices such as compressors into the signal flow before the digital conversion.

2. MIDI In/Out: Connect any MIDI instrument or equipment.

3. WordClock & S/PDIF In/Out: Sync to any Word Clock equipment or connect to any S/PDIF digital audio device.

4. ADAT In/Out: Connect to any ADAT equipment with up to 8 digital inputs and 8 digital outputs.

5. USB hub: 3-port USB hub to connect your master keyboard, USB stick or dongle.

6. USB connection: Connect Audiofuse to your computer with the provided USB double cable **only**. Most features will be available even when only the USB power supplied by a computer. Power supply and specific adapters will be required to connect Audiofuse to tablets and phones.

7. Phono/Line inputs 3&4: Connect external phono or line devices to these RCA+ground and balanced 1/4" inputs.

8. Speaker outputs A&B: Connect two pairs of speakers to these balanced 1/4" outputs for easy A/B monitoring.

9. Re-Amping Output: This output can change impedance and allow you to send a recorded dry guitar or bass track back out to any amp for rerecording later.

2.2.2. Top View

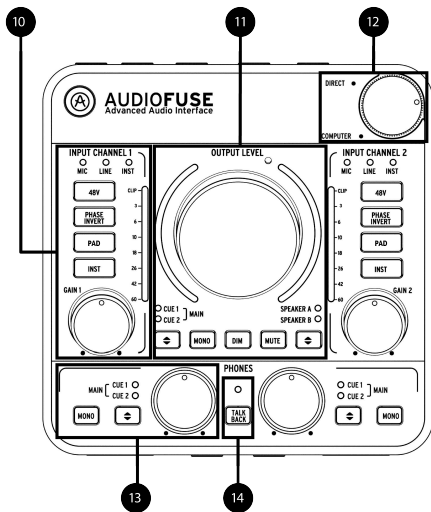

10. Input control sections 1&2: Direct access to each feature of analog inputs 1&2: input gain with vu-metering, true 48V, phase invert, -20dB pad, "boost" option for MIC signals and instrument mode.

11. Output control section: Direct access to each of the analog output features: output level with vu-metering, audio mix selection, mono mode, output dimming, mute, and Speaker A/B selection.

12. Direct monitoring: Enjoy zero latency monitoring of the recorded signals and blend them into your mix.

13. Phones control sections 1&2: Direct access to each of the features of Phones 1&2 outputs: output level, mono mode and audio mix selection.

14. Talkback: Press a button to give directions to your talent who is in a booth or another room: use the talkback feature with the built-in microphone.



Talkback only works on sample rates up to 96kHz.

2.2.3. Front View

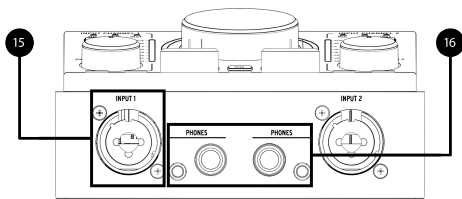

15. Input channels 1&2: Connect microphones, instruments or line devices to the 2 XLR/ balanced 1/4" combo inputs.

16. Phones output channels 1&2: Don't bother looking for a 1/4" or 1/8" phones adapter; AudioFuse has both connectors for each phones output.

3. GETTING STARTED

3.1. Powering your AudioFuse

Apply power to AudioFuse by connecting the provided power supply (18V, 1.66A) to the AudioFuse's DC power connector, or bus-power AudioFuse directly from computers whose USB ports can provide sufficient power.

The AudioFuse Control Center can select between two power modes: Standard or Full Power.

Standard mode is the factory default. Full Power mode requires connecting the external power supply to the interface. Full Power allows broadcast-grade, +24dBu max output levels, and provides up to 1 Amp on the AudioFuse's USB hub ports.

The table below summarizes these different modes, and how they relate to the external power supply.

standard mode	standard mode	Full Power Mode
Bus powered (no external power supply)	With the external power supply	Requires the external power supply
+18dBu max input levels	+18dBu max input levels	+24dBu max input levels
+18dBu max output levels	+18dBu max output levels	+24dBu max output levels
USB hub: Up to 100mA shared among all ports	USB hub : 1A on each USB port	USB hub : 1A on each USB port

Given power limitations on some computers' USB ports, we also recommend using the external power supply when +48V is active on both input channels.

3.2. Setting your Operating System

3.2.1. Set up on Macintosh

Connect your AudioFuse to the USB Port, your AudioFuse simply show up in *Audio MIDI Setup* immediately.

To set it up as your default device:

- Select it in the Audio MIDI Settings left panel,
- Then select set as default output/input device.

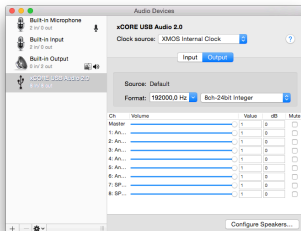
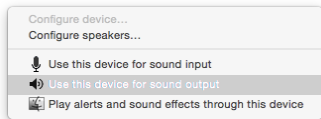

3.2.2. Set up on Windows

Low latency drivers on Windows are provided by Arturia and are automatically installed with the AudioFuse Control Center installer.

You can get it on www.arturia.com/audiofuse-start

Once this is installed, simply connect AudioFuse to the USB ports, using the provided double-USB cable, it will automatically appear in your audio devices.

Open "Manage Audio Device".

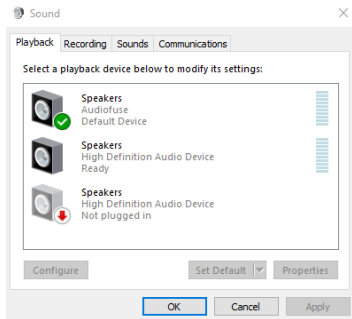
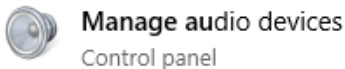

To set it up as your default playback (recording) device, in the playback (recording) tab select AudioFuse and click on *Set Default*.

3.2.3. Set up on iPad/iPhone

Connect AudioFuse to the DC adaptor (required) and to the iPad/iPhone through a camera connection kit. The device will appear in Settings > General > About > AudioFuse. For more info on the compatibility look on www.arturia.com/audiofuse-start

3.2.4. Set up on Android

Connect AudioFuse to the DC adaptor (required) and to the Android device through an On-The-Go cable (USB A female - USB B micro). Android 5+ is required. For more info on the compatibility look on www.arturia.com/audiofuse-start

3.3. Inputs and Outputs

3.3.1. Inputs 1 & 2

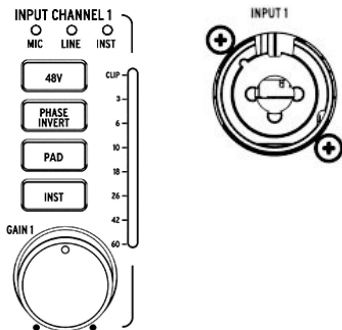

AudioFuse offers two real parallel preamplifiers for microphone and line/instrument inputs.

The input Channels 1 and 2 offer full control of mic preamp on the interface with

- **48V** : Phantom power activation
- **Phase invert** : Reverse signal polarity to use when recording with multiple microphones
- **PAD** : -20dB pad function for headroom. When a source is connected to the preamp, a short press on PAD will apply a -20dB pad to your signal. If the input signal type is MIC, a long press on PAD will add a "boost" to your mic signal.



! The PAD boost function allows the preamp to reach extremely high gain values suppressing the need for any signal booster in the chain, even with low level mics such as Sure® SM7B. This integrated function is fairly unique in an audio interface and at the core of Arturia's original DiscretePro® preamp.

- **INST** : to switch from LINE to INST level and impedance.
- **GAIN** : +2 to +70dB DiscretePro® Preamplifier analog gain control knob.
- **-60dB to clip led meter with peak hold.**

The XLR/TRS Jack combi-connectors will auto-detect which connector is used.

If you use an XLR connector, the input type MIC is auto-selected. Otherwise the LINE/INST input is available and you can switch between those with the INST button.



Note on Phantom Power: The phantom power is rated 14 mA per channel.

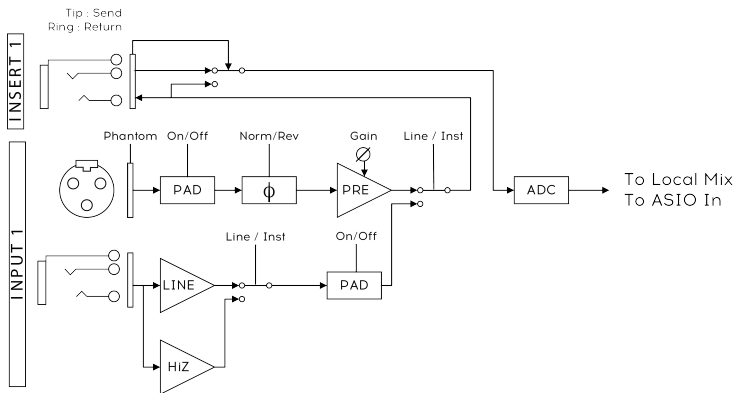

Input channel 1&2 path

3.3.2. Inserts 1 & 2

On the back of the AudioFuse you can find an insert section featuring 2 TRS Jack (tip=send, ring=receive). These can be used to insert your favourite processing unit before the converters and directly after the DiscretePRO® pre-amplifiers of inputs 1 & 2. When not used, these connectors do not need to be patched.

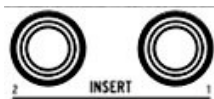

Insert are working at line level (+18 dBu for 0 dBFS)

i **Tip** : You could also send line level input signal directly to the converters (and bypass the pre-amplifier) only by PARTIALLY plugging mono Jack cables into insert plugs, while any XLR or Jack cable is plugged into MIC INPUTS 1 or 2.

3.3.3. Inputs 3 & 4

AudioFuse also provides two additional line inputs and two phono inputs labelled 3 & 4. By default the line input 3 & 4 are selected.

A 20db pad can be activated in AudioFuse Control Center. When using Line input, you can switch input 3 to 'INST' mode in Audiofuse Control Center. Phono inputs can be activated from the AudioFuse Control Center.

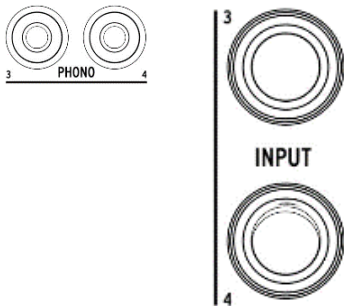

You cannot use the Line and Phono inputs simultaneously.

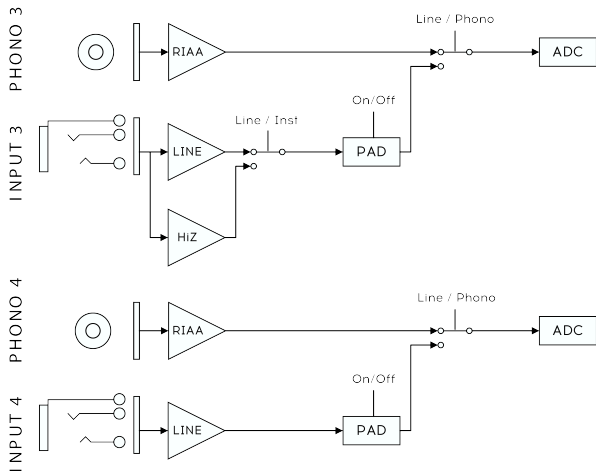

Input channel 3&4 path

3.3.4. Digital inputs

AudioFuse provides up to 8 digital inputs on S/PDIF or ADAT.

You can switch between ADAT and S/PDIF using the AudioFuse Control Center.

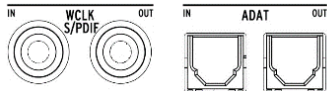

3.3.5. Main Output

AudioFuse offers 4 stereo outputs : Phones 1 / Phones 2 / Speaker A / Speaker B

On each of these you can listen to Main, Cue 1 or Cue 2 buses, by using the selectors available on the interface.

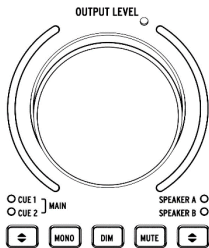

The *Output Level* section also features various settings:

- **CUE** : selector to switch between output buses to listen.
- **MONO** : Mix stereo pair down to mono. Useful when you need to check your mix in mono
- **DIM** : reduce the output level. The amount of level reduction is available in AudioFuse Control Center.
- **Mute**
- **Speaker A/B** selector to switch between 2 sets of speakers.
- **OUTPUT LEVEL** : output level knob

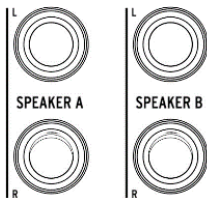

A special feature allow to send phone 2 in the speaker B output. (Refer to phone outputs below). This function inhibit Speaker A/B function.

3.3.6. Phone Outputs

Phone output is similar to main output. You can select your source and mix down to mono.

Phone 2 output has a secondary function. You can send it to speaker B outputs. By activating the Phone 2 to Speaker B function in the AudioFuse control Center, you send the phone 2 signal to speaker B output.

In this case, speaker A is automatically selected for speaker Output.

You can then use the Re-Amping Function on speaker B Left output. (Refer to Re-Amping below)

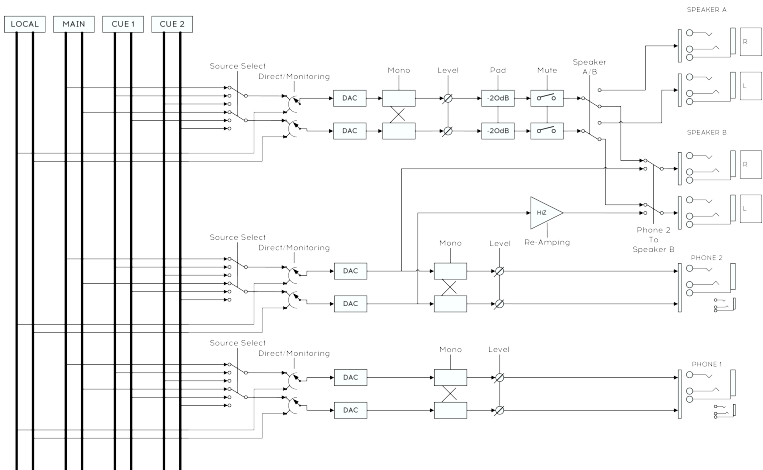

3.4. AudioFuse Mixer and Routing

AudioFuse offers 3 output buses: main, Cue 1 and Cue 2 plus one internal mixer. These three output buses are available in your audio driver. Each output is sourced from any of these buses with a selector on the device, by pressing the button to switch between them.

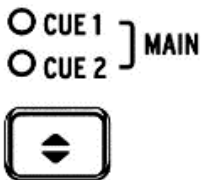

To add direct monitoring to the selected bus, activate local monitoring on the output in the AudioFuse Control Center and turn the *Direct/Computer* mix knob to adjust the quantity of Direct versus Computer output.

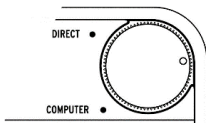

The local monitoring bus mix is set in AudioFuse Control Center. You can add each physical input to the bus, adjust level and pan, select mute or solo or even link it by pairs.

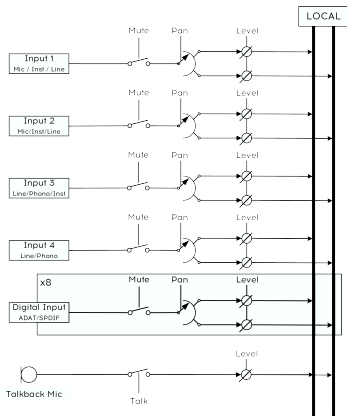

3.5. USB Audio mapping

In your computer, you will find up to 14 in and 14 outputs

Input	Computer	Computer	Output
Input 1: MIC / LINE / INST	IN 1	OUT 1	MAIN L
Input 2: MIC / LINE / INST	IN 2	OUT 2	MAIN R
Input 3: LINE / PHONO / INST	IN 3	OUT 3	CUE 1 L
Input 4: LINE / PHONO	IN 4	OUT 4	CUE 1 R
Talkback MIC	IN 5	OUT 5	CUE 2 L
Talkback MIC	IN 6	OUT 6	CUE 2 R
ADAT 1 / SPDIF L	IN 7	OUT 7	ADAT 1 / SPDIF L
ADAT 2 / SPDIF R	IN 8	OUT 8	ADAT 2 / SPDIF R
ADAT 3	IN 9	OUT 9	ADAT 3
ADAT 4	IN 10	OUT 10	ADAT 4
ADAT 5	IN 11	OUT 11	ADAT 5
ADAT 6	IN 12	OUT 12	ADAT 6
ADAT 7	IN 13	OUT 13	ADAT 7
ADAT 8	IN 14	OUT 14	ADAT 8

3.6. Clock Synchronisation

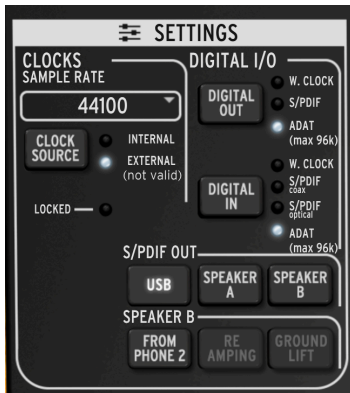

The Audiofuse can run on its own internal clock or it can sync to external sources.

The internal clock in Audiofuse is extremely stable and will offer you the best performance in most situations. If you have the option to drive your peripheral gear from the Audiofuse clock, please do so.

To change sync sources open the Audiofuse Control Center software.

In the upper left side, under the SETTINGS header, you can see options for CLOCK SOURCE: INTERNAL or EXTERNAL. When set to EXTERNAL, your input sync options are:

- Word Clock - using the RCA inputs on the rear panel
- S/PDIF Coax - using the RCA inputs on the rear panel
- S/PDIF optical - using the ADAT IN optical connector
- ADAT - using the ADAT IN optical connector



96kHz is the maximum samples rate clock for ADAT.



The internal clock of the AudioFuse can be set to 44.1 kHz, 48 kHz, 88.2 kHz, 96 kHz, 176.4 and 192 kHz from your DAW, your audio device settings, or in the AudioFuse Control Center.

When using Word Clock input, you might need to terminate the input. Open the PREFERENCES in the Audiofuse Control Center and select either NONE or 75 OHM as your option for the input.

To use Audiofuse as a master clock for other devices, set clock source as INTERNAL and use the settings in the DIGITAL OUT section to choose the type you want to send.

Your clock out options are:

- Word Clock
- S/PDIF
- ADAT

When external clock is chosen as master clock, internal clock must be set as the same or "multiple or divided" rate sample rate.

3.7. Re-Amping

AudioFuse has a great Re-Amping function. Re-Amping is also called reverse D-I and is used to play a direct guitar track in an amplifier. You can now re-record the amplified sound.

For this, you need a track with a direct guitar sound.

You activate the Re-Amping function in the AudioFuse Control Center, by pressing "FROM PHONE 2" switch and then "REAMPING" switch. You can also press "GROUND LIFT" switch if needed. See Audiofuse Control Center online manual for more details.

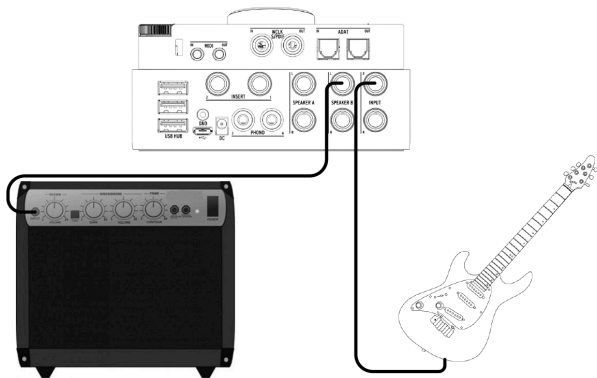

3.8. Talkback

The talkback is a simple mic built in the AudioFuse you can activate by pressing the *talkback* button.



Talkback only works on sample rates up to 96kHz.

Your voice will be transmitted on input 5&6 in your computer and can be mixed into the physical outputs Speaker, Phone 1 and Phone 2.

The level of the talkback and the selected outputs can be set in the AudioFuse Control Center.

3.9. MIDI Interface

MIDI In and MIDI Out ports are available at back of the AudioFuse. The Jack to DIN adapter is included in your package.

The MIDI ports are available in your computer once the AudioFuse drivers are installed.

3.10. The AudioFuse Control Center

The AudioFuse Control Center can be downloaded on www.arturia.com/audiofuse-start

This application will let you manage all the special functions that are not directly accessible on the AudioFuse device.



These include:

- Input 3 & 4 selection
- Change the Digital input setting
- Clock & Synchronization settings
- Update the firmware version
- Change the Monitor Mix

The software is compatible with Windows 7+ and Mac OSX 10.8+.

In order to use the software, you must connect the AudioFuse.

3.11. The AudioFuse switch

Pressing the Arturia switch will automatically wake up the AudioFuse Control Center on your computer.



3.12. Reset to factory settings

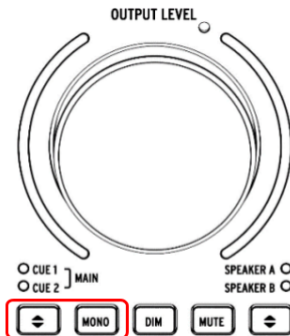

Resetting the unit to factory settings is possible by holding the Speaker Cue selector + Mono button while booting the unit (connecting the USB port or the Power Supply connector). This operation is recommended after a firmware upgrade.

4. HOW TO USE THE AUDIOFUSE

4.1. Using an external effect on inputs 1 and 2 with inserts

Record your mic and process it using an external processing unit before recording.

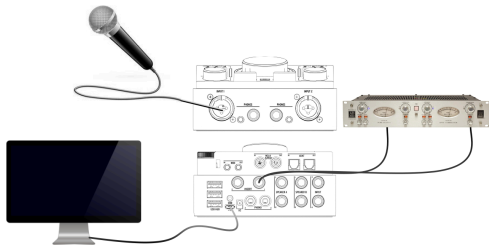

4.2. How to record a microphone

If you need to record microphones, simply use the inputs 1 or 2 on the front.

1. Connect your microphone with a XLR.
2. The AudioFuse will auto-detect that you are using a microphone input.
3. Set your phantom power (if needed) and your gain.

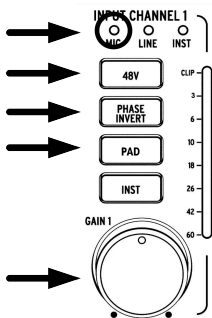

4.3. How to record a guitar or an instrument

If you need to record instruments like guitars and synths, simply use the inputs 1 or 2 on the front.

1. Connect your instrument with a TRS jack or a standard tip/sleeve jack.
2. The AudioFuse will auto-detect you are using either a line or instrument input, press the "Inst" button of the input section to light the "Inst" input mode.

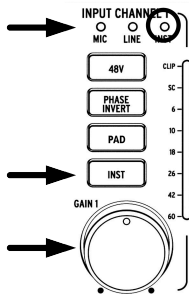

You can use Input 3 in the same way by setting it in the AudioFuse Control Center.

4.4. Use one phone for Cue, and one for Main

You can use 2 different sets of headphones and use each one to listen to a different mix.

Use the Main/Cue bus selector above the Headphone plug to set which mix you want to listen to;

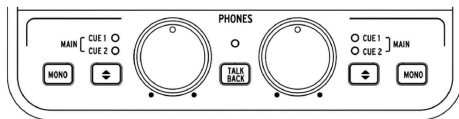

4.5. Use AudioFuse to switch between 2 sets of speakers

With the Speaker A/Speaker B function on the AudioFuse, you can easily switch the master output between 2 different sets of speakers. This will allow for quick monitor referencing to check your mix.

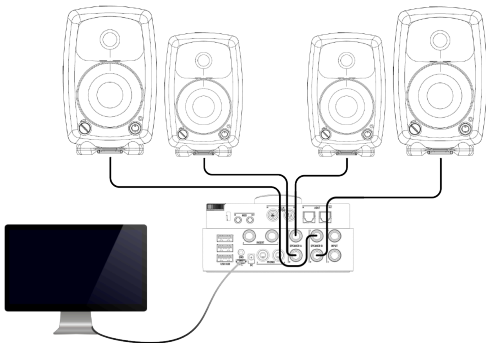

4.6. Use the AudioFuse without a computer

The AudioFuse can work standalone (without a computer), as a mixing unit.

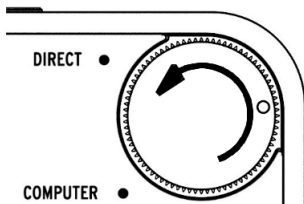

To do this:

1. Connect your inputs on the analog inputs 1 to 4 and Digital inputs like ADAT.
2. Connect your outputs.
3. Connect the AudioFuse to the computer
4. In the AudioFuse Control Center set the mix you want for your output.
5. Set the Direct Monitor knob on the right of the AudioFuse to "Direct".

Now you can unplug the computer, this mix setup will work without it.

The settings are saved in AudioFuse Unit for next time!

Technical information

More information can be found at www.arturia.com/audiofuse-start

5. SOFTWARE LICENSE AGREEMENT

In consideration of payment of the Licensee fee, which is a portion of the price you paid, Arturia, as Licensor, grants to you (hereinafter termed "Licensee") a nonexclusive right to use this copy of the SOFTWARE.

All intellectual property rights in the software belong to Arturia SA (hereinafter: "Arturia"). Arturia permits you only to copy, download, install and use the software in accordance with the terms and conditions of this Agreement.

The product contains product activation for protection against unlawful copying. The OEM software can be used only following registration.

Internet access is required for the activation process. The terms and conditions for use of the software by you, the end-user, appear below. By installing the software on your computer you agree to these terms and conditions. Please read the following text carefully in its entirety. If you do not approve these terms and conditions, you must not install this software. In this event give the product back to where you have purchased it (including all written material, the complete undamaged packing as well as the enclosed hardware) immediately but at the latest within 30 days in return for a refund of the purchase price.

1. Software Ownership Arturia shall retain full and complete title to the SOFTWARE recorded on the enclosed disks and all subsequent copies of the SOFTWARE, regardless of the media or form on or in which the original disks or copies may exist. The License is not a sale of the original SOFTWARE.

2. Grant of License Arturia grants you a non-exclusive license for the use of the software according to the terms and conditions of this Agreement. You may not lease, loan or sublicense the software.

The use of the software within a network is illegal where there is the possibility of a contemporaneous multiple use of the program.

You are entitled to prepare a backup copy of the software which will not be used for purposes other than storage purposes.

You shall have no further right or interest to use the software other than the limited rights as specified in this Agreement. Arturia reserves all rights not expressly granted.

3. Activation of the Software Arturia may use a compulsory activation of the software and a compulsory registration of the OEM software for license control to protect the software against unlawful copying. If you do not accept the terms and conditions of this Agreement, the software will not work.

In such a case the product including the software may only be returned within 30 days following acquisition of the product. Upon return a claim according to § 11 shall not apply.

4. Support, Upgrades and Updates after Product Registration You can only receive support, upgrades and updates following the personal product registration. Support is provided only for the current version and for the previous version during one year after publication of the new version. Arturia can modify and partly or completely adjust the nature of the support (hotline, forum on the website etc.), upgrades and updates at any time.

The product registration is possible during the activation process or at any time later through the Internet. In such a process you are asked to agree to the storage and use of your personal data (name, address, contact, email-address, and license data) for the purposes specified above. Arturia may also forward these data to engaged third parties, in particular distributors, for support purposes and for the verification of the upgrade or update right.

5. No Unbundling The software usually contains a variety of different files which in its configuration ensure the complete functionality of the software. The software may be used as one product only. It is not required that you use or install all components of the software. You must not arrange components of the software in a new way and develop a modified version of the software or a new product as a result. The configuration of the software may not be modified for the purpose of distribution, assignment or resale.

6. Assignment of Rights You may assign all your rights to use the software to another person subject to the conditions that (a) you assign to this other person (i) this Agreement and (ii) the software or hardware provided with the software, packed or preinstalled thereon, including all copies, upgrades, updates, backup copies and previous versions, which granted a right to an update or upgrade on this software, (b) you do not retain upgrades, updates, backup copies and previous versions of this software and (c) the recipient accepts the terms and conditions of this Agreement as well as other regulations pursuant to which you acquired a valid software license.

A return of the product due to a failure to accept the terms and conditions of this Agreement, e.g. the product activation, shall not be possible following the assignment of rights.

7. Upgrades and Updates You must have a valid license for the previous or more inferior version of the software in order to be allowed to use an upgrade or update for the software. Upon transferring this previous or more inferior version of the software to third parties the right to use the upgrade or update of the software shall expire.

The acquisition of an upgrade or update does not in itself confer any right to use the software.

The right of support for the previous or inferior version of the software expires upon the installation of an upgrade or update.

8. Limited Warranty Arturia warrants that the disks on which the software is furnished is free from defects in materials and workmanship under normal use for a period of thirty (30) days from the date of purchase. Your receipt shall be evidence of the date of purchase. Any implied warranties on the software are limited to thirty (30) days from the date of purchase. Some states do not allow limitations on duration of an implied warranty, so the above limitation may not apply to you. All programs and accompanying materials are provided "as is" without warranty of any kind. The complete risk as to the quality and performance of the programs is with you. Should the program prove defective, you assume the entire cost of all necessary servicing, repair or correction.

9. Remedies Arturia's entire liability and your exclusive remedy shall be at Arturia's option either (a) return of the purchase price or (b) replacement of the disk that does not meet the Limited Warranty and which is returned to Arturia with a copy of your receipt. This limited Warranty is void if failure of the software has resulted from accident, abuse, modification, or misapplication. Any replacement software will be warranted for the remainder of the original warranty period or thirty (30) days, whichever is longer.

10. No other Warranties The above warranties are in lieu of all other warranties, expressed or implied, including but not limited to, the implied warranties of merchantability and fitness for a particular purpose. No oral or written information or advice given by Arturia, its dealers, distributors, agents or employees shall create a warranty or in any way increase the scope of this limited warranty.

11. No Liability for Consequential Damages Neither Arturia nor anyone else involved in the creation, production, or delivery of this product shall be liable for any direct, indirect, consequential, or incidental damages arising out of the use of, or inability to use this product (including without limitation, damages for loss of business profits, business interruption, loss of business information and the like) even if Arturia was previously advised of the possibility of such damages. Some states do not allow limitations on the length of an implied warranty or the exclusion or limitation of incidental or Oconsequential damages, so the above limitation or exclusions may not apply to you. This warranty gives you specific legal rights, and you may also have other rights which vary from state to state.

6. DECLARATION OF CONFORMITY

USA

Important notice: DO NOT MODIFY THE UNIT!

This product, when installed as indicate in the instructions contained in this manual, meets FCC requirement. Modifications not expressly approved by Arturia may avoid your authority, granted by the FCC, to use the product.

IMPORTANT: When connecting this product to accessories and/or another product, use only high quality shielded cables. Cable (s) supplied with this product **MUST** be used. Follow all installation instructions. Failure to follow instructions could void your FFC authorization to use this product in the USA.

NOTE: This product has been tested and found to comply with the limit for a Class B Digital device, pursuant to Part 15 of the FCC rules. These limits are designed to provide a reasonable protection against harmful interference in a residential environment. This equipment generate, use and radiate radio frequency energy and, if not installed and used according to the instructions found in the users manual, may cause interferences harmful to the operation to other electronic devices. Compliance with FCC regulations does not guarantee that interferences will not occur in all the installations. If this product is found to be the source of interferences, witch can be determined by turning the unit "OFF" and "ON", please try to eliminate the problem by using one of the following measures:

- Relocate either this product or the device that is affected by the interference.
- Use power outlets that are on different branch (circuit breaker or fuse) circuits or install AC line filter(s).
- In the case of radio or TV interferences, relocate/ reorient the antenna. If the antenna lead-in is 300 ohm ribbon lead, change the lead-in to coaxial cable.
- If these corrective measures do not bring any satisfied results, please the local retailer authorized to distribute this type of product. If you cannot locate the appropriate retailer, please contact Arturia.

The above statements apply **ONLY** to those products distributed in the USA.

CANADA

NOTICE: This class B digital apparatus meets all the requirements of the Canadian Interference-Causing Equipment Regulation.

AVIS: Cet appareil numérique de la classe B respecte toutes les exigences du Règlement sur le matériel brouilleur du Canada.

EUROPE



This product complies with the requirements of European Directive 89/336/EEC

This product may not work correctly by the influence of electro-static discharge; if it happens, simply restart the product.