

USBMIX4

FOUR CHANNEL MIXER WITH USB INTERFACE

Project Series



User's Manual



IMPORTANT SAFETY INSTRUCTIONS - READ FIRST



This symbol, wherever it appears, alerts you to the presence of uninsulated dangerous voltages inside the enclosure that may be sufficient to constitute a risk of shock.



This symbol, wherever it appears, alerts you to important operating and maintenance instructions in the accompanying literature. Please read the manual.

Read instructions

Retain these safety and operating instructions for future reference. Heed all warnings printed here and on the equipment. Follow the operating instructions printed in this user guide.

Do not open

There are no user serviceable parts inside. Refer any service work to qualified technical personnel only.

Power sources

Only connect the unit to mains power of the type described in this user guide or marked on the rear panel. The power source must provide a good ground connection.

Power supply

Use the external power supply for your local mains supply as provided with the equipment. If the provided external supply does not fit into your outlet consult your service agent. Route the external power cord so that it is not likely to be walked on, stretched or pinched by items placed upon or against.

Grounding

Do not defeat the grounding and polarization means of the external power supply.

Moisture

To reduce the risk of fire or electrical shock, do not expose the unit to rain, moisture or use in damp or wet conditions. Do not place container of liquid on it, which may spill into any openings

Heat

Do not locate the unit in a place close to excessive heat or direct sunlight, as this could be a fire hazard. Locate the unit away from any equipment, which produces heat such as: power supplies, power amplifiers and heaters.

Environment

Protect from excessive dirt, dust, heat, and vibration when operating and storing. Avoid tobacco ash, drink spillage and smoke especially that associated with smoke machines.

Handling

Protect the controls from damage during transit. Use adequate padding if you need to ship the unit. To avoid injury to yourself or damage to the equipment take care when lifting, moving or carrying the unit.

Servicing

Switch off the equipment and unplug the power cord immediately if it is exposed to moisture, spilled liquid or the power cord or plug becomes damaged during a lightning storm or if smoke odor or noise is noted. Refer servicing to qualified technical personnel only.

Installation

Install the unit in accordance with the instruction printed in the user manual.

INTRODUCTION

The ART **USBMIX4** Microphone, Instrument, and Line Mixer/Computer Interface is a compact versatile audio interface for your computer that converts analog signals from a variety of audio sources to a digital signal that your computer recognizes. It can also be used as a stand-alone mixer through the main mix outputs. The **USBMIX4** provides a great starting point for personal home studio recording or for anyone wants to do mobile location recording. Use the **USBMIX4** to record pod casts, capture your latest idea for a song, make voiceovers for your home movies, or record a jam with a friend - whenever and wherever your creativity takes you!

Features

- Powered by USB from your computer or via USB power adapter (included)
- CH1 and 2 Microphone (balanced XLR) inputs or instrument (unbalanced ¼-inch TS) inputs with switchable impedances
- Switchable low noise +48V phantom power for microphones
- Balanced ¼-inch TRS inputs for stereo or mono line-level sources on CH3
- ¼-inch TRS output jacks work with balanced or unbalanced lines
- ⅛-inch TRS stereo Aux/MP3 input
- Stereo output, independent from the PC interface switch
- Stereo ¼-inch TRS headphone jack with independent level control for output monitoring
- Independent controls for both sets of inputs, main output, and headphone monitor
- Red LED signal/clip indicator for Ch1-2
- No special drivers are needed with most modern versions of Windows or Mac OS and Linux
- USB cable, USB power adaptor and Audacity recording software included
- Rugged steel chassis

INSTALLATION

Prior to power up or power down, the output controls PHONES MONITOR and MAIN MIX should be turned back to "0".

1. As audio sources, microphones and/or audio sources with line signal level (e.g. effect units, musical instruments, players) can be connected to the four input channels.
2. Mono channels CH1 and CH2:
3. Combined XLR/¼-inch jack are available as inputs
4. Connect microphones to the balanced XLR jack.
5. For phantom-powered microphones, you must engage the 48V phantom power switch for channel CH-1 XLR jack. When the switch is engaged, (switch position  =on) the Phantom power -LED is illuminated to indicate that Phantom power is being used.

Caution! Do not connect a microphone with unbalanced output via XLR plug; it may be damaged by the phantom power function. To prevent switching noise, only activate or deactivate the phantom power when the mixer is switched off or the output controls are set to "0".

6. Connect mono sources with the line level to the unbalanced 1/4-inch jacks. It is also possible to directly -connect musical instruments of high impedances (electric guitar, electric bass) to Stereo channels CH3/4.
7. Stereo sources with a line level may be connected to the ¼-inch jack of channel CH3/4, (L=left channel, R= right channel). The jacks of channel CH3/4 are balanced, however, it is also possible to connect units with unbalanced output via two-pole plugs. For connecting a mono unit to channel CH3/4, use Left jack only: Then the mono signal is internally sent to the left channel and the right channel.
8. Connect stereo headphones (impedance ≥ 8 OHM) to the ¼-inch jack PHONES MONITOR or the ⅛-inch jack HEADSET headphone  output jack.
9. The sum signal adjusted with the control MAIN MIX is present at the stereo output MAIN MIX OUT.
10. Here example, an amplifier or a second mixer may be connected. The ¼-inch jacks are unbalanced.
11. To switch on the mixer, set the POWER switch to position **ON**. The power indication POWER lights up.

CONTROLS AND INDICATORS

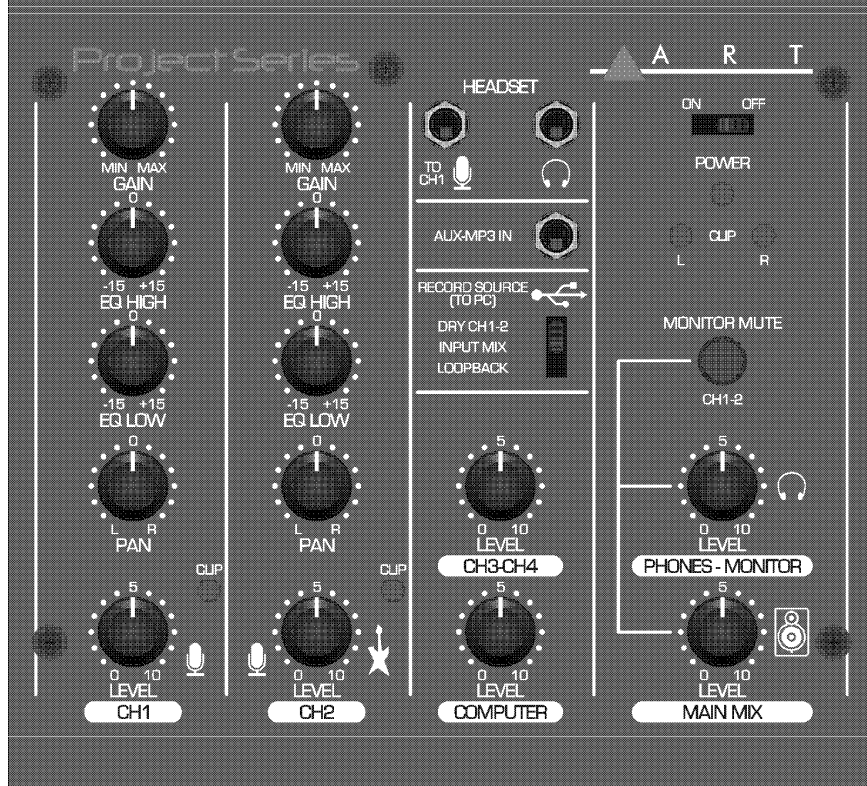
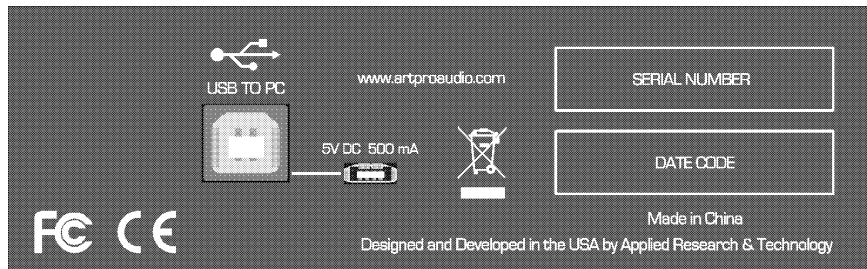

USB jack (type B): For connecting to a computer using the included USB 2.0 cable. When connected to a computer, the computer supplies power to the mixer and audio data can be sent between the mixer and computer.

Note: *Please do not connect any device to this USB jack other than a personal computer or tablet devices.*

5V DC IN jack (type micro B): For connecting to a USB power adapter or USB mobile battery.

Note:

1. Please read the safety precautions for the USB power adapter or USB mobile battery you are using.
2. Use a USB power adapter or USB mobile battery that can supply power via a USB micro B plug based the following USB standards:

Output voltage: 4.5 V to 5.2V

Output current: 500mA or greater

Combo input (combined jack XLR, balanced / ¼-inch jack) for channel CH 1, for the connection of a microphone via an XLR plug or an audio source with line signal level via a 1/4-inch plug.

Mono input (combined jack XLR, balanced / ¼-inch jack unbalanced) for channel CH 2 for the connection of a microphone via an XLR plug or an audio source with line signal level via a Phone plug.

+48V phantom switch [+48V] Led: When this switch is turn on(☑), the [+48V] lights and DC +48V phantom power is supplied to the XLR plug connected to the channel 1, Turn this switch on when using a phantom-powered condenser microphone.

Note: Be sure to leave this switch off if you do not need phantom power. Follow the important precautions below, in order to prevent noise and possible damage to external devices as well as the mixer if you turn this switch on (☑)

1. Be sure to leave this switch off(☒) when you connect a device that does not support phantom power to channel 1.
2. Make sure to turn this switch off(☒) when connecting / disconnecting a cable to / from channel
3. Turn the level knob of the channel 1 to “0” (minimum) before turning this switch on(☑) / off(☒)

PAD switches: Turning the switch on (☑) will attenuate the sound input to the unit. If you hear distortion or the [CLIP] Led lights frequently even if the [GAIN] pot is turned fully to the left, turn this switch on.

Note: Turn the level pot to minimum before toggling the [PAD] switch on(☑) and off(☒). Otherwise, noise may be produced.

Impedance switch For channel CH 2: press the button when an electric guitar or an electric bass with passive audio pick-up has been connected to the jack ¼-inch.

Stereo input (¼-inch jack, balanced) for channel CH 3 - Ch 4 for connection of an audio source with line signal level; when connection a mono source, use the left jack only.

Gain switch Determines the basic volume for each channel 3/4. Turn this switch on (☑) if you hear distortion.

Note: Turn the level knob to minimum before toggling the [GAIN] switch on (☑) and off (☐). Otherwise, noise may be produced.

Stereo output (Phone jack, unbalanced) for connection of an amplifier or another unit, e.g. a second mixer.

Stereo output: Used to connect to another mixer or recorder. The signal output from this jack is not affected by the [TO PC] slide switch or the MAIN MIX [🔊] knob.

Phone/Monitor Output (¼-inch jack) for connection of stereo headphones (minimum impedance 8Ω) for monitoring the sum signal [independent of the PHONES/MONITOR control].

Gain Control To adjust the input amplification, for channel CH 1 and channel CH 2.

Equalizer To adjust the high frequencies "HIGH" and low frequencies "LOW", for each of the input channels CH1 and CH2.

Pan Control For channels CH1 and CH2, to send the mono signal in, creating a stereo field.

Level Peak Indication, for channel CH1 and CH2.

Level Control For channels CH1 and CH2.

HEADSET Connection for the MIC and PHONES.

Headset microphone [TO CH1 🎤] input jack: For connecting to the microphone for your headset. The audio input here is sent to channel 1.

Note: If a microphone is connected to the [HEADSET] microphone input jack, the sound from the microphone or instrument connected to the CH-1 input jack on channel 1 is cut off.

Headset headphones [🎧] output jack: For connecting to the headphone for you headset. The same sound as for the headphone [🎧] output jack is output.

Note: If a headphone plug is connected to the [HEADSET] headphones [🎧] output jack, the sound output from the headphones [🎧] output jack is cut off.

AUX/MP3 input Jack (⅛-inch jack): This is an auxiliary input jack. It supports a stereo plug. You can connect a smart phone, MP3 player or other device and use applications to trigger sound effects or background music. Use the controls on the connected device to adjust volume.

TO PC slide switch Select the audio to send to the computer

[DRY CH 1-2]: This switch enables the audio to be sent from channel 1 and 2 directly to the computer. The audio levels sent to the computer from CH1 and CH2 can be adjusted by the Gain and Level pots for those channels. The audio is routed to channels 1 and 2 (guitar and vocal, etc.) can be recorded separately, as with an audio interface.

[INPUT MIX]: The audio input into the mixer and is mixed in stereo, is then sent to the computer.

The Audio input from the computer is not sent back to the computer.

[LOOPBACK]: The audio input is routed to the mixer and the audio played on the computer is mixed in stereo and then sent to the computer. This setting is used primarily for web casting.

Note: To prevent feedback when using audio recording/playback software, use either [DRY CH 1-2] or [INPUT MIX]





Level control for channel CH3-4

Level control for USB playback.

POWER switch of the mixer.

POWER ON indication.

USB recording level meter If the level of the audio sent to the computer exceeds -20dBV, the green led light up; If the level reaches 3dB before clip level, the red led light up. To send an appropriate audio level to the computer, adjust the audio level of each channel until the green led remains lit and the red led flashes only momentarily when there is an extreme audio level present.

Monitor Mute switch When this switch is on (), the audio input to channels 1 and 2 are muted from the MAIN MIX  output jack, the HEADSET  output jack, and PHONES  output jack (direct monitoring is OFF).

Level control PHONES MONITOR For the headphone output PHONES MONITOR and [HEADSET] headphones  output jack.

MAIN MIX control Allows you to set the level of the output signal sent via the outputs MAIN MIX, AUX out and the USB port.

OPERATION WITH A COMPUTER

1. When operating the mixer with a computer, either use the audio software supplied with the operating system or audio software installed additionally. Various programs for audio reproduction/ recording are available on the Internet free of charge.
2. Boot up the computer and connect the USB jack to a USB port at the computer via the USB cable provided. The USB interface of the mixer is recognized by the computer as an external unit for audio input and audio output, depending on the operating system e.g. as "USB Audio CODEC". The required drivers (standard drivers of the operating system) are available on the computer.

Note: If not all drivers required are available on the computer, install them, e.g. via the original CD of the operating system. If necessary, restart the computer after installation.

3. Activate the audio program used and make the necessary adjustments for the audio reproduction via the mixer or audio recording from the mixer.
4. If no audio recording or audio reproduction is possible, check in the system settings of the computer if the USB interface has been selected for the audio input or audio output.

Hint: If the mixer is connected both to a computer and to any units, which are earth, grounded via their mains cables (e.g. amplifiers), ground loops may occur due to hum interference. To eliminate them, the mixer can be connected to the respective unit via a ground isolator.

MIXING AUDIO SOURCES

The following steps merely serve as an aid, for basic setup, other methods are also possible.

As a basic setting first:

1. Set all controls GAIN, EQ and PAN to mid-position.
2. Turn all control LEVEL back to the left stop.
3. To adjust a mono channel to an optimum level, feed an audio signal to the channel and turn up its control LEVEL approximately to mid-position. Adjust the control GAIN of the channel so that the clip light activates on peak levels. Then adjust the sound with the controls EQ: High for the high frequencies, LOW for low the bass frequencies. As the sound adjustments affect the channel level, readjust the gain adjustment, if necessary.
4. Then turn the control LEVEL back to the stop and make the same adjustments for the second mono channel.
5. For the sound adjustment of a stereo channel turn the controls LEVEL of the remaining channels back to the stop and turn up the control LEVEL of the stereo channel so that the sound can be optimized.
6. For the mono channels place the mono signals in the stereo sound with the PAN controls.
7. Adjust the desired overall volume with the control MAIN MIX. However, if the output level of the mixer is too high for the following unit, the sum signal must be adjusted to a correspondingly lower level.

APPLICATIONS

This compact 4-channel audio mixer with USB interface is suited for universal applications, e.g. for audio recording on the computer. The mono input channel allows connecting a (phantom-powered) microphone; the stereo input channel allows connecting an audio source with line signal level. In addition, the mixer is provided with connections for a recorder and headphones. The mixed signal is sent to the output via ¼-inch jacks and the USB port. It is also possible to use the USB port as an input to transfer audio data from the computer to the mixer. When connecting the mixer to a computer, power is supplied via the USB connection. When operating the mixer without a computer, either use a suitable power supply unit with USB connection to operate the mixer.

WARRANTY INFORMATION

Limited Warranty

Applied Research and Technology will provide warranty and service for this unit in accordance with the following warrants:

Applied Research and Technology, (ART) warrants to the original purchaser that this product and the components thereof will be free from defects in workmanship and materials for a period of **three** years from the date of purchase. Applied Research and Technology will, without charge, repair or replace, at its option, defective product or component parts upon prepaid delivery to the factory service department or authorized service center, accompanied by proof of purchase date in the form of a valid sales receipt.

Exclusions

This warranty does not apply in the event of misuse or abuse of the product or as a result of unauthorized alterations or repairs. This warranty is void if the serial number is altered, defaced, or removed.

ART reserves the right to make changes in design or make additions to or improvements upon this product without any obligation to install the same on products previously manufactured.

ART shall not be liable for any consequential damages, including without limitation damages resulting from loss of use. Some states do not allow limitations of incidental or consequential damages, so the above limitation or exclusion may not apply to you. This warranty gives you specific rights and you may have other rights, which vary, from state to state.

For units purchased outside the United States, an authorized distributor of Applied Research and Technology will provide service.

SERVICE

The following information is provided in the unlikely event that your unit requires service.

1. Be sure that the unit is the cause of the problem. Check to make sure the unit has power, all cables are connected correctly, and the cables themselves are in working condition. You may want to consult with your dealer for assistance in troubleshooting or testing your particular configuration.
2. If you believe that the ART unit is at fault, go to **www.artproaudio.com**.
3. Select "*Support*", then "*Return Authorization Request*" to request a return authorization number.
4. If you are returning the unit for service, pack the unit in its original carton or a reasonable substitute. The original packaging may not be suitable as a shipping carton, so consider putting the packaged unit in another box for shipping. Print the RA number clearly on the outside of the shipping box. Print your return shipping address on the outside of the box.
5. Include, with your unit, a note with the RA number and your contact information, including a return shipping address (we cannot ship to a P.O. box) and a daytime phone number, and a description of the problem, preferably attached to the top of the unit. Also include a copy of your purchase receipt.

Please fill in the following information for your reference:

Date of purchase: _____

Purchased from: _____

Serial Number: _____

SPECIFICATIONS

Input Connections	XLR balanced /¼-inch balanced “Combo” jack (Ch1 input) XLR balanced /¼-inch unbalanced “Combo” jack (Ch2 input) ¼-inch balanced or unbalanced (Ch3-Ch4 inputs) ⅛-inch (Aux/MP3), ⅛-inch (Headset microphone)
Output Connections	¼-inch TRS balanced (Main Mix outputs) ¼-inch TRS stereo (Stereo output) ⅛ + ¼-inch TRS stereo (Phones/Monitor output)
Input Impedance	240k Ohms (Inst-HiZ), 20k Ohms (Line) (Ch1-Ch2, Ch3-Ch4 1/4-inch inputs) >4k Ohms (Ch1-Ch2 XLR input)
Output Impedance	440 Ohms (balanced 1/4"), 220 Ohms (unbalanced 1/4-inch) (Main Mix) 100 Ohms (Monitor output) 2k Ohms (Stereo output)
Frequency Response	20 Hz – 20 kHz (+0, -1 dB)
THD	<0.02% @ 1 kHz
CMRR	>52dB typical
Phase Response	All connections are phase coherent
Signal to Noise Ratio	>90dB typical (Ref 0dBu)
Equivalent Input Noise	-120dBu typical (XLR balanced, max gain), -95dBu typical (¼-inch)
Maximum Input Level	+8dBu (XLR input), +16dBu (¼-inch input)
Maximum Output Level	+15dBu (Main Mix outputs), +15dBu (Monitor output), +12dB (Stereo output)
Maximum Gain (In to Main Out)	+60dB (XLR), +47dB (¼-inch) (Ch1 input) +55dB (XLR), +37dB ¼-inch (INSTR.-HIZ) (Ch2 input) +5dB (¼-inch) (Ch3-Ch4) inputs
(In to USB)	+46dB CH1 (XLR) balanced, +40dB CH2 (XLR) balanced +32dB CH1 (¼-inch input balanced, +17dB CH2 (¼-inch input balanced) +33dB CH1 (¼-inch unbalanced), +23dB CH2dB (¼-inch unbalanced) +46dB (⅛-inch) (MIC to CH1) -8dB (¼-inch) (CH3-CH4) -8dB (⅛-inch) (AUX INPUT)
(USB to Out)	+18dB (Main Mix outputs), +18dB (Monitor output)
Phantom Power	Switch selectable, +48V DC, filtered, current limited
A/D-D/A	16 Bit, 44.1 kHz or 48 kHz, USB selectable from computer 0.4 ms A/D latency @ 44.1 kHz
Computer Interface	USB Class compliant plug-and-play Mac and PC interface
Chassis Type	All steel black finish
Power Requirements	Via USB port (5V/500mA) of the computer or via USB power adaptor provided and connected to AC100-240V 50/60Hz
Dimensions (HWD)	1.75-inch x 5.1-inch x 7.5-inch 45mm x 130mm x 191mm
Weight	1.56 lbs. (.71 kg)

Note: 0 dBu = 0.775Vrms

ART maintains a policy of constant product improvement. Therefore, specifications are subject to change without notice.
Go to www.artproaudio.com for the latest information and support.



www.artproaudio.com
E-mail: support@artproaudio.com

© 2016 Applied Research & Technology

USB MIX4

FOUR CHANNEL MIXER WITH USB INTERFACE

185-5004-101