

AD 5 CX

Sd:	78 cm ²
Vas:	5.33 l
Cms:	-
Cas:	-
Mmd:	-
Mms:	-
Rms:	-
Fs:	69 Hz
Bl:	4.35 N/A
Re:	2.80 ohm
Le:	0.59 mH
Qms:	4.00
Qes:	-
Qts:	0.50
V/C l:	17.00 mm
Xmax:	10.00 mm
Pmax:	50 W
dBSpl:	89.0 dB

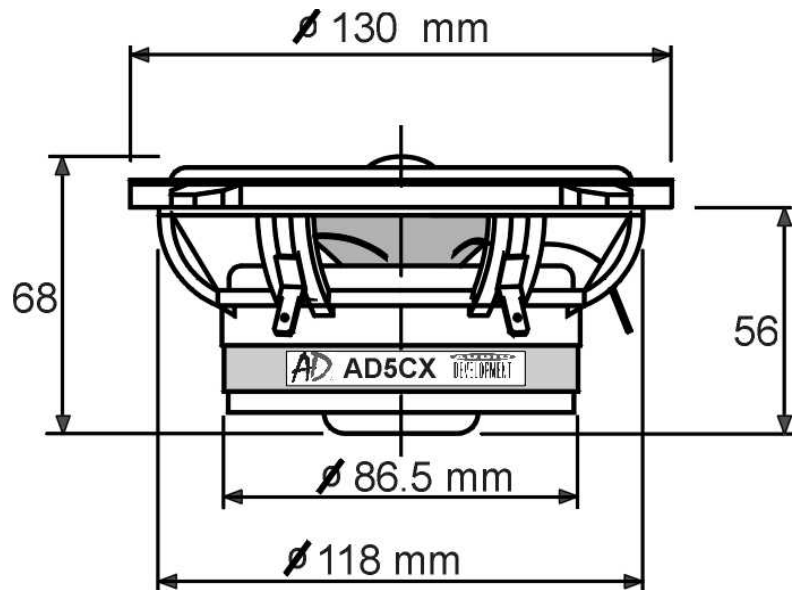

W 5 CX IMPEDANCE

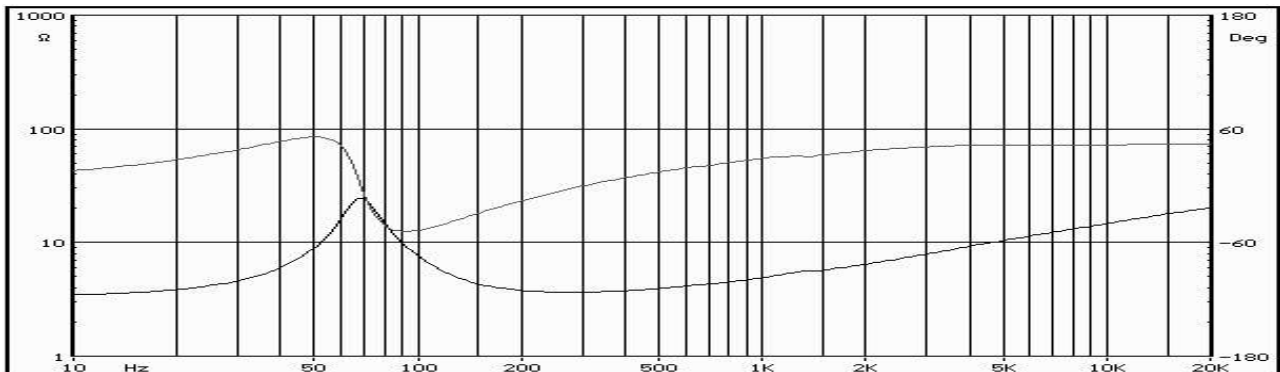

DESIGN FEATURES

- CONE: Double layer fibreglass with rubber suspension.
- WOOFER VOICE COIL: Pure copper wire on aluminium former (∅ 26 mm).
- BASKET: Owner's design, a PPO chassis injected with fibreglass, in order to low down undesired distortions.
- TWEETER: Silk dome 3/4" diameter, with neodymium magnet and Ferrofluid cooling

The decision to offer a line of coaxials derived from the TREND line, could sound unusual, looking at the common conception of these products, seen often as synonymous of economic.

We believe that quality could not be abandoned even in this choice, sometimes forced due to installation problems, sometimes chose to complete an existing front system of good quality.

Whatever is the reason, the solutions for a high quality coaxial are restricted, and in these the TREND line of AD is one of them.

Phase and impedance curves are measured after 20 hours burn-in at 30 W RMS, so are the T / S parameters. Due to the continue research and development, these information are subject to change without notice.