

Model No: PLS-50F25AL01-04

Rev: 2

Product Line: Tymphany

Last Update: 2016-03-24 20:46:47

Product Description

This 2 inch 4 ohm member of the PLS family sets a high standard for compact full range drivers intended for applications such as television soundbars and compact music systems. Design features in this family include a stiff steel basket with venting under the spider to aid cooling of the motor, a ferrite magnet motor with copper cap to lower coil inductance, providing low distortion at low frequencies and extended high frequency response. A black anodized aluminium cone is employed, along with a black anodized aluminium dust cap coupled directly to the voice coil. Additionally, the cones come equipped with special-designed large roll rubber surrounds, which allow for a dynamic linear response at high excursion.



Mechanical Drawing

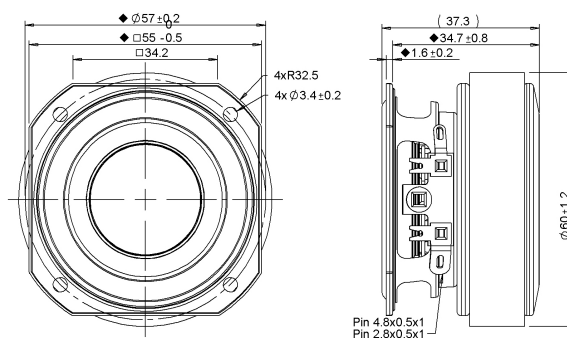

Specifications

DC Resistance	Revc	Ohms	3.44	5.0%	Energy Bandwidth Product	EBP	(1/Qes)*fs
Minimum Impedance	Zmin	Ohms	4.42	7.5%	Moving Mass	Mms	g
Voice Coil Inductance	Le	mH	0.03		Suspension Compliance	Cms	um/N
Resonant Frequency	Fs	Hz	171.46	15%	Effective Cone diameter	D	cm
Mechanical Q Factor	Qms		5.1		Effective Piston Area	Sd	cm ²
Electrical Q Factor	Qes		0.89		Effective Volume	Vas	L
Total Q Factor	Qts		0.76		Motor Force Factor	BL	Tm
Ratio Fs/Qts	F	Fs/Qts	225.9		Motor Efficiency Factor	β	(T*M ²)/Ohms
Half Space Sensitivity @2.83V	db@2.83V/1M	dB	84.13	+/- 1.0db	Voice coil former Material	VCfm	ASV
Half Space Sensitivity @1W/1M	db@1W/1M	dB	81.6	+/- 1.0db	Voice coil inner diameter	VCd	mm
Gap Height	Gh	mm	2		Rated Noise Power	P	W
Maximum Linear Excursion	Xmax	mm	2.2		Test Spectrum Bandwidth		150Hz~20KHz
Ferrofluid Type	FF				Driver Size	Inch	2 in
Driver Mass	Kg		0.32				

Frequency and Impedance Response

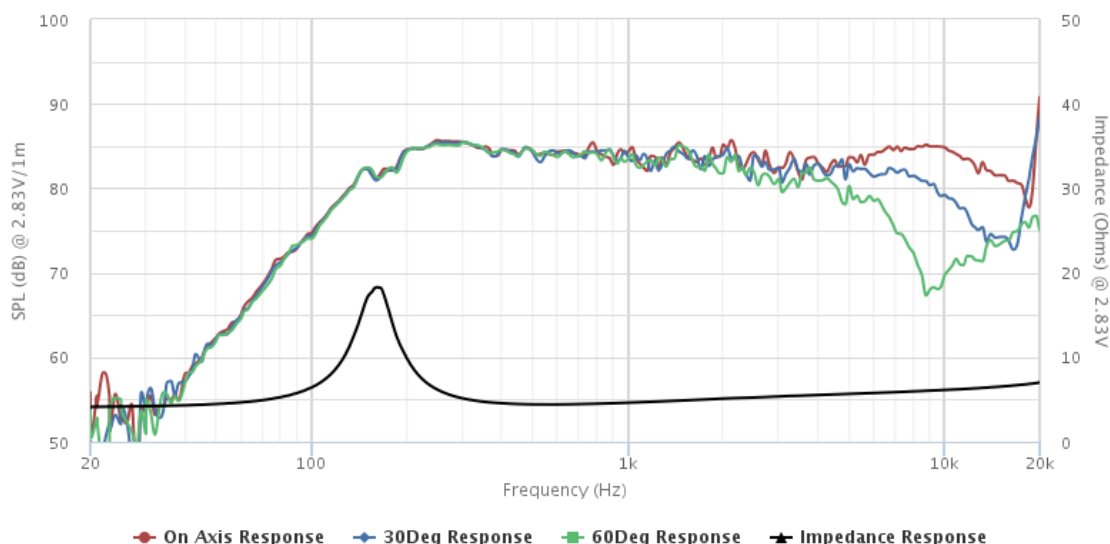

Highcharts.com