

GENERAL CHARACTERISTICS

Nominal Overall Diameter	385	mm
Nominal Voice Coil Diameter	38	mm
Magnet Weight	826	g
Flux Density.....	1.26	T

THIELE-SMALL PARAMETERS

Voice Coil DC Resistance	R_E	6.50	Ω
Resonance Frequency	f_s	77.0	Hz
Mechanical Q Factor.....	Q_{MS}	9.63	
Electrical Q Factor.....	Q_{ES}	1.36	
Total Q Factor	Q_{TS}	1.18	
Mechanical Moving Mass	M_{MS}	42.0	g
Mechanical Compliance	C_{MS}	103.0	μm/N
Force Factor	$B \times l$	10.14	Wb/m
Equivalent Acoustic Volume.....	V_{AS}	82.1	lt.
Maximum Linear Displacement	X_{MAX}	1.00	mm
Reference Efficiency	η_0	2.62	%
Diaphragm Area	S_D	754.7	cm ²
Losses Electrical Resistance.....	R_{ES}	50.0	Ω
Voice Coil Inductance @ 1kHz	L_E	0.90	mH

CONSTRUCTIVE CHARACTERISTICS

Magnet.....	AlNiCo
Voice Coil Winding.....	Copper
Voice Coil Former.....	Kapton
Cone	Paper
Surround.....	Integrated Paper
Dust Dome	Solid Paper
Basket	Pressed Sheet Steel

ELECTRICAL CHARACTERISTICS

Nominal Impedance.....	8	Ω
Rated Power (DIN 45573 - IEC 268.5)	50	W
Musical Power (DIN 45500)	100	W
Sensitivity @ 1 W, 1 m	96.8	dB

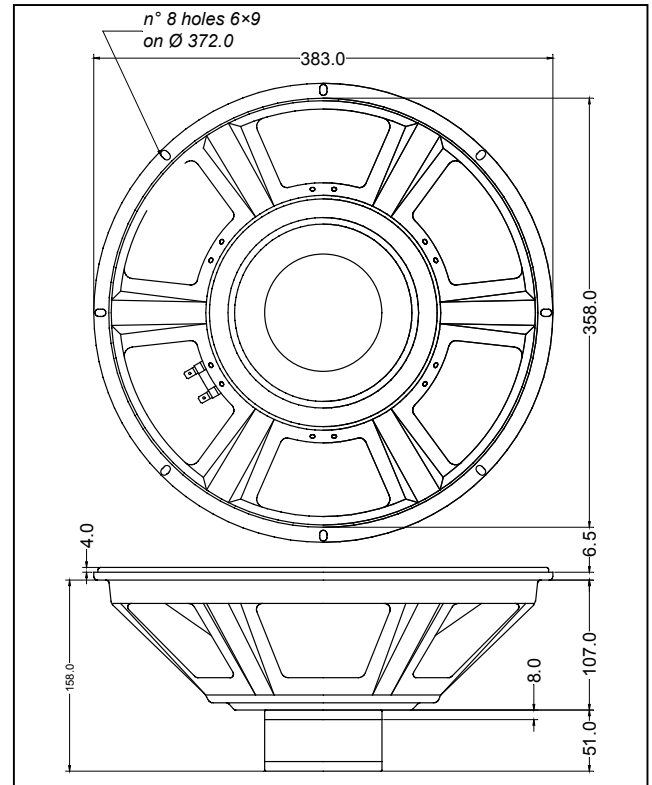

Frequency Response on IEC Baffle (DIN 45575) @ 1 W, 1 m - Impedance

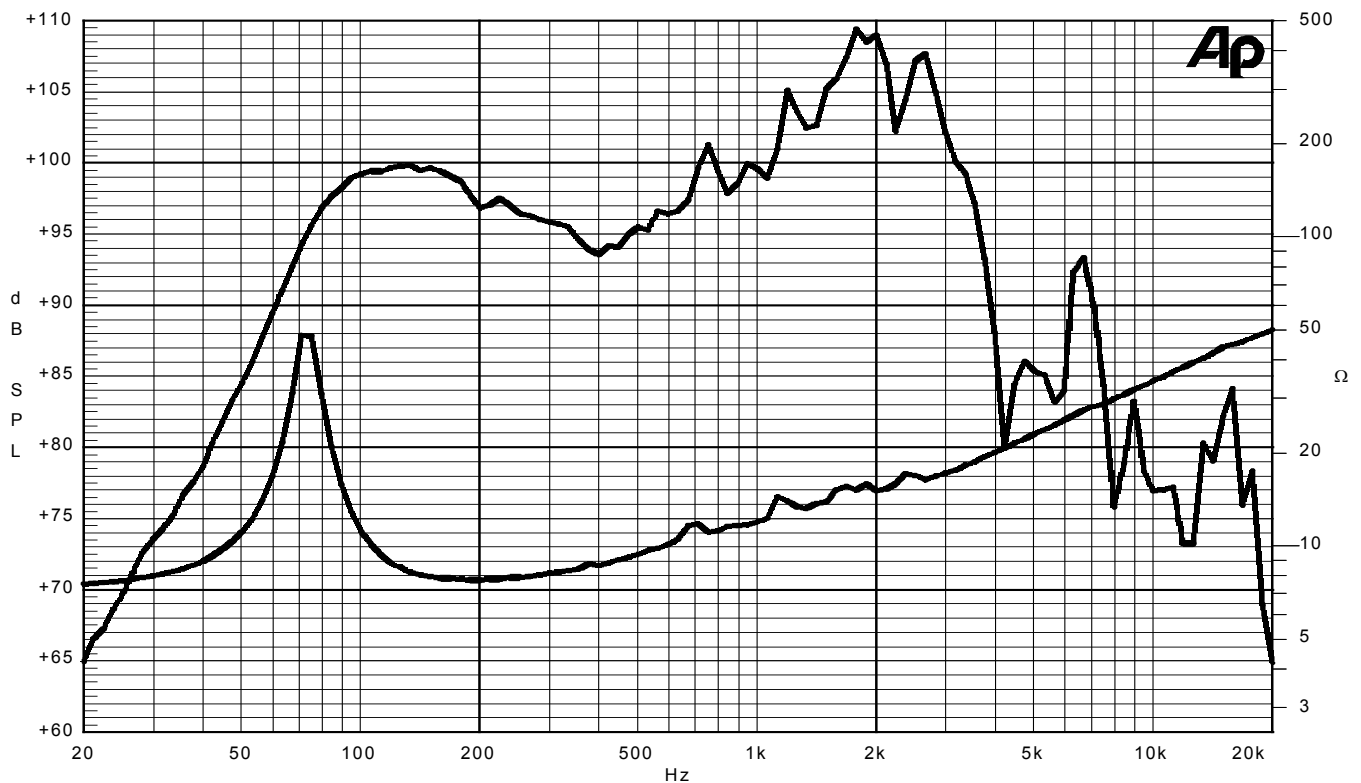

Due to continuing product improvement, the features and the design are subject to change without notice.

31/03/2005