

#### GENERAL CHARACTERISTICS

Nominal Overall Diameter .....	385	mm
Nominal Voice Coil Diameter .....	75	mm
Magnet Weight .....	360	g
Flux Density.....	1.17	T
Weight.....	4.00	Kg

#### THIELE-SMALL PARAMETERS

Voice Coil DC Resistance .....	$R_E$	3.13	Ω
Resonance Frequency .....	$f_s$	44.0	Hz
Mechanical Q Factor.....	$Q_{MS}$	7.20	
Electrical Q Factor.....	$Q_{ES}$	0.37	
Total Q Factor .....	$Q_{TS}$	0.35	
Mechanical Moving Mass .....	$M_{MS}$	69.4	g
Mechanical Compliance .....	$C_{MS}$	190	μm/N
Force Factor .....	$B \times l$	12.69	Wb/m
Equivalent Acoustic Volume.....	$V_{AS}$	152.0	lt.
Maximum Linear Displacement ....	$X_{MAX}$	+/-4.0	mm
Reference Efficiency .....	$\eta_0$	3.32	%
Diaphragm Area .....	$S_D$	754.8	cm <sup>2</sup>
Losses Electrical Resistance.....	$R_{ES}$	60.7	Ω
Voice Coil Inductance @ 1kHz .....	$L_E$	0.61	mH

#### CONSTRUCTIVE CHARACTERISTICS

Magnet.....	Neodymium
Voice Coil Winding.....	Aluminium
Voice Coil Former.....	Kapton
Cone .....	Paper
Surround.....	Treated Cloth
Dust Dome .....	Solid Paper
Basket .....	Pressed Sheet Steel

#### ELECTRICAL CHARACTERISTICS

Nominal Impedance.....	4	Ω
Musical Power .....	700	W
Rated Power* .....	350	W
Sensitivity @ 1 W, 1 m .....	98.3	dB

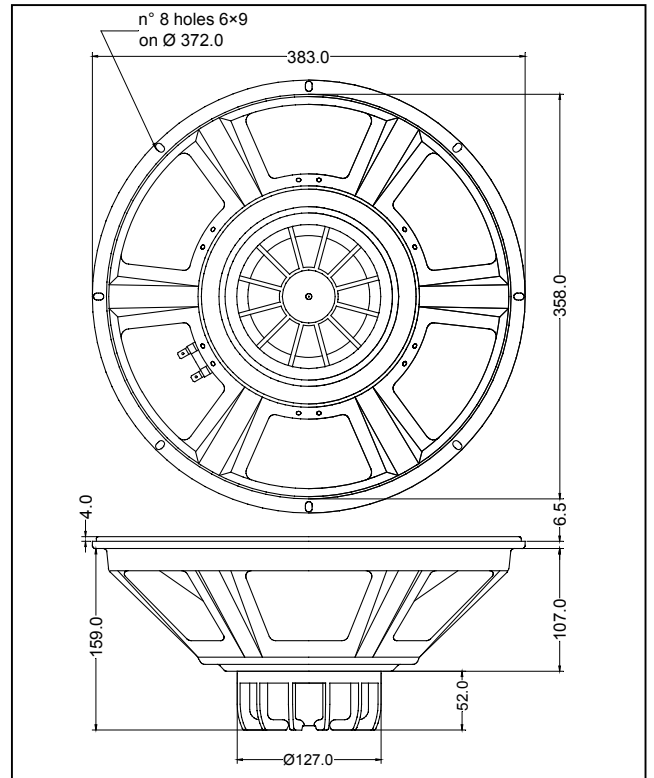

\*rated power measured with 2 hours test with pink noise signal, 6 dB crest factor, loudspeaker mounted on enclosure

Frequency Response on IEC Baffle (DIN 45575) @ 1 W, 1 m - Impedance

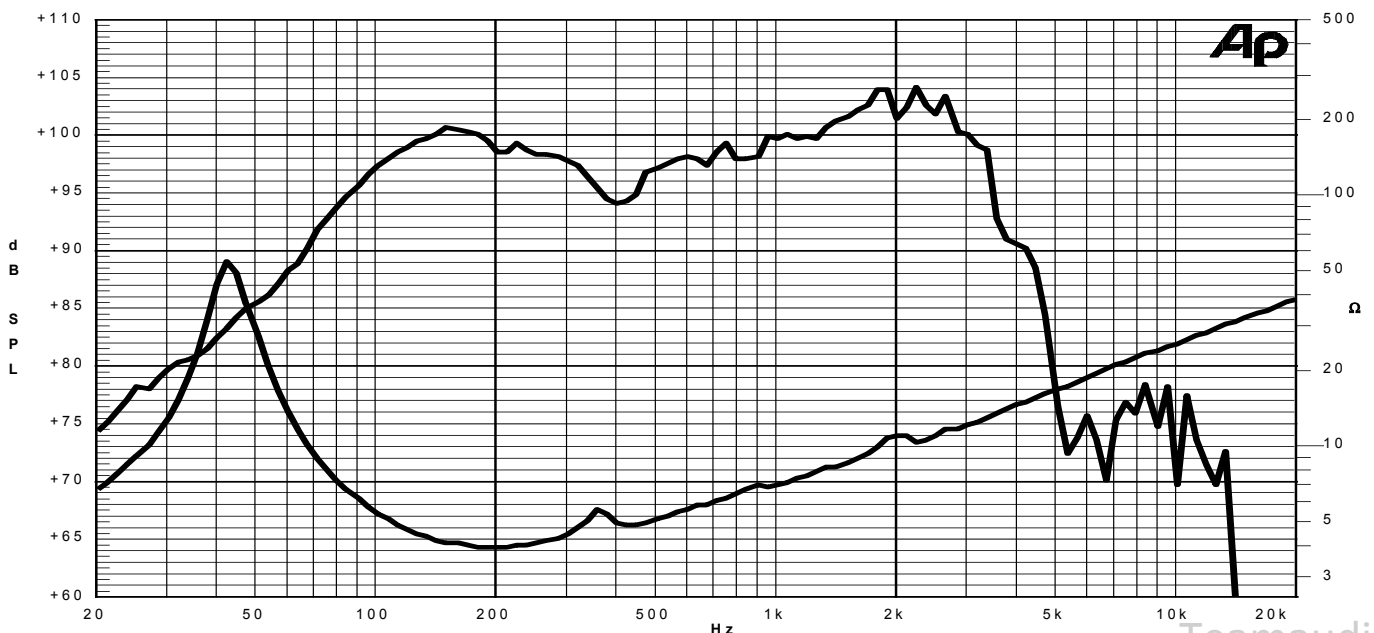

Due to continuing product improvement, the features and the design are subject to change without notice.

11/03/05