

GENERAL CHARACTERISTICS

Nominal Overall Diameter	320	mm
Nominal Voice Coil Diameter	65	mm
Magnet Weight	220	g
Flux Density.....	1.14	T
Weight.....	2.50	Kg

THIELE-SMALL PARAMETERS

Voice Coil DC Resistance	R_E	3.16	Ω
Resonance Frequency	f_s	47.9	Hz
Mechanical Q Factor.....	Q_{MS}	5.44	
Electrical Q Factor.....	Q_{ES}	0.37	
Total Q Factor	Q_{TS}	0.35	
Mechanical Moving Mass	M_{MS}	44.1	g
Mechanical Compliance	C_{MS}	251	μm/N
Force Factor	$B \times l$	10.61	Wb/m
Equivalent Acoustic Volume.....	V_{AS}	99.9	lt.
Maximum Linear Displacement	X_{MAX}	+/-2.0	mm
Reference Efficiency	η_0	2.83	%
Diaphragm Area	S_D	530.9	cm ²
Losses Electrical Resistance.....	R_{ES}	46.2	Ω
Voice Coil Inductance @ 1kHz	L_E	0.42	mH

CONSTRUCTIVE CHARACTERISTICS

Magnet.....	Neodymium
Voice Coil Winding.....	Aluminium
Voice Coil Former.....	Kapton
Cone	Paper
Surround.....	Treated Cloth
Dust Dome	Solid Paper
Basket	Aluminium Die-Cast

ELECTRICAL CHARACTERISTICS

Nominal Impedance.....	4	Ω
Musical Power	500	W
Rated Power*	250	W
Sensitivity @ 1 W, 1 m	97.7	dB

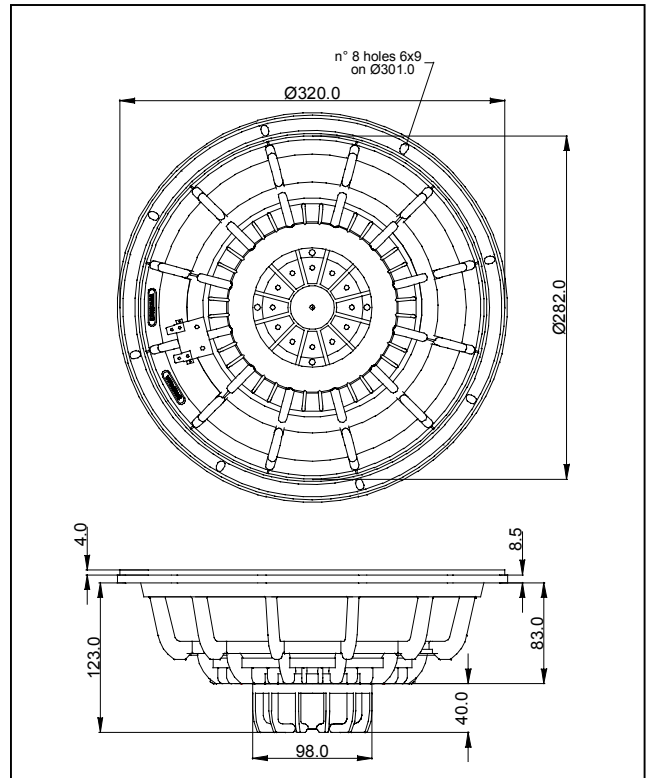

*rated power measured with 2 hours test with pink noise signal, 6 dB crest factor, loudspeaker mounted on enclosure
Thiele-Small parameters measured with LASER system

Frequency Response on IEC Baffle (DIN 45575) @ 1 W, 1 m - Impedance

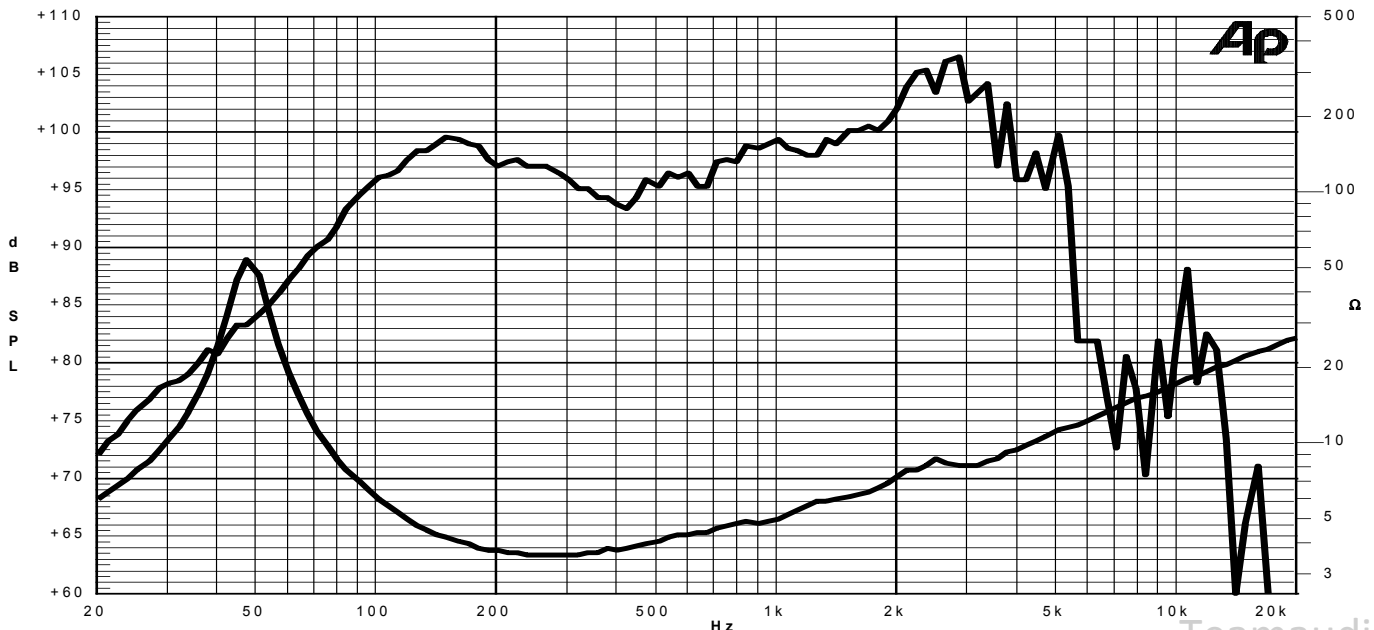

Due to continuing product improvement, the features and the design are subject to change without notice. 17/12/07