

#### GENERAL CHARACTERISTICS

Nominal Overall Diameter .....	320	mm
Nominal Voice Coil Diameter .....	65	mm
Magnet Weight .....	220	g
Flux Density.....	1.14	T
Weight.....	2.50	Kg

#### THIELE-SMALL PARAMETERS

Voice Coil DC Resistance .....	$R_E$	5.46	Ω
Resonance Frequency .....	$f_s$	46.8	Hz
Mechanical Q Factor.....	$Q_{MS}$	12.58	
Electrical Q Factor.....	$Q_{ES}$	0.44	
Total Q Factor .....	$Q_{TS}$	0.43	
Mechanical Moving Mass .....	$M_{MS}$	56.7	g
Mechanical Compliance .....	$C_{MS}$	200	μm/N
Force Factor .....	$B \times l$	14.37	Wb/m
Equivalent Acoustic Volume.....	$V_{AS}$	81.3	lt.
Maximum Linear Displacement ....	$X_{MAX}$	+/-5.0	mm
Reference Efficiency .....	$\eta_0$	1.81	%
Diaphragm Area .....	$S_D$	530.9	cm <sup>2</sup>
Losses Electrical Resistance.....	$R_{ES}$	155.6	Ω
Voice Coil Inductance @ 1kHz .....	$L_E$	1.00	mH

#### CONSTRUCTIVE CHARACTERISTICS

Magnet.....	Neodymium
Voice Coil Winding.....	Copper
Voice Coil Former.....	Kapton
Cone .....	Paper
Surround.....	Treated Cloth
Dust Dome .....	Solid Paper
Basket .....	Aluminium Die-Cast

#### ELECTRICAL CHARACTERISTICS

Nominal Impedance.....	8	Ω
Musical Power .....	500	W
Rated Power* .....	250	W
Sensitivity @ 1 W, 1 m .....	96.4	dB

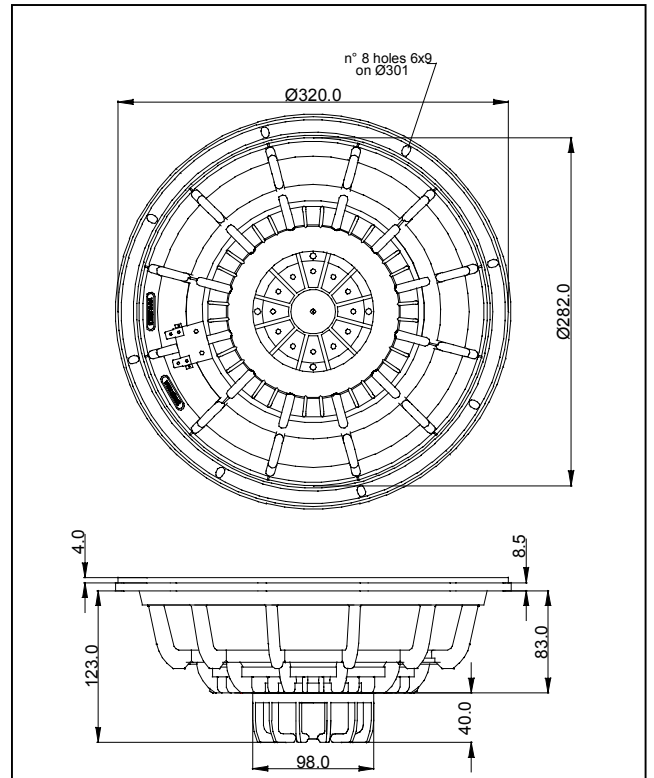

\*rated power measured with 2 hours test with pink noise signal, 6 dB crest factor, loudspeaker mounted on enclosure  
Thiele-Small parameters measured with LASER system

Frequency Response on IEC Baffle (DIN 45575) @ 1 W, 1 m - Impedance

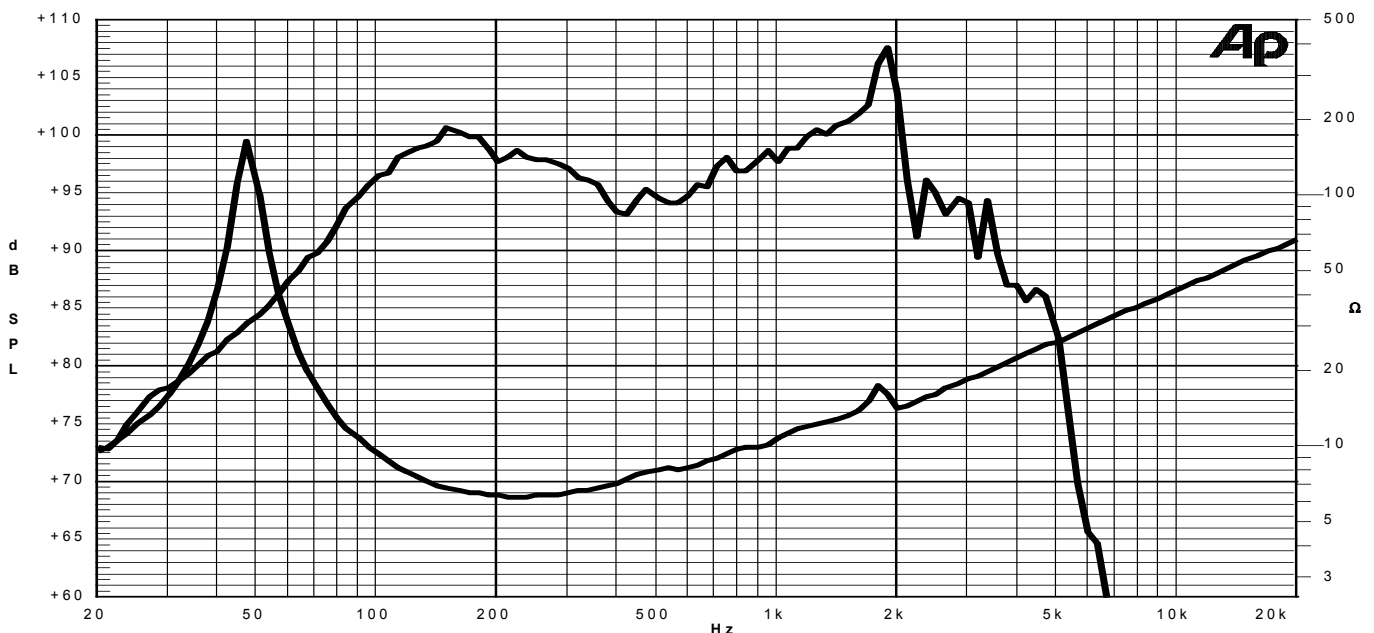

# 12 B 2,5 PL

12" speaker - 2,5" voice coil

## GRAPHICS AND MEASUREMENTS

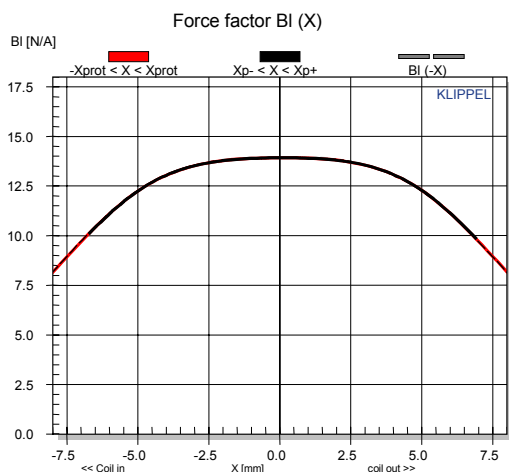

BI(X): force factor variation with voice coil displacement

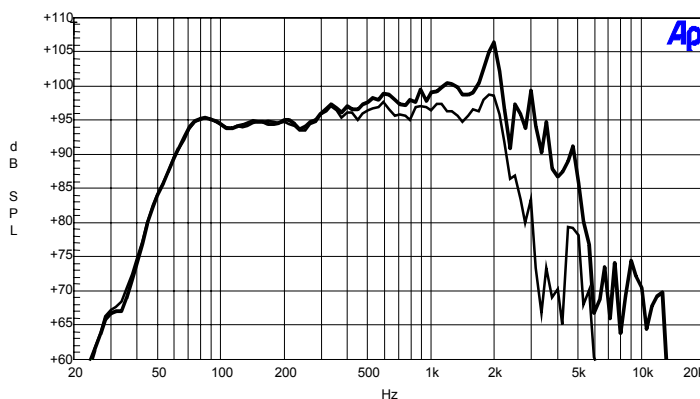

Frequency Response: enclosure volume 45l, port tuning 58Hz (thick curve on axis, thin curve 30° off axis)

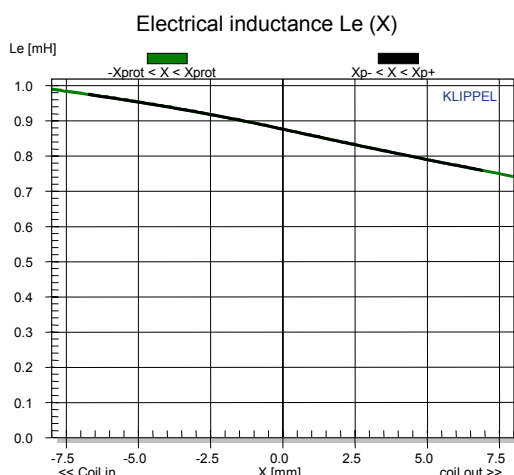

Le: electrical inductance variation with voice coil displacement

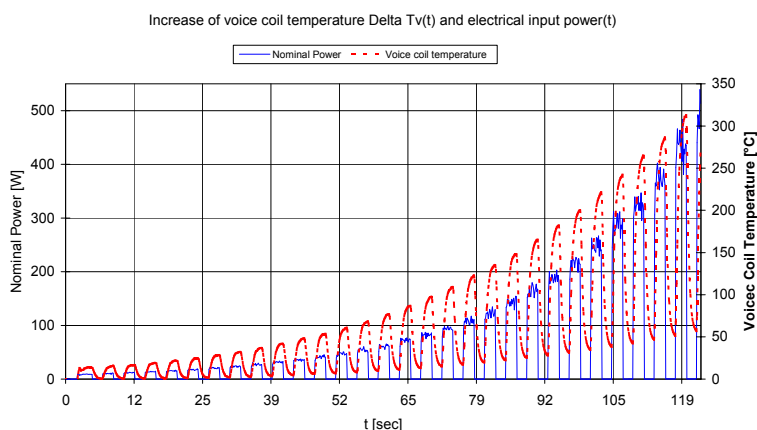

Power test done with intermittent excitation, ON interval 2min, duty cycle 50%, pink noise signal 6dB crest factor with frequency range 50-2000Hz.

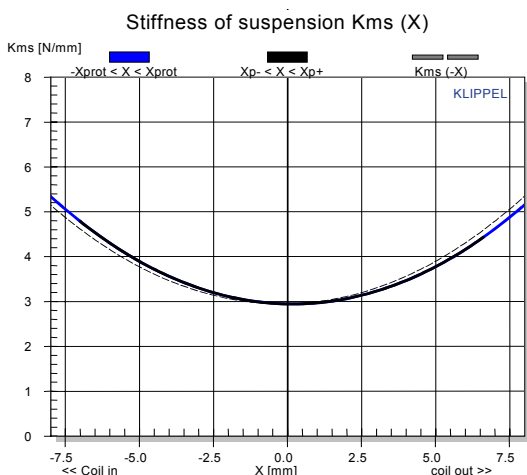

K<sub>ms</sub>: stiffness of suspension variation with voice coil displacement

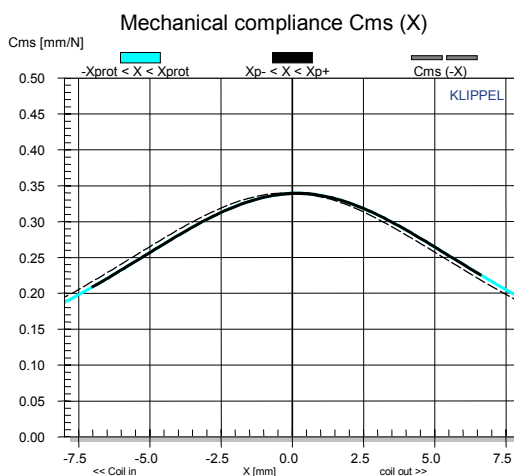

C<sub>ms</sub>: mechanical compliance variation with voice coil displacement