



cerasonar  
invisible speakers



### *Passion is our spirit*

At cerasonar, the pursuit of real sound and the love for perfection in details is a family matter. More than 40 years ago, Ulrich Ranke began to develop special loudspeakers that enable pure listening pleasure in technically and acoustically demanding situations. Today, together with his sons, cerasonar grew into a family owned company that believes in „made in Germany“ and serves its clients in more than 31 countries on 5 continents.

cerasonar gives you the freedom to enjoy superior sound in any situation – without cable clutter and loss of space. The loudspeaker are fully integrated into the walls or ceilings and totally invisible. As part of the house technology they are the optimal complement for any SmartHome project.

For about 15 years now, we have been involved in the further development of bending wave radiators, a technology that is only now being noticed, although it was already invented by Siemens in the 1930s. At that time, the conditions were not yet in place for success; you could say the invention came too early. There were no high-power magnets (neodymium) or stable and powerful amplifiers yet. In the end, the road to market maturity only began about 20 years ago. The way these loudspeakers work is fundamentally different, i.e. in contrast to the known way loudspeakers work, a bending surface is set in motion (modes). The sound advantages are enormous besides the completely invisible installation.

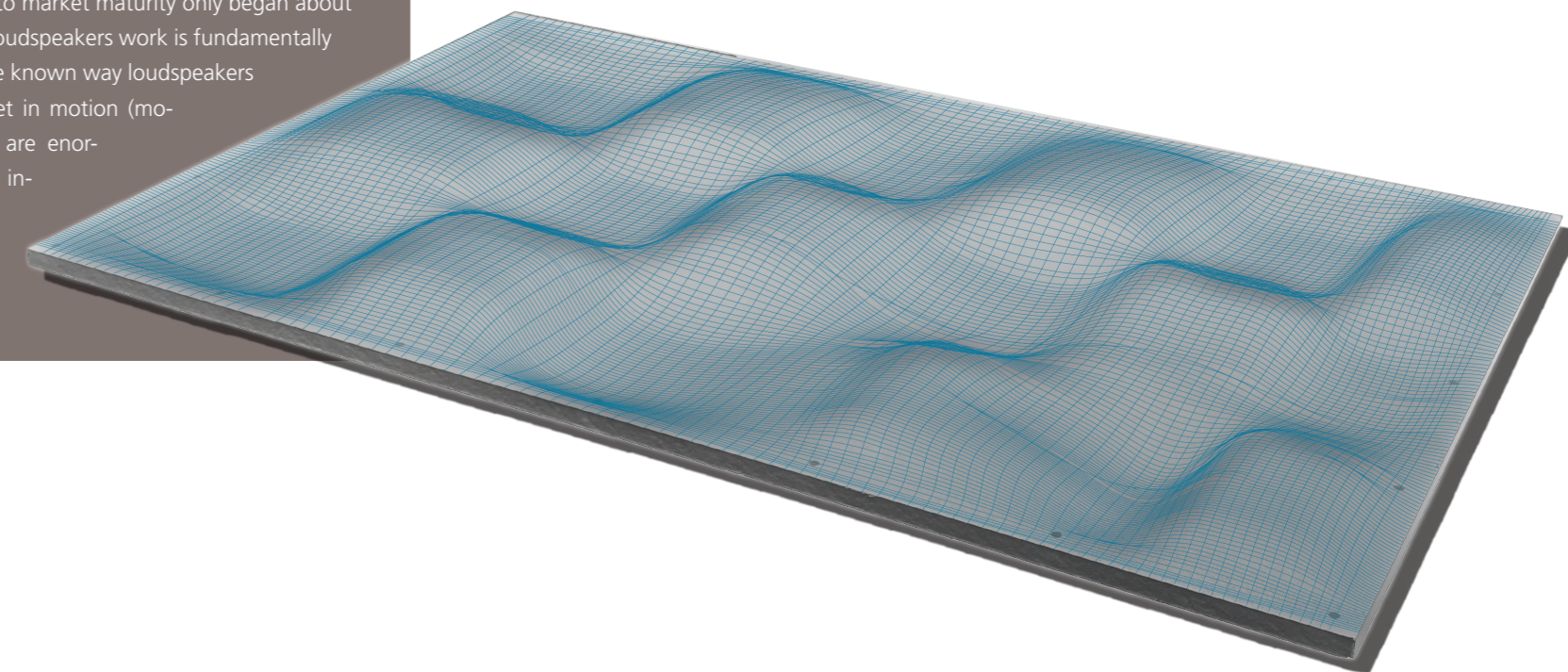



## Handcrafted *in Germany*

Traditionally, loudspeaker production is handcraft, this has changed little until today and will definitely not change with us. In order to monitor the respective quality requirements, we still manufacture essential parts ourselves. cerasonar speakers are carefully monitored manually during the assembly process and thoroughly checked before being moved from one stage of production to the next. Several production lines provide us with the possibility to grant the drying times needed between the individual production steps.

Beautifully located in the artists' village Worpswede, in the famous Hamme lowlands, you can find our production site in the middle of nature, a wonderful, inspiring spot for design and innovation.

In order to stock sufficient components, we installed our own high-bay warehouse. Absolutely needed, because since 2020, delivery times have virtually exploded.

Further we are proud to have Truaudio as a strong partner for the North and South American market, where the cerasonar technology is living under Wraith invisible speakers.

## Why *cerasonar*?

We specialise in the design and manufacturing of invisible loudspeakers. Through years of experience and a wide selection, we can offer the right product for every project & budget.

With our range of accessories, we can offer a complete system, and can also ensure proper functionality and the best possible sound.

As a German manufacturer, maximum quality is most important to us - this is also how we select our components and try to source them as locally as possible.

With our speakers, the highest possible finish quality can still be produced (Q4). That's why we use an innovative 10 mm foam, with high damping properties and excellent stability. Even several layers of plaster can be applied without affecting the sound quality. Therefore, labour intense measuring and sanding of the plaster is generally not required.



## cerasonar 4062 architect

Power rating	32 w RMS (64 w max)
Impedance	4 ohms
Frequency range	120 - 20.000 hz*
Frequency range with cs-500dsp4	100 - 20.000 hz*
max SPL	100 db
Dispersion range	180° x 180° h./v.
Single stereo mode	no
for humid environments	no
Drywall	1- or 2- layered 12,5 mm plasterboard
Installation cut out	35,0 x 57,0 cm
Dimensions	40,0 x 62,0 x 3,0 cm
Weight	1,2 kg

Accessories

- cerasonar protection unit pro 25w
- cerasonar cs-500dsp4 amp
- cerasonar cs-2000dsp4 amp
- (we recommend to use the cs-500dsp4)
- cerasonar frame 4062 architect
- cerasonar frame 4062
- cerasonar backbox 4062



Scan the QR code with your telephone to show the cerasonar installation video

\* depending on installation situation

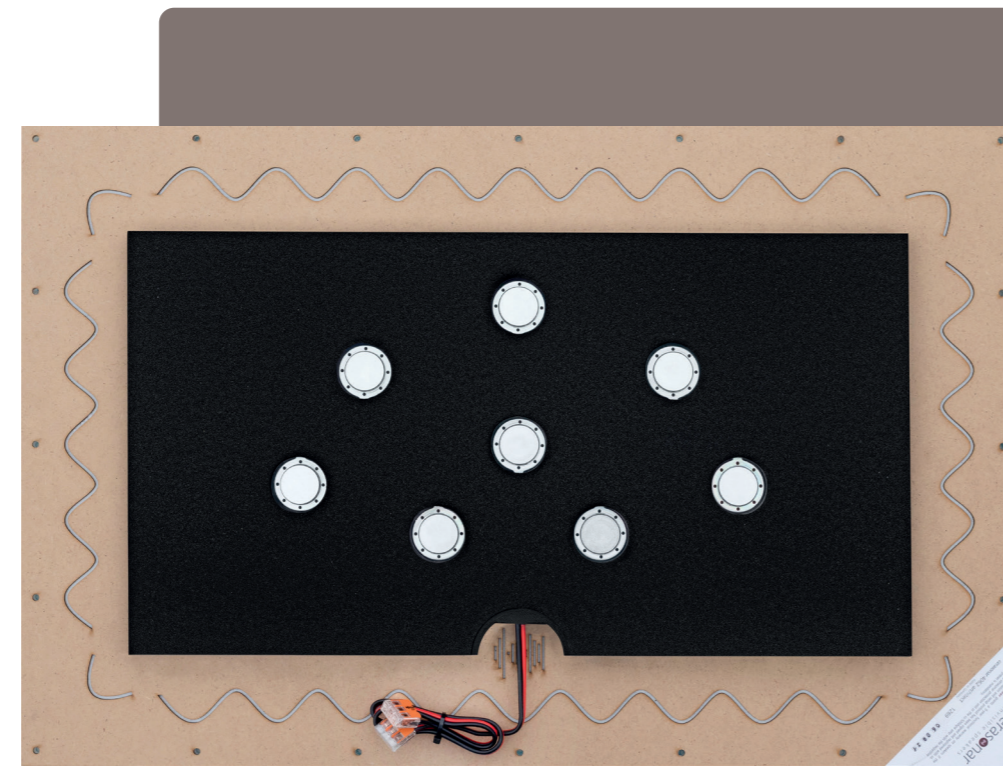

## With 30 mm - the flattest invisible speaker in the world

The development of our 4062 architect was something very special for us. This new loudspeaker is suitable for use in very flat ceilings or walls, e.g. renovations of old buildings that allow only very little depth. This is where every millimetre really counts. Dry construction requires only a thin batten as a substructure, which is fixed directly to the ceiling, covered with plasterboard and the cerasonar invisible speaker.

The cerasonar 4062 architect is only 30 mm thin. This makes it the flattest invisible loudspeaker in the world. The dispersion and thus the homogeneous sound image due to 8 of our new ultra-flat sound exciters, which are equipped with smaller voice coils to be able to reproduce the high-frequency range in even greater detail, is extremely large and thus very pleasant to perceive. Based on the high number of 8 exciters, the power handling is more than sufficient for the application range.

## CAD details:

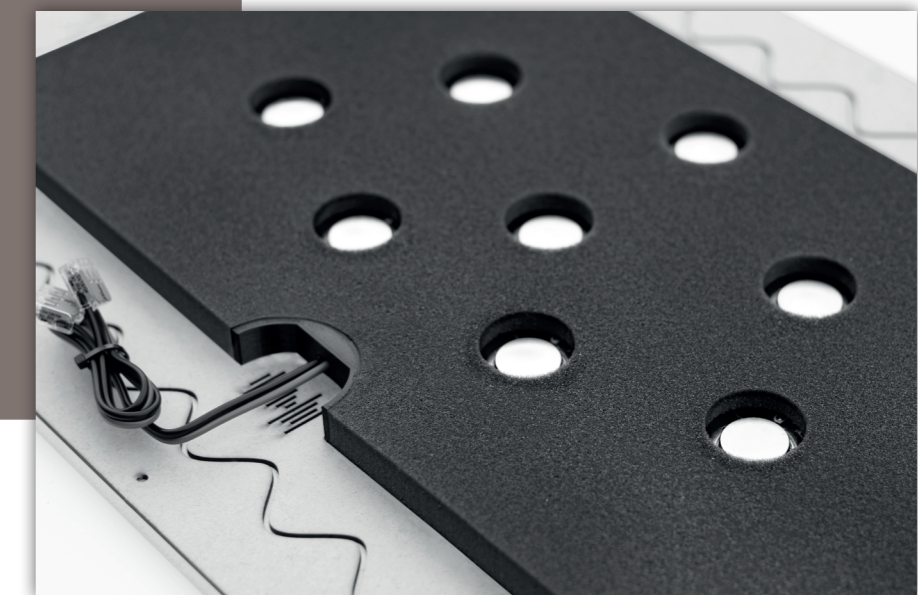
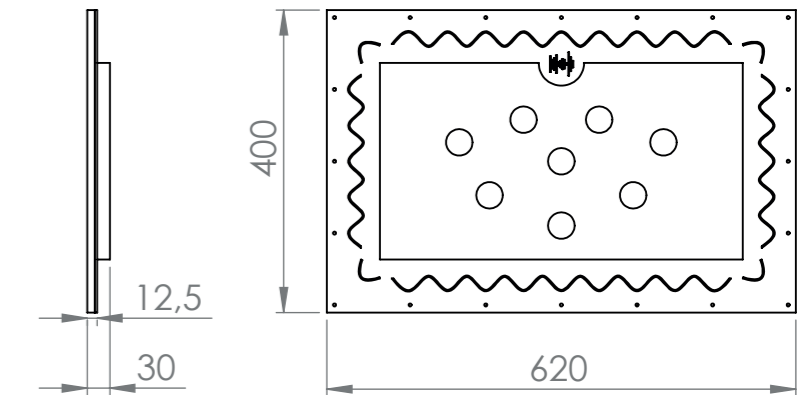

	<b>cerasonar 1520 fit</b>	<b>cerasonar 2525 fit</b>
Power rating	25 w RMS (50 w max)	50 w RMS (100 w max)
Impedance	8 ohms	4 ohms / 2x 8 ohms
Frequency range	100 - 18.000 hz*	100 - 18.000 hz*
Frequency range with cs-500dsp4	80 - 20.000 hz*	80 - 20.000 hz*
max SPL	97 db	100 db
Dispersion range	180° x 180° h./v.	180° x 180° h./v.
Single stereo mode	no	yes
for humid environments	yes	yes
Drywall	1-layered 12,5 mm plasterboard	1-layered 12,5 mm plasterboard
Installation place	in the centre of the plasterboard to improve bass response	in the centre of the plasterboard to improve bass response
Installation cut out	20,0 x 16,5 cm	25,5 x 25,5 cm
Dimensions	23,4 x 16,3 x 5,3 cm	28,9 x 25,3 x 5,3 cm
Weight	0,3 kg	0,6 kg
Accessories	cerasonar protection unit 25w cerasonar cs-500dsp4 amp cerasonar cs-2000dsp4 amp cerasonar frame 1520	cerasonar protection unit 50w or 2x 25w version for single stere mode cerasonar cs-500dsp4 amp cerasonar cs-2000dsp4 amp cerasonar frame 2525



Scan the QR code with your telephone to show the **cerasonar installation video**

\* depending on installation situation

## Our budget friendly series - in the price range of in ceiling speakers

The easy to install and space-saving models of the cerasonar fit series fill even the smallest room with music and life. Whether its the bathroom, kitchen, living room or hallway.

As invisible speakers became more and more popular in humid environment such as bathrooms or swimming pools, spa areas as well as in boats and yachts, we designed this series to be moisture-proof down to the smallest detail. It is extremely stable in rooms with high humidity and guarantees you a very clear and dynamic sound.

The lightweight and shallow manufacture fit series offers you the advantage that it fits precisely into the space of the most common in-wall speakers. Despite its small size, the cerasonar fit series delivers an outstandingly harmonious sound, which is particularly popular in the hotel, tourism and cruise industry for background sound reinforcement.

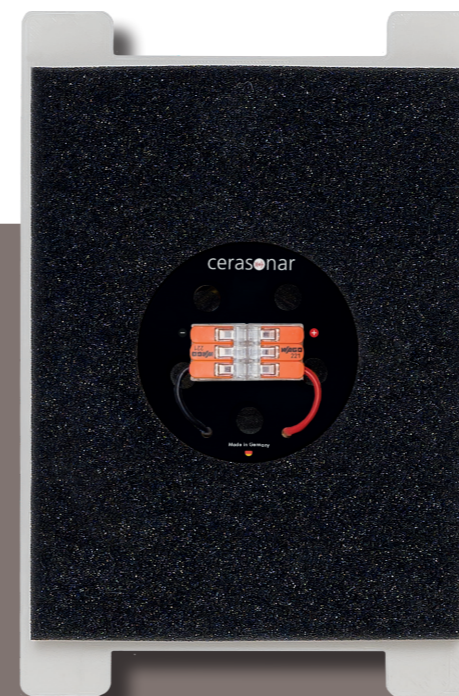

cerasonar 1520 fit

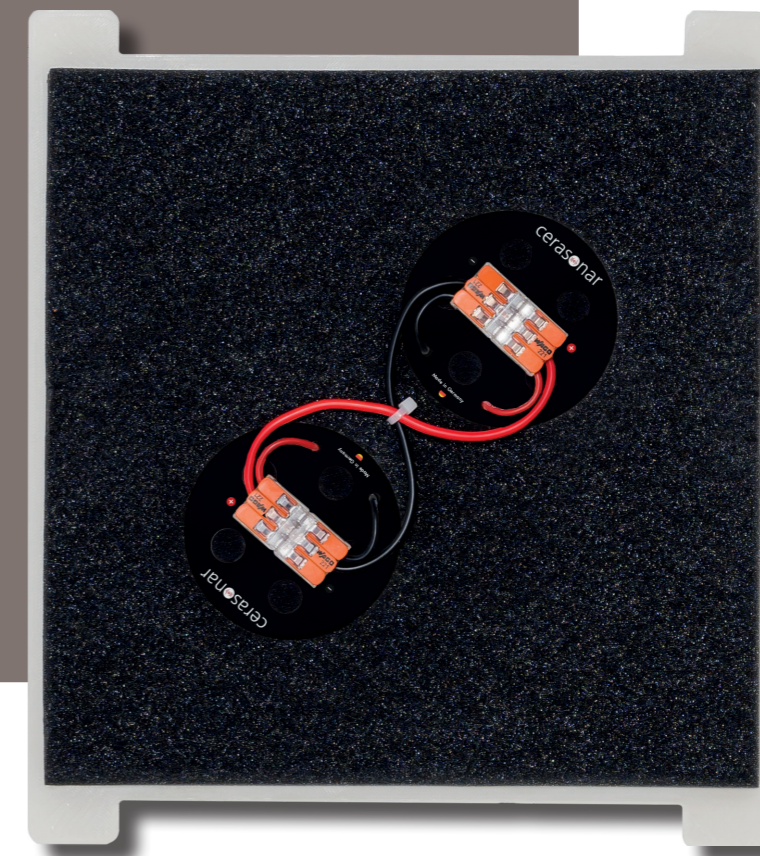

cerasonar 2525 fit

### CAD details:

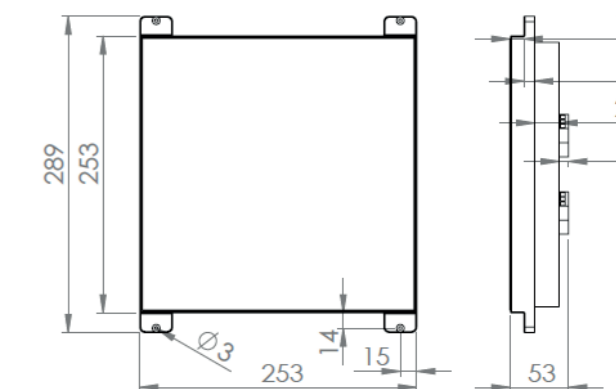
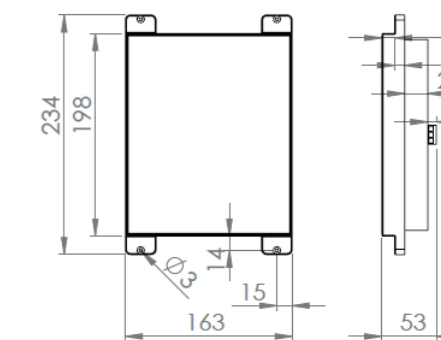

# cerasonar reference

powerful and light - our top selling series

## cerasonar 4062 reference

Power rating	50 w RMS (100 w max)	100 w RMS (200 w max)
Impedance	4 ohms / 2x 8 ohms	8 ohms / 2x 4 ohms
Frequency range	70 - 20.000 hz*	60 - 20.000 hz*
Frequency range with cs-500dsp4	60 - 20.000 hz*	50 - 20.000 hz*
max SPL	105 db	108 dB
Dispersion range	180° x 180° h./v.	180° x 180° h./v.
Single stereo mode	yes	yes
for humid environments	no	no
Drywall	1- or 2- layered 12,5 mm plasterboard	1- or 2- layered 12,5 mm plasterboard
Installation cut out	35,0 x 57,0 cm	55 x 57 cm
Dimensions	40,0 x 62,0 x 5,8 cm	60,0 x 62,0 x 5,8 cm
Weight	1,2 kg	2,1 kg

## cerasonar 6062 reference

Accessories	cerasonar protection unit pro 50w/100w or 2x 25w version for single stereo mode cerasonar cs-500dsp4 amp cerasonar cs-2000dsp4 amp cerasonar frame 4062 cerasonar backbox 4062	cerasonar protection unit pro 50/100w or 2 units for single stereo mode cerasonar cs-500dsp4 amp cerasonar cs-2000dsp4 amp cerasonar frame 6062 cerasonar backbox 6062
-------------	--	--



Scan the QR code with your telephone to show the **cerasonar installation video**



\* depending on installation situation

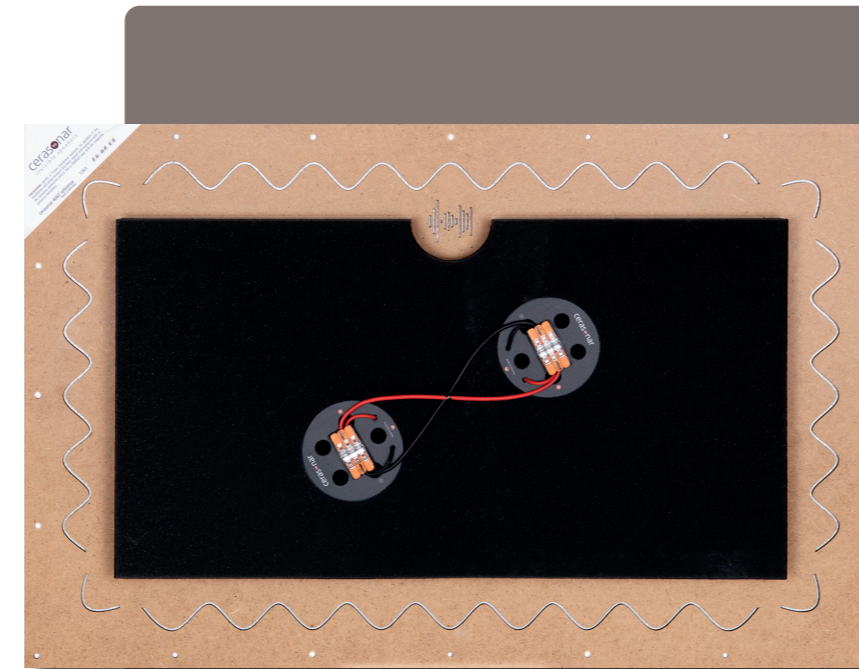

cerasonar 4062 reference

## Powerful and light - our top selling series

With our roots in the acoustic development, our goal was to create an invisible loudspeaker that thrives in home cinema and high level multiroom audio applications. The reference series starting with 1,2 kg, is lighter than other invisible speakers and is therefore very much loved by installers who place them overhead in the ceiling, even on larger projects.

To enhance its bass performance, we recommend the additional use of our cs-500dsp4 or cs-2000dsp4 amp or/and the combination with a cerasonar subwoofer or a third-party hidden subwoofer. Generally, pneumatic driven systems with conventional bass drivers make more excursion and vibration, therefore special attention must be paid so that cracks etc. in filler joints don't occur.

As an exception on the market, our reference series works as an exciter only invisible speaker which allows it to be installed carefree - special attention to reinforced substructure is with the reference series unnecessary.



cerasonar 6062 reference

## CAD details:

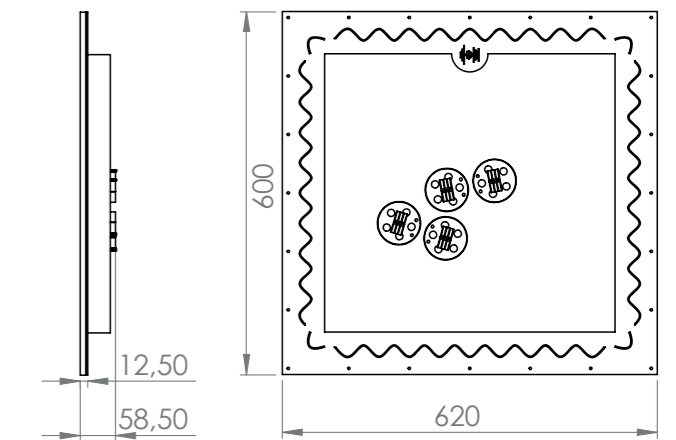
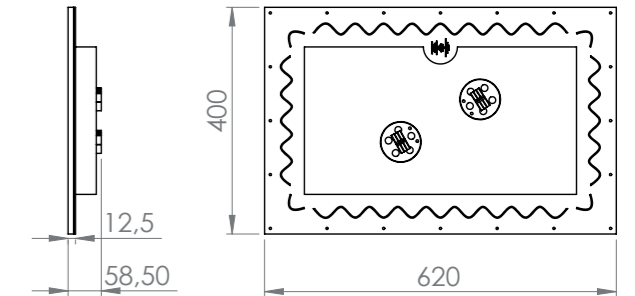

# cerasonar reference pro

reference pro - when perfection is key

	cerasonar 4062 reference pro	cerasonar 12030 reference pro
Power rating	75 w RMS (150 w max)	75 w RMS (150 w max)
Impedance	4 ohms	4 ohms
Frequency range	65 - 20.000 hz*	65 - 20.000 hz*
Frequency range with cs-500dsp4	55 - 20.000 hz*	55 - 20.000 hz*
max SPL	107 db	107 db
Dispersion range	180° x 180° h./v.	180° x 180° h./v.
Single stereo mode	no	no
for humid environments	no	no
Drywall	1- or 2- layered 12,5 mm plasterboard	1- or 2- layered 12,5 mm plasterboard
Installation cut out	35,0 x 57,0 cm	115,0 x 25,0 cm
Dimensions	40,0 x 62,0 x 5,8 cm	120,0 x 30,0 x 5,8 cm
Weight	1,4 kg	1,7 kg
Accessories	cerasonar protection unit pro 50w/100w (we recommend to use the cs-500dsp4) cerasonar cs-500dsp4 amp cerasonar cs-2000dsp4 amp cerasonar frame 4062 cerasonar backbox 4062	cerasonar protection unit pro 50w/100w (we recommend to use the cs-500dsp4) cerasonar cs-500dsp4 amp cerasonar cs-2000dsp4 amp cerasonar frame 12030

Scan the QR code with your telephone to show the cerasonar installation video



\* depending on installation situation

## reference pro - when perfection is key

The cerasonar reference pro is based on our top-selling reference series with enhanced maximum level performance and sound pressure curve. It is used when that „little bit more“ can make all the difference.

For a more precise high-frequency reproduction and higher power handling, the cerasonar reference pro series is equipped with an optimised exciter driver with a modified voice coil and a stronger neodymium magnet system.

The frequency response of this series is linearised by tuning with the cerasonar mcc system and a counterweight, resulting in a very balanced frequency response, with great advantages in the low frequency range.

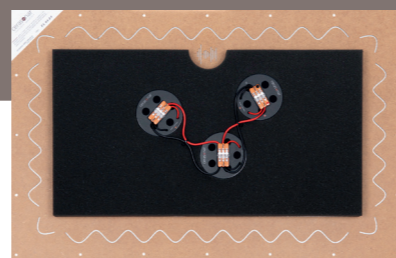

cerasonar 4062 reference pro

The cerasonar reference pro series consists of three different models. The best-selling size (400x620 mm) is of course also available as cerasonar 4062 reference pro. Due to its small size and light weight, it can be installed in ceilings as well as walls.

No invisible loudspeaker is as slim yet as powerful in home cinema as our 12030 reference pro. We have often been asked for a slim but powerful speaker to enable installation between TVs and furniture.

Best performance is achieved in combination with the cs-500dsp4 or cs-2000dsp4. The fullrange preset delivers deep and powerful bass performance - music enthusiasts will adore the performance of the extremely responsive exciter drivers. We offer a preset that delivers extremely high SPL levels as well - ideal for homecinema applications.

### Where flexibility knows no limits

Your project has a concrete or masonry installation where the load-bearing capacity must be kept to a minimum? In this case, the 12030 reference pro can also be installed vertically.

### CAD details:

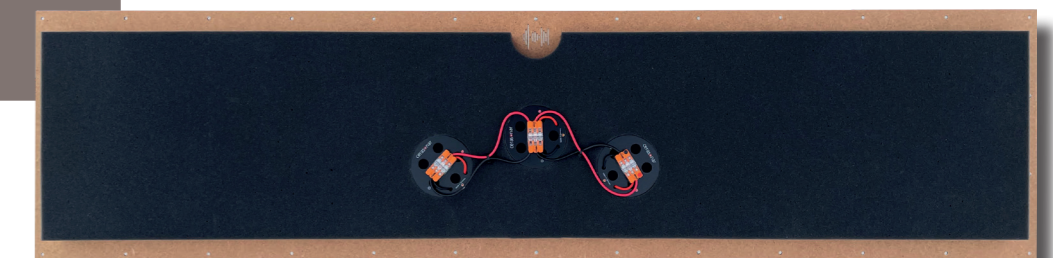
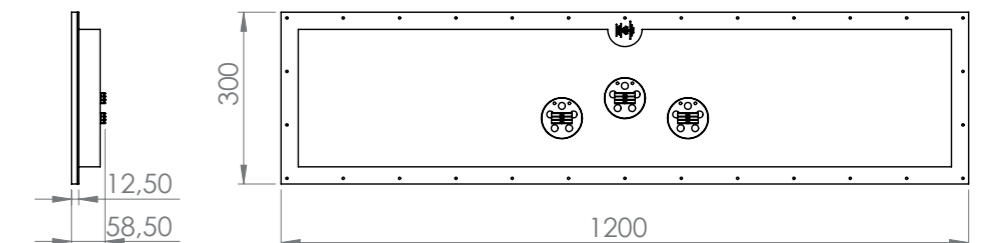
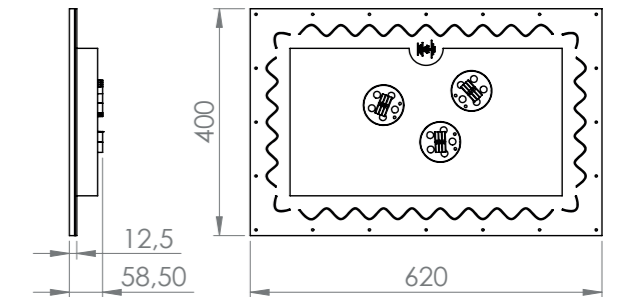

cerasonar 12030 reference pro

# cerasonar reference pro

most powerful exciter based loudspeaker on the market

## cerasonar 6062 reference pro

Power rating	150 w RMS (300 w max)
Impedance	8 ohms / 2x 4 ohms
Frequency range	65 - 20.000 hz*
Frequency range with cs-500dsp4	55 - 20.000 hz*
max SPL	110 db
Dispersion range	180° x 180° h./v.
Single stereo mode	yes
for humid environments	no
Drywall	1- or 2- layered 12,5 mm plasterboard
Installation cut out	55,0 x 57,0 cm
Dimensions	60,0 x 62,0 x 5,8 cm
Weight	2,5 kg

Accessories

- cerasonar protection unit pro 50w/100w (we recommend to use the cs-500dsp4)
- cerasonar cs-500dsp4 amp
- cerasonar cs-2000dsp4 amp
- cerasonar frame 6062
- cerasonar backbox 6062



Scan the QR code with your telephone to show the cerasonar installation video

\* depending on installation situation

## reference pro - *when perfection is key*

The cerasonar 6062 reference pro is the most powerful exciter based loudspeaker on the market. It is characterised by its high power handling, max. SPL and low weight. Music reproduction remains crystal clear and distortion-free even at the highest volume levels. Given these features, we particularly advise them for larger home cinemas or even large club rooms.

By using an additional subwoofer and our cerasonar amp with the specially developed preset, the speaker is relieved in the bass range, so that the full 150 / 300 watts in the low-mid and treble range provide extremely high SPL levels.

Through customer feedback, we learnt that a flawless substructure is not always guaranteed. With the most powerful exciter-based loudspeaker, we have developed a product that can develop its full audio performance even in challenging substructures.

Where other pneumatically driven systems with an additional bass speaker can often cause vibrations, especially in metal substructures, our series can guarantee trouble-free installation.

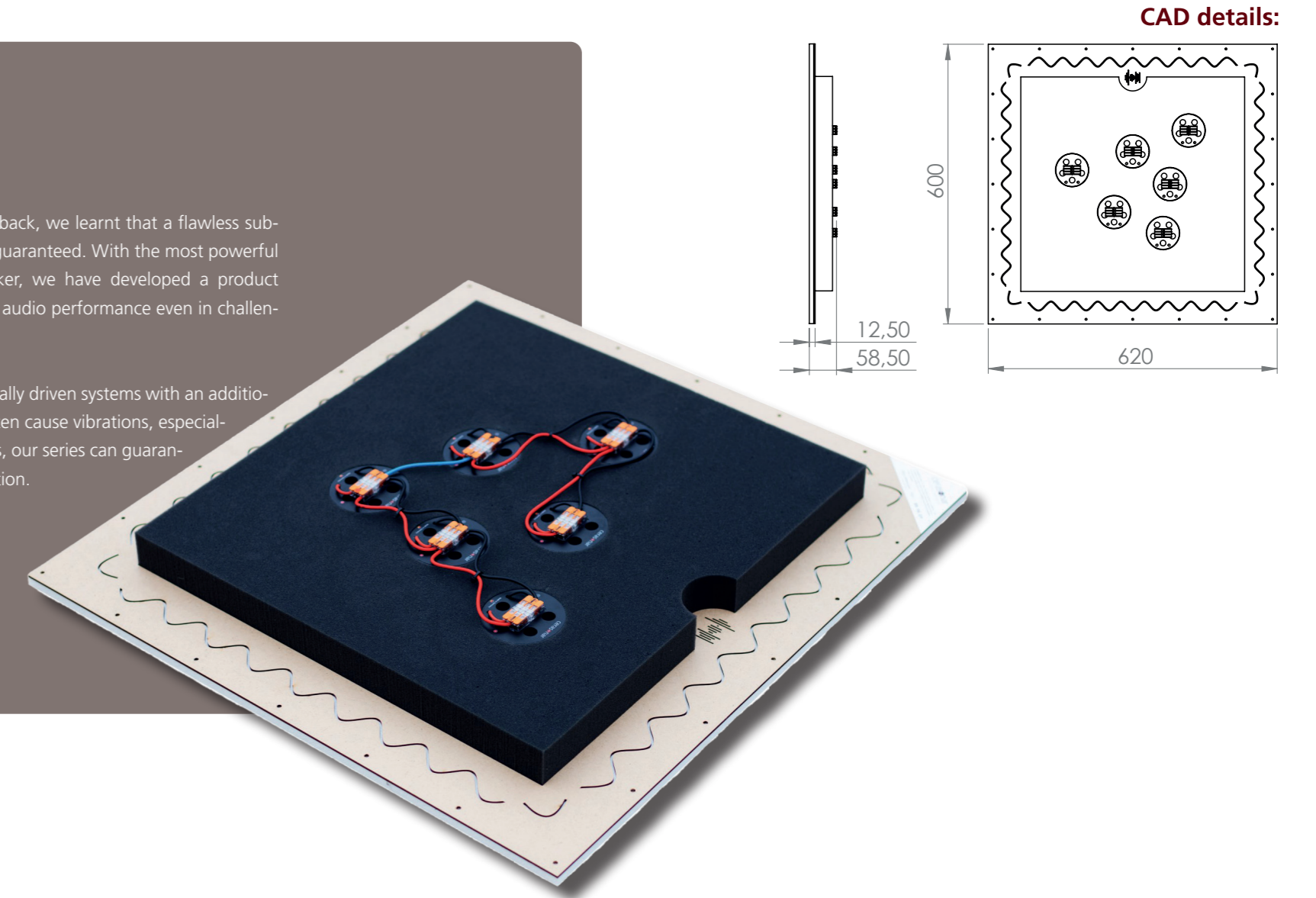



## cerasonar 9062 ultimate

Power rating	125 w RMS (250 w max)
Impedance	4 ohms
Frequency range	35 - 20.000 hz* / *2
Frequency range with cs-500dsp4	30 - 20.000 hz* / *2
max SPL	105 db
Dispersion range	180° x 180° h./v.
Single stereo mode	no
for humid environments	no
Drywall	1- or 2- layered 12,5 mm plasterboard
Installation cut out	84,5 x 56,5 cm*3
Dimensions	90,0 x 62,0 x 11,2 cm
Weight	9,5 kg
Accessories	cerasonar cs-500dsp4 amp cerasonar cs-2000dsp4 amp cerasonar frame 9062 cerasonar backbox 9062

Scan the QR code with your telephone to show the **cerasonar installation video**



\* depending on installation situation  
\*2 we recommend min. 100 litres installation volume!  
\*3 with backbox: 86,0 x 58,0

All cerasonar loudspeakers and subwoofers with conventional woofer drivers (except cerasonar architect sub) require a high-quality substructure to ensure the best performance possible.

We recommend the use of wooden studs. The wall or ceiling should be planked in two layers, the first of which is OSB 12-21 mm.

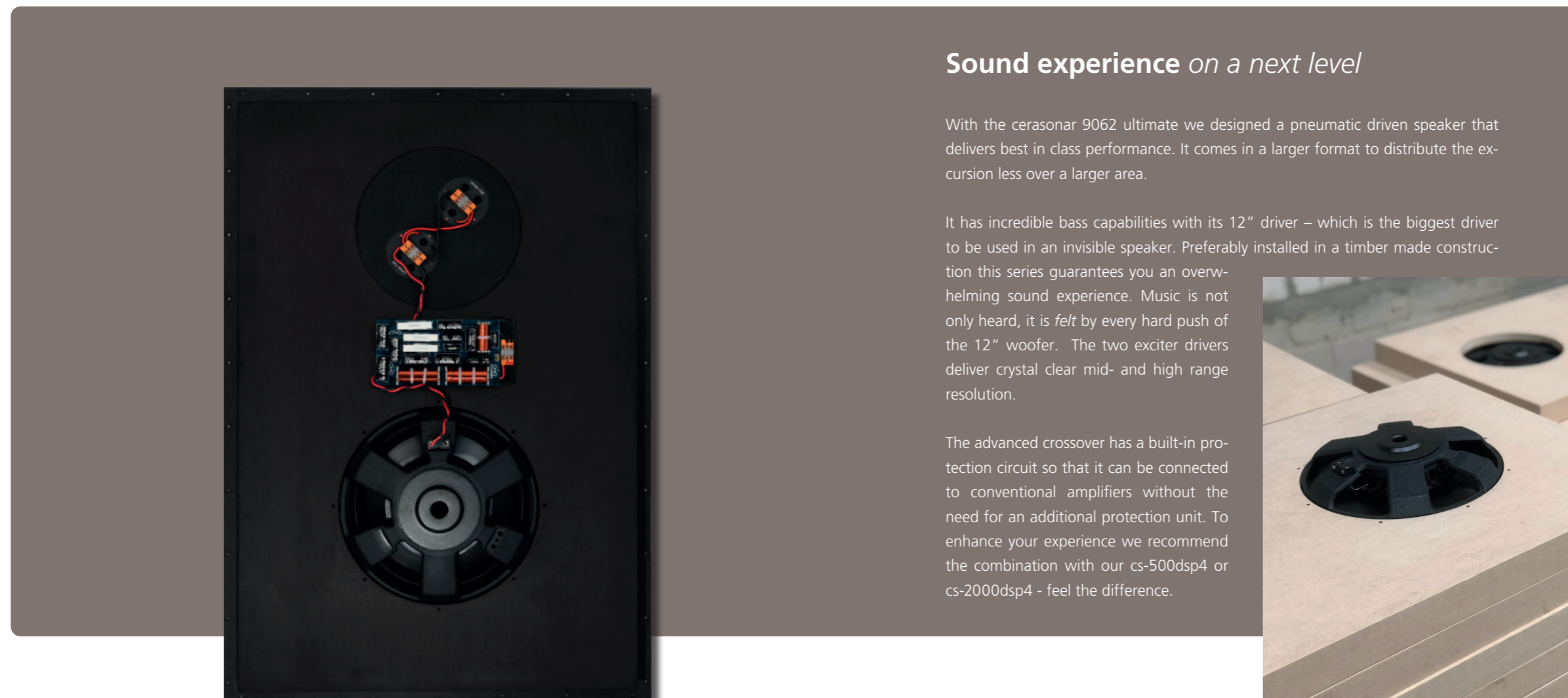

## Sound experience *on a next level*

With the cerasonar 9062 ultimate we designed a pneumatic driven speaker that delivers best in class performance. It comes in a larger format to distribute the excursion less over a larger area.

It has incredible bass capabilities with its 12" driver – which is the biggest driver to be used in an invisible speaker. Preferably installed in a timber made construction this series guarantees you an overwhelming sound experience. Music is not only heard, it is *felt* by every hard push of the 12" woofer. The two exciter drivers deliver crystal clear mid- and high range resolution.

The advanced crossover has a built-in protection circuit so that it can be connected to conventional amplifiers without the need for an additional protection unit. To enhance your experience we recommend the combination with our cs-500dsp4 or cs-2000dsp4 - feel the difference.



## CAD details:

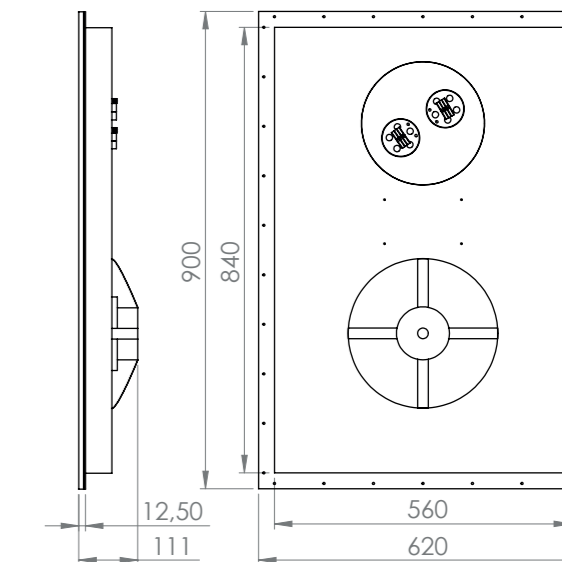

# cerasonar subwoofer

the perfect complement to our speakers



cerasonar 6062 sub

	cerasonar 6062 sub	cerasonar 10040 sub	cerasonar 13362 sub
Power rating	125 w RMS (250 w max)	150 w RMS (300 w max)	2x 250 w RMS (500 w max) or 1x 500 w RMS (1000 w max)
Impedance	4 ohms	4 ohms	2x 8 ohms or 1x 4 ohms
Frequency range	35 - 150 hz* / *2	35 - 150 hz*	25 - 150 hz*
Frequency range with cs-500dsp4	30 - 150 hz* / *2	30 - 150 hz*	20 - 150 hz*
max SPL	107 db	108 db	116 db
Dispersion range	hemispheric	hemispheric	hemispheric
Single stereo mode for humid environments	no	no	yes
Drywall	1- or 2- layered 12,5 mm plasterboard	1- or 2- layered 12,5 mm plasterboard	1- or 2- layered 12,5 mm plasterboard
Installation cut out	54,5 x 56,5 cm	94,5 x 34,5 cm	127,5 x 56,5 cm
Vent	no vent	1,0 x 30,4 cm	1,8 x 52,2 cm
Dimensions	60,0 x 62,0 x 11,2 cm	100,0 x 40,0 x 10,1 cm	133,3 x 62,0 x 13,8 cm
Weight	7,0 kg	10,0 kg	25,0 kg
Accessories	cerasonar cs-500dsp4 amp cerasonar frame 6062 cerasonar backbox 6062 sub	cerasonar cs-500dsp4 amp cerasonar frame 10040	cerasonar cs-500dsp4 amp cerasonar cs-2000dsp4 amp cerasonar frame 13362

Scan the QR code with your telephone to show the cerasonar installation video



\* depending on installation situation  
\*2 we recommend min. 100 litres installation volume

All cerasonar loudspeakers and subwoofers with conventional woofer drivers (except cerasonar architect sub) require a high-quality substructure to ensure the best performance possible.

We recommend the use of wooden studs. The wall or ceiling should be planked in two layers, the first of which is OSB 12-21 mm.

## The perfect complement to our speakers

The cerasonar subwoofers are the natural complement to our speakers. The cerasonar 6062 sub uses the same 12" woofer that is used in the 9062 ultimate ensuring a rich, precise sound reproduction and an incomparable bass quality.

The 10040 and 13362 subs have an integrated backbox that provides you with the advantage that extra internal volume is not necessary. The smaller of the two is the perfect fit for small to medium sized rooms whereas the huge 13362 sub with four long stroke 8" subs is your choice for a multi-sensational home cinema experience with a high-energy bass presentation.



cerasonar 10040 sub



cerasonar 13362 sub

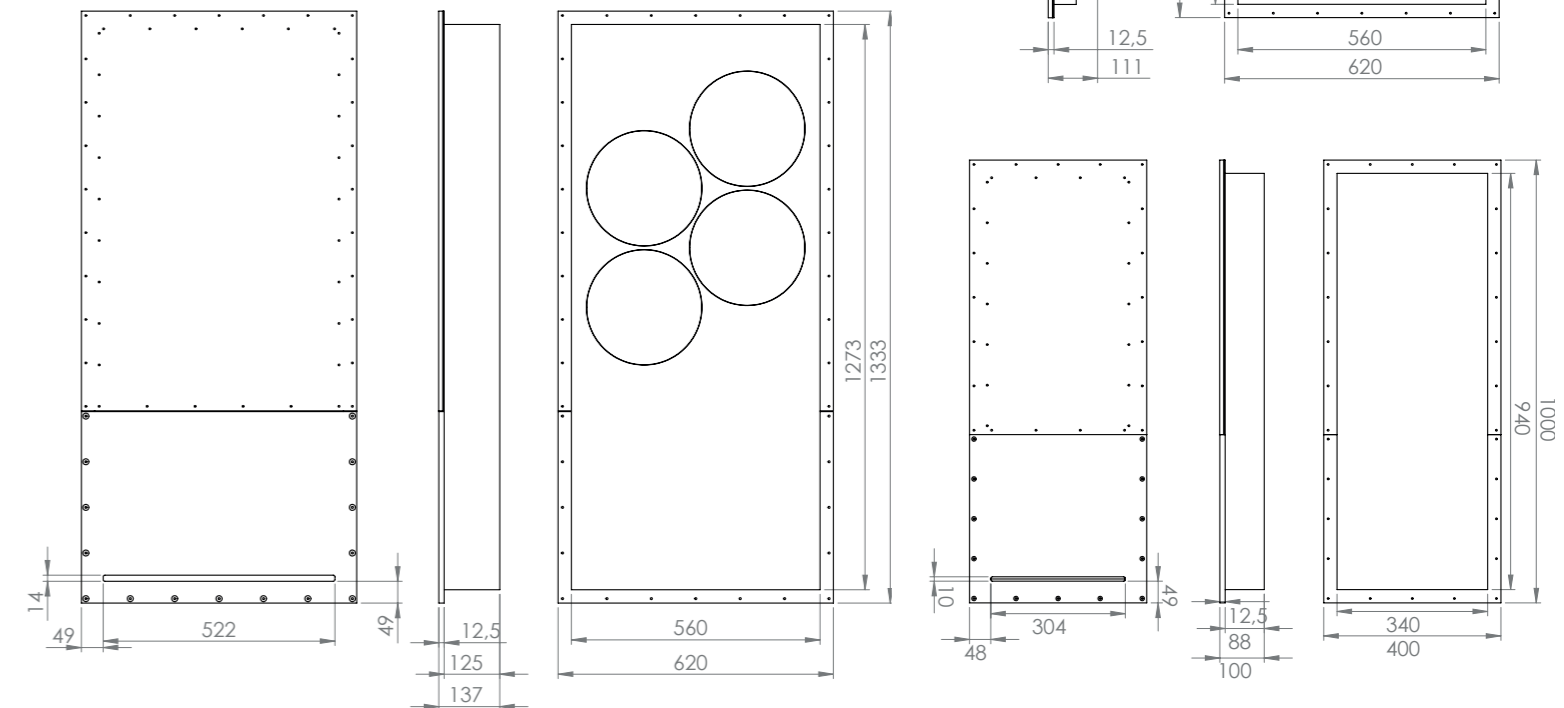

## cerasonar architect sub

Power rating	150 w RMS (300 w max)
Impedance	4 ohms
Frequency range	35 - 100 hz*
Frequency range with cs-500dsp4	30 - 100 hz*
max SPL	108 db
Dispersion range	hemispheric
Single stereo mode	no
for humid environments	no
Drywall	1- or 2- layered 12,5 mm plasterboard
Installation cut out	/
Vent	8,5 x 8,5 cm
Dimensions	35,0 x 27,5 x 20,0 cm (only housing, without parts)
Weight	8,5 kg
Accessories	cerasonar cs-500dsp4 amp cerasonar cs-2000dsp4 amp

1x subwoofer

1x flexible ventilation-pipe 80 mm (40 cm length)  
2x pipe clamps

Delivery content 1x bracket for vibration reduced mounting (wall and ceiling)

1x ventilation grille (black)  
1x adapter for drywall installation (single layer 12,5 mm)  
1x adapter for drywall installation (double layer 25,0 mm)

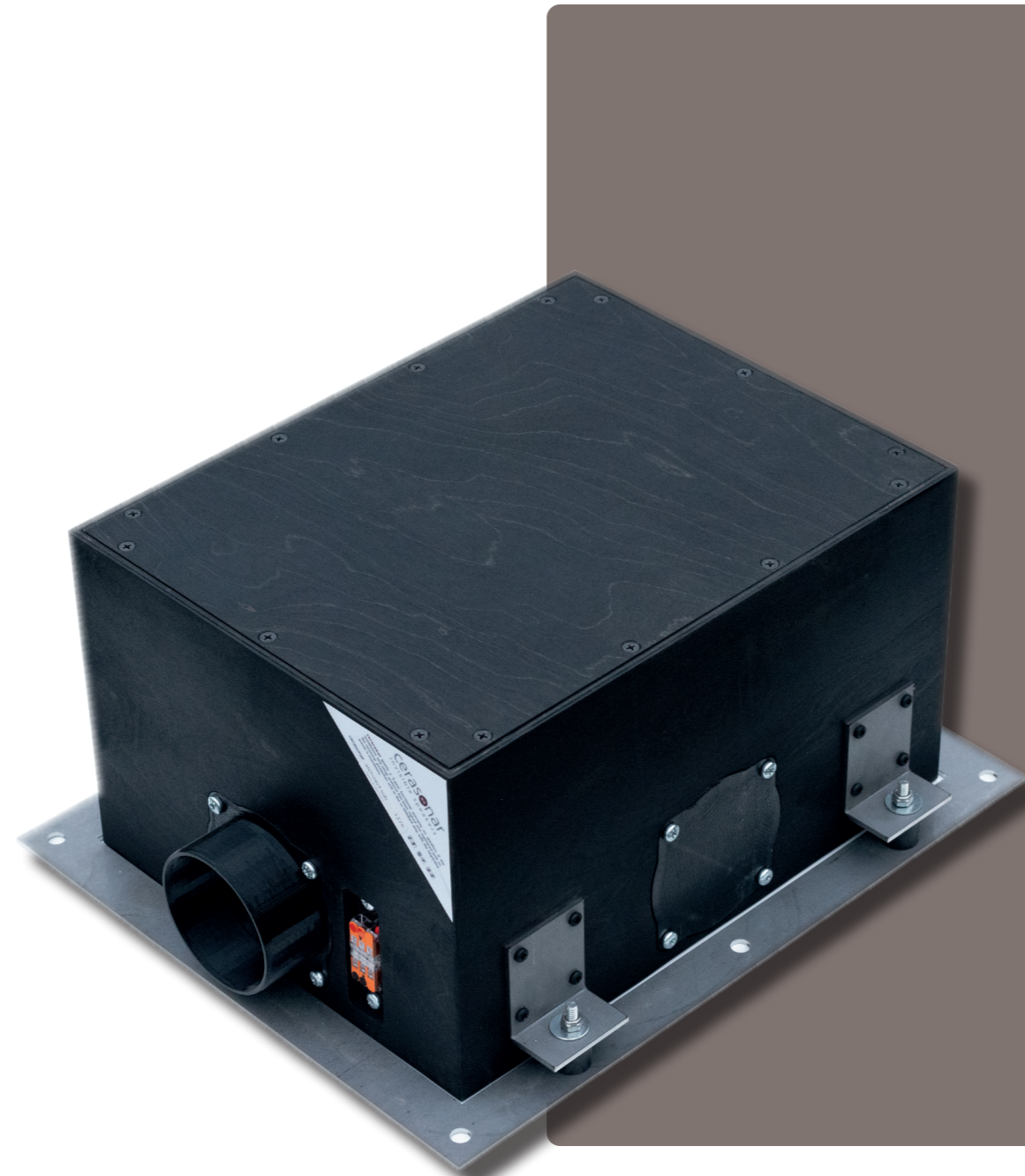

## Vibration free bass *in every room*

The cerasonar architect sub is the ideal bass support for all cerasonar speakers. It unfolds its ingenious potential when there is no space for an invisible subwoofer or no stable (and „rattle-free“) substructure. It can be installed in a drywall. The small powerhouse with 8“ drivers delivers an extra kick in multi-room music projects or home cinema applications.

### What makes our cerasonar architect sub so special?

Specially developed vibration dampers on the mounting bracket provide significant structure-borne sound and vibration reduction for wall and ceiling installations, making our cerasonar architect sub an ideal solution for multi-party homes or small rooms.

### Installation

For a quick and easy overhead installation, we have equipped our cerasonar architect sub with a light but above all very stable mounting bracket. First, the bracket including the vibration dampers is mounted on the ceiling, then the subwoofer is screwed and secured with four safety nuts.

The 40 cm long 80 mm ventilation pipe is made of high-quality rubber, which guarantees a small radius. Two openings are provided to ensure trouble-free installation. The opening that is not needed is closed with a blind plug.

To fit perfectly into modern interior design, the elegant and small (85 x 85 mm) air outlet has no frame and is thus flush with the wall or ceiling. It can be installed in drywall (1-layer or 2-layer). If a different colour of grille is desired, it can easily be adapted with a conventional paint spray.



Scan the QR code with your telephone to show the **cerasonar installation video**



\* depending on installation situation

**cerasonar cs-500dsp4**

Amplifier power output	4x 125w @ 4/8 ohms 2x 250 W @ 8 ohms (bridged) 2x 250w @ 70/100V
DSP	28-/56-BIT, 50 MIPS High pass filter 3x DSP filters per channel 4x4 Input matrix Power limitation
Network	10/100M LAN
Input voltage	115 V or 230 V (automatically)
Total dimensions	215 x 44 x 240 mm
Weight	2 kg
Delivery content	Power cable Input adapter Phoenix to Cinch Adapter for 19" rack mounting (1x amps in 1U) Adapter for 19" rack mounting (2x amps in 1U)

Scan the QR code with your telephone to show the installation of the cerasonar cs-500dsp4 rack ears



**Most space saving amp -  
up to 8 powerful channels in 1U**

In order to serve you with the smartest sound experience possible, we developed the cerasonar cs-500dsp4 DSP amplifier that comes with predefined presets for each cerasonar speaker and subwoofer. The use of an extra cerasonar protection unit is not required. This amplifier is your game changer in high-demanding multi-room-projects that request the finest sound quality possible.

A digital power supply provides a stable voltage supply and four autonomous amplifier chips from International Rectifier ensure flawless as well as distortion-free amplification, even at maximum load. Even at high temperatures, the cs-500dsp4 works reliably due to a built-in fan with intelligent temperature-dependent fan speed. In normal operation, the fan remains switched off, which means that no disturbing fan noise is caused and it can also be used as a stand-alone device.

The four power amplifiers deliver 125 watts per channel into 4 or 8 ohms and can be bridged to 250 watts into 8 ohms if required. In bridge mode the 70V / 100V mode is also supported. For an easier installation we offer additional audio transformers for our speakers and subwoofers.

Due to its compact dimensions, the amplifier requires little space in the server cabinet. Depending on requirements, one or two amplifiers fit next to each other in 1U, the adapter plates are of course included in the delivery.

The cs-500dsp4 can be easily and quickly connected to the most common Smart Home systems. This makes it the ideal partner for multi-room audio projects that can be controlled by the system pioneer control4, for example.

As professional installations 100v systems are a popular choice, the cs-500dsp4 provide you with 100v (or 70v) mode as well.

With the additional 100v transformers for our speakers you only need to route one cable and connect all the speakers in series. This saves you a lot of cabling and amp channels.



## cerasonar cs-2000dsp4

Amplifier power output	4x 500w @ 4 Ohm / 4x 300w @ 8 ohms 2x 1000 W @ 8 ohms (bridged) 2x 1000w @ 70/100V
Input	Analogue (Phoenix and XLR) Dante Pink noise, white noise Sine wave (20-22.000 Hz)
Output	Analogue passthrough (Phoenix)
DSP	DSP Presets Input EQ (31 filters per channel) Output EQ (10 filters per channel) 4x4 Input matrix Delay Compressor Power limitation and many more...
Control	10/100M LAN, USB, RS485, RS232
Input voltage	230 V
Total dimensions	483 x 300 x 44.5 mm
Weight	4,2 kg
Delivery content	Power cable Phoenix input block 12V trigger adapter

Scan the QR code with your telephone to show a video of the software of the cerasonar cs-2000dsp4



## Powerful DSP amp - with Dante support

The cs-2000dsp4 is the logical continuation of the cs-500dsp4. It is used when even more power and room calibration is necessary. It provides you with incredible flexibility in challenging installation situations, as it not only comes with 31 input and 10 output filters per channel, but also has a delay and compressor function, among other things. Provided that the preset for the respective loudspeaker has been selected, a protection unit is no longer required.

The amplifier is controlled via USB or LAN (several units can be controlled simultaneously). In both cases, no additional device drivers are necessary. Basic settings can be made via the LCD display, there is also password protection to prevent the amplifier from unauthorised access. Analogue input sources (balanced and unbalanced) can be connected via XLR (adapter cable RCA to XLR available on request) or Phoenix terminal. The latter ensure that the signal can also be routed to another amplifier. It was important to us that the cs-2000dsp4 is fully Dante-compatible, so that digital sources can be connected easily.

For a proper installation of the cerasonar speakers, a prior sound check is indispensable. In order to check for possible vibration noises (e.g. loose substructure screw connection), the software contains a tone generator (sine tone) which can be used to smoothly adjust the desired frequency. In addition, a „pink noise“ and „white noise“ can be output. This means that the frequency curve can be checked without connecting an additional measuring system - only a smartphone is necessary.\*  
-> Ideal to determine the correct phase or delay, or to make DSP corrections!

The power of the cs-2000dsp4 is 4x 500 watts into 4 ohms or 2x 1000 watts into 8 ohms or 70/100V (bridged). Due to the high power output, the amplifier is ideal for driving larger 70/100V systems or for operation with our powerful subwoofers or speakers.

There are two LAN ports; for larger projects, the amplifiers can be connected to each other so that only one LAN port is required for connection.

Basic functions of the amplifier can be controlled via the RS232 or RS485. The supplied adapter also allows ON/OFF control of the amplifier via the GPIO port.

\*The measurement result depends on the quality of the built-in microphone. A calibrated, external one is recommended.

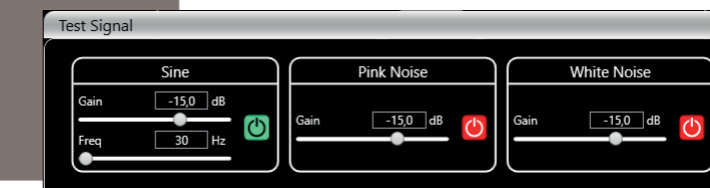
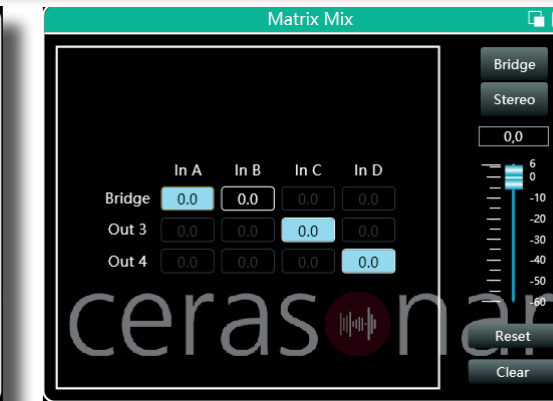
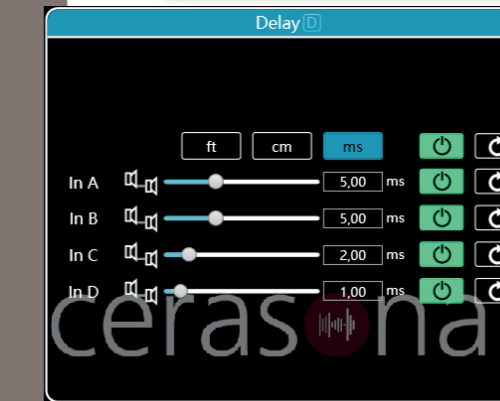
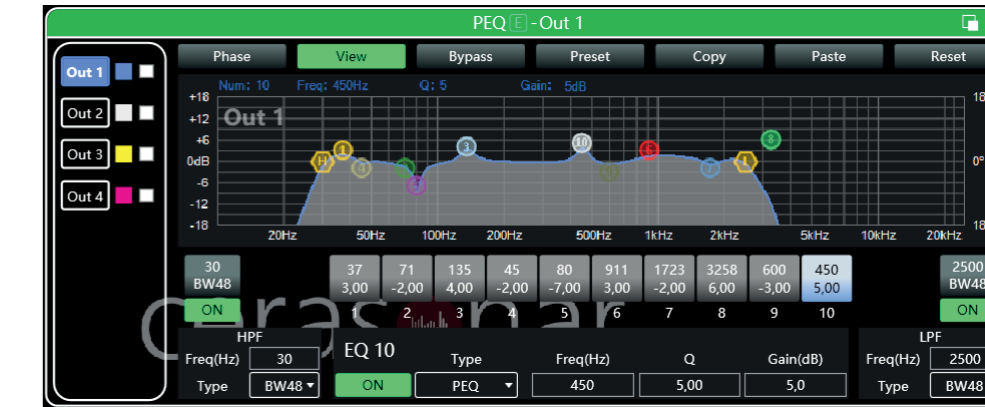



colour: anthrazite  
top surface: rough

# cerasonar concrete

outdoor speakers that blend in with the aesthetics of your garden

## cerasonar concrete speakers

The cerasonar concrete series blends harmoniously into any landscape. Available as full-range speaker and subwoofer, they deliver superior sound quality with 360° dispersion into any garden. Available in three different colours, with each enclosure being unique.

Operation is exclusively with cerasonar DSP amplifiers, whereby each speaker driver is individually controlled and digitally equalised. The amplifiers are pre-configured for easy configuration.

For high volumes and very powerful bass levels, we recommend the additional use of the cerasonar concrete sub.

	cerasonar concrete one	cerasonar concrete sub
Power rating	2x 125 w RMS (2x 250 w max)	250 w RMS (500 w max)
Frequency range	40 - 20.000 hz*	25 - 250 hz*
max SPL	110 db	110 db
Dispersion range	360°	360°
Single stereo mode	yes	no
Weight	35 kg	35 kg
Dimensions	39 x 41.5 x 39 cm	39 x 41.5 x 39 cm
Required cable	1x 4 wires or 2x 2 wires	1x 2 wires
Required amp	cs-500dsp4 (2 channels) or cs-2000dsp4 (2 channels)	cs-500dsp4 (2 channels, bridged) or cs-2000dsp4 (2 channels, bridged)
Preset for amp	available and preloaded w/ amp	available and preloaded w/ amp
Included accessories	1x Neutrik speakON NL4FX	1x Neutrik speakON NL4FX
Application	indoor / outdoor	indoor / outdoor

With these unique pieces, colour deviations are part of the vivid appearance of the concrete. Ensure that there is a firm base when placing the unit in the garden. The cerasonar concrete products are available in grey (standard), anthracite and white. The top surface is available smooth (standard) or rough.



## cerasonar speaker installation cable 2x 2,08 mm<sup>2</sup>

Cross-section	2x 2,08 mm <sup>2</sup>
Conductor structure	43 x 0.25 mm CU blank (UNE 21-011)
Insulation of the conductors	Ø 3,00 mm (PTC UNE 21-031)
External insulation	Ø 8,00 mm (PTC UNE 21-031)
Colour	White
Weight per cable reel	37 kg (cable reel including)
Packaging	300 metres on cable reel (made of wood)

## cerasonar speaker installation cable 4x 2,08 mm<sup>2</sup>

Cross-section	4x 2,08 mm <sup>2</sup>
Conductor structure	43 x 0.25 mm CU blank (UNE 21-011)
Insulation of the conductors	Ø 3,00 mm (PTC UNE 21-031)
External insulation	Ø 9,00 mm (PTC UNE 21-031)
Colour	White
Weight per cable reel	54 kg (cable reel including)
Packaging	300 metres on cable reel (made of wood)

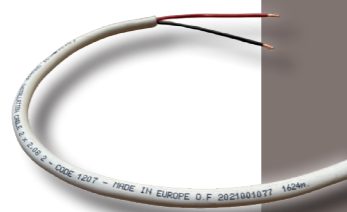

## Quality cable - saving you time and energy

During the development process, it was particularly important to us that we could offer you a speaker cable that is very easy to work with, but still remains securely protected by a thick and tough jacket so that it cannot be damaged even by sharp-edged substructure profiles.

The speaker cable is available as 2 or 4-core and the conductors are made of high-purity copper. The cable cross-section is 2.08 mm<sup>2</sup> or 14 AWG. The 4-core can be used for single stereo applications or combined into a high performance 2x 4.16 mm<sup>2</sup> or 11 AWG cable for very long cable lengths to avoid power loss.

The cable fits easily into any cerasonar speaker terminal and, of course, with a suitable cable lug, into the Phoenix connectors of the cerasonar cs-500dsp4. For use with the cs-2000dsp4 we recommend the use of banana plugs.

Smart metre markings providing you with the advantage that you can cut the cable into length without remeasuring. Of course, it can also be stripped easily even if it has been stored at low temperatures for a longer period of time. Coming with a useful length of 300m, even two people can transport our cable drums easily.

**Further we are proud that our cables are manufactured in Europe and do not require a long and CO2-heavy transport route.**

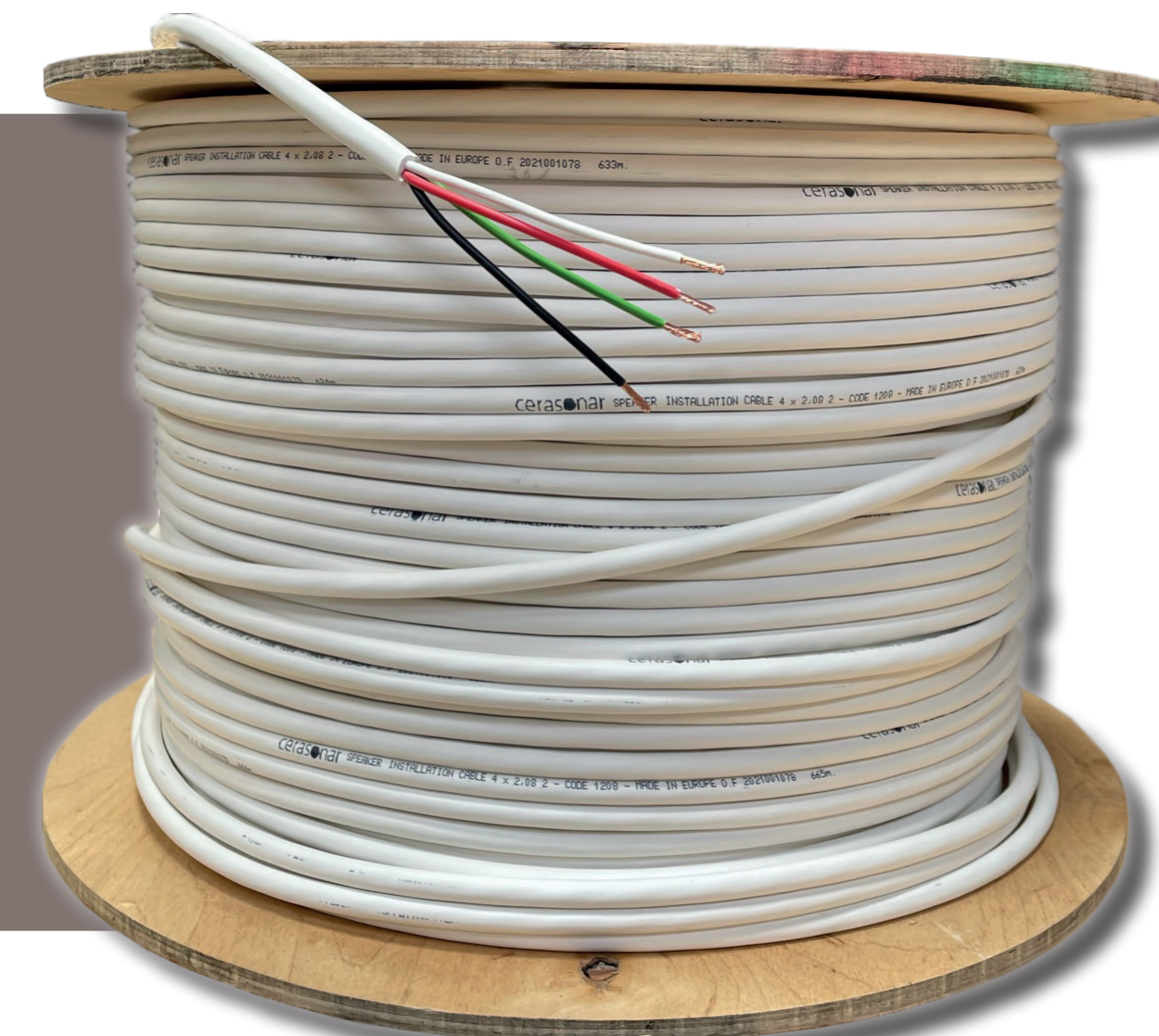

# cerasonar protection units

made for the fit and reference series

## protection unit pro 25w

Size	20,0 x 9,1 x 4,9 cm
Jumper settings	F1 + F4
Delivery content	protection unit pro 25w + phoenix adapter

Suitable for cerasonar 4062 architect  
cerasonar 4062 reference single stereo  
(2 units per speaker)

## protection unit pro 50/100w

Size	20,0 x 9,1 x 4,9 cm
Jumper settings	F3 + F6
Delivery content	protection unit pro 50/100w + phoenix adapter

Suitable for cerasonar 4062 reference  
cerasonar 4062 reference pro  
cerasonar 6062 reference  
cerasonar 6062 reference single stereo  
(2 units per speaker)



## Protection Unit Pro - made for the reference series

This protection unit pro is also an extended overload protection which also reacts to fast impulses. With this protective circuit, we grant a 5-year guarantee on our cerasonar series. As a German manufacturer, we comply with the VOB guarantee for drywall construction.

## Protection Unit - made for the fit series

This simplified protection unit can be used with cerasonar 1520 fit and 2525 fit. With this protective circuit we offer a 5 year warranty on our cerasonar series. As a German manufacturer, we fulfil the VOB guarantee for drywalls.

The protection unit is not suitable for use with an AV receiver, as the peak power of the AV receiver may not be detected by the sluggish protection circuit. In this case, we recommend using the protection unit pro or our cerasonar amplifiers.



## protection unit 25w

Size	20,0 x 9,1 x 4,9 cm
Jumper settings	F1 + F4
Delivery content	protection unit 25w + 2x WAGO 221

Suitable for cerasonar 1520 fit  
cerasonar 2525 fit single stereo  
(2 units per speaker)

## protection unit 50w

Size	20,0 x 9,1 x 4,9 cm
Jumper settings	F3 + F6
Delivery content	protection unit 50w + 2x WAGO 221

Suitable for cerasonar 2525 fit

The use of cerasonar protection units is no longer necessary with the cs-500dsp4 or cs-2000dsp4 when the appropriate preset for the respective speaker/sub has been selected.



	backbox available	installation cut out	depth excl. speaker
1520 fit	no		
2525 fit	no		
4062 architect	no		
4062 reference	yes	34,0 x 56,0 cm	9,9 cm
6062 reference	yes	54,0 x 56,0 cm	9,9 cm
4062 reference pro	yes	34,0 x 56,0 cm	9,9 cm
9062 ultimate	yes	85,7 x 57,7 cm	12,5 cm
6062 sub	yes	55,7 x 57,7 cm	12,5 cm
10040 sub	no*		
13362 sub	no*		

\*sub construction includes backbox as standard

END OF LIFE - STOCK AVAILABLE  
please use the cerasonar frame for new projects

## Backbox - reduce noise emissions

The backbox, which is mounted on the back of the respective cerasonar panel, serves to reduce noise emissions in neighbouring rooms.

The rear sound is decelerated by a sophisticated damping system and compression effects reduced. It is screwed to the back of the speaker panel.

To reduce the installation costs we already pre-mount the backboxes to the products. Therefore the products can be simply taken out of the carton and installed - with no further assembling tasks needed.

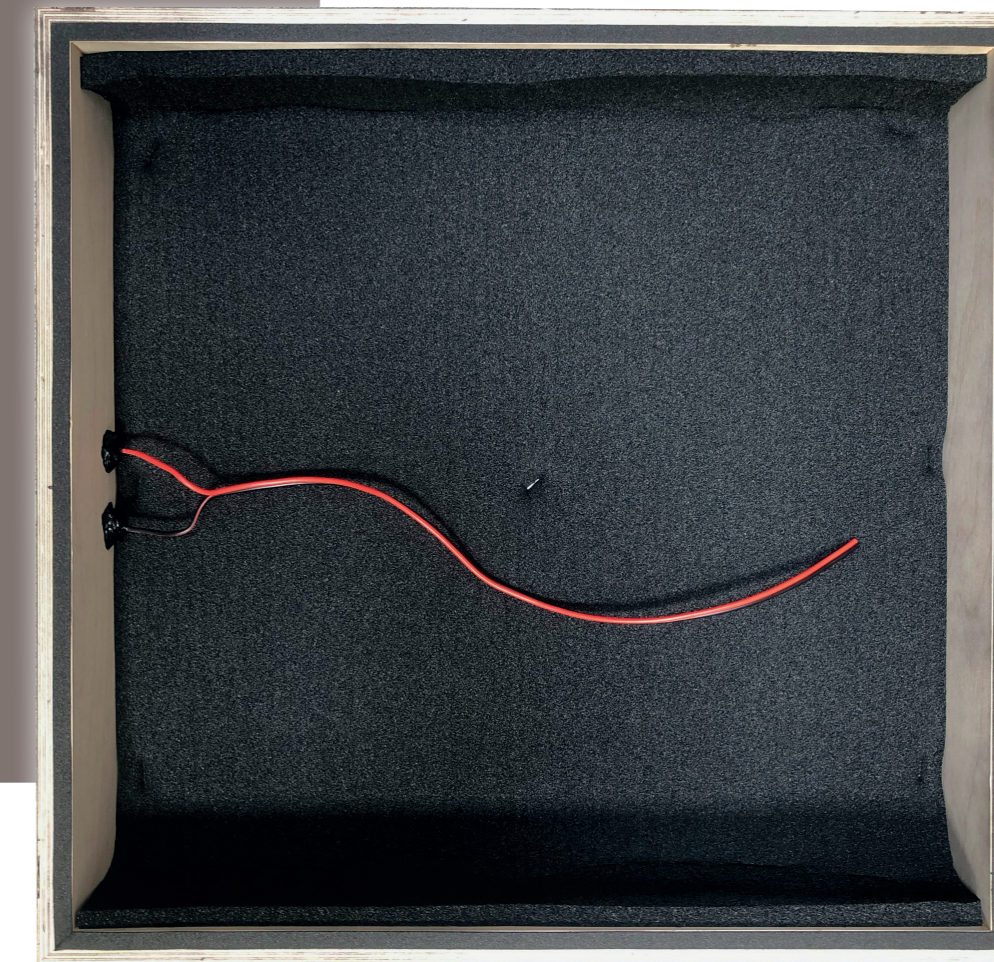

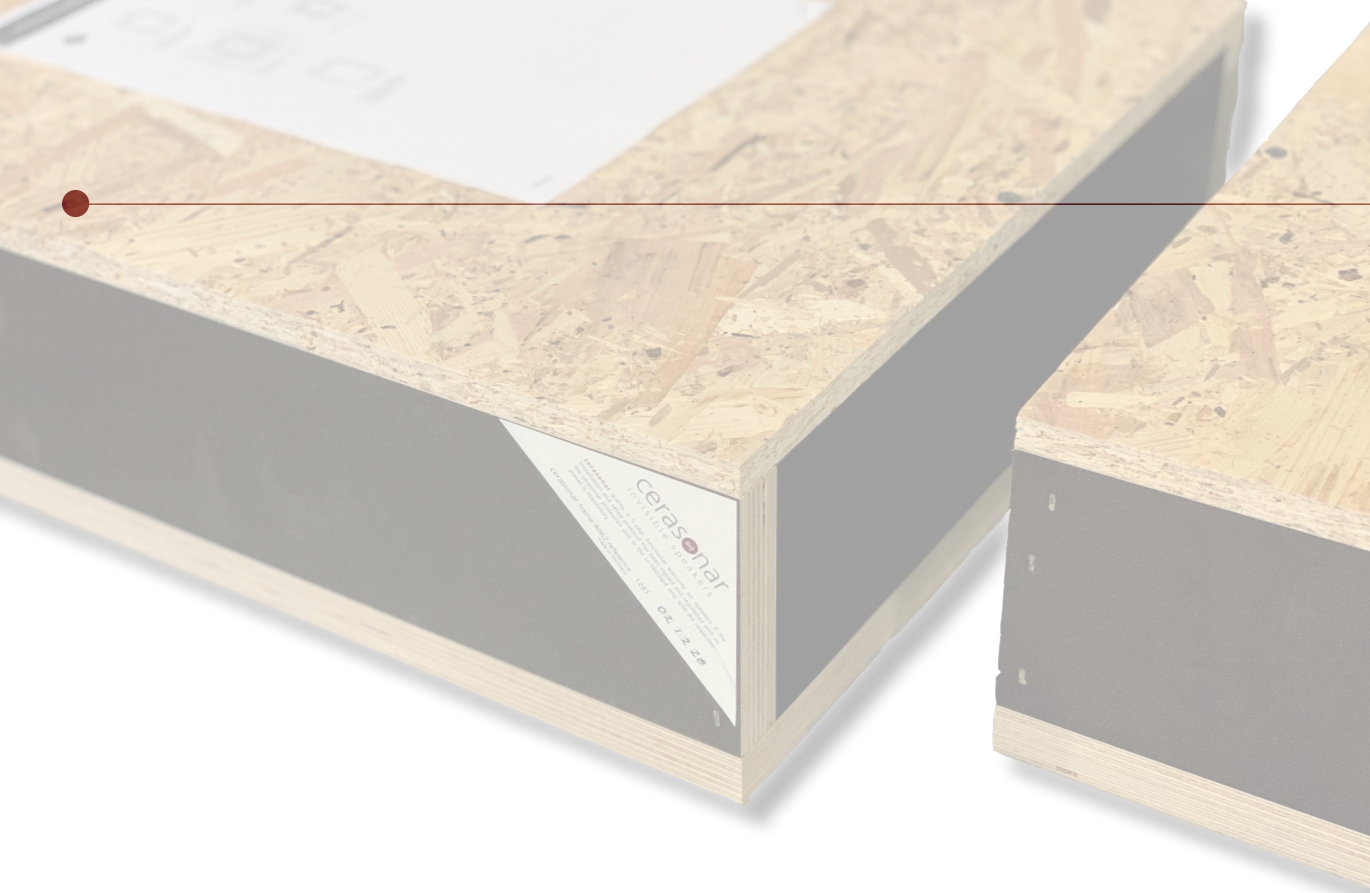

# cerasonar installation frame

for masonry or in-situ concrete installation



highly quality sound damping material



## Installation frames - for masonry, in-situ concrete and backbox

Our cerasonar frames can be used as a box for masonry installation, for in-situ concrete or also as a backbox for sound reduction in dry construction. The rear sound is thereby slowed down by a sophisticated damping system and compression effects are reduced. They are made of high-quality plywood and are supplied as closed boxes with a blind front panel, which is removed after installation and replaced by the actual loudspeaker or subwoofer.

### Masonry installation:

Using the two wooden slats supplied, the frame is inserted into a previously created wall niche and to be aligned flush.

### In-situ concrete:

The frame can also be used to mount cerasonar speakers in in-situ concrete walls or ceilings.

### Backbox:

In drywall construction, the frame serves to reduce noise emissions in neighbouring rooms. The rear sound is decelerated by a sophisticated damping system and compression effects reduced. The frame is attached to the substructure (the substructure should be mounted in a floating manner to minimise the transmission of structure-borne sound), the blanking plate must be flush with the plasterboard surface and serves as protection during the dry construction work. As soon as the installation of the speakers is to take place, the blind plate is removed and the speaker is inserted.

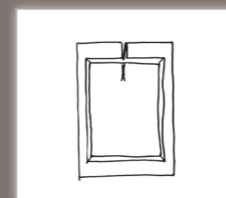

Create recess and feed loudspeaker cable

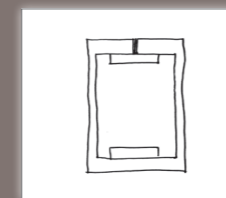

Inserting and aligning the installation frame

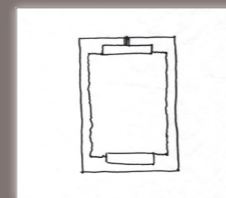

Fix with 2k expansion foam, e.g. 2K-Ponal Rapido PNR10

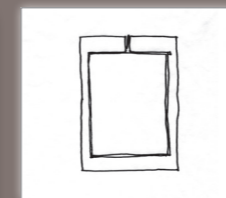

Remove wooden slats and blanking plate

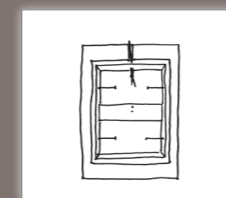

Dowel frame (optional)

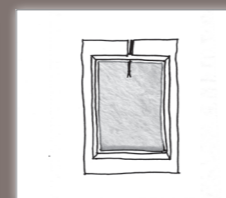

Fill cavity with mineral wool

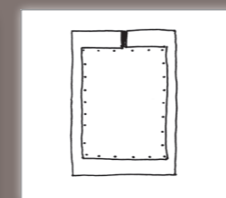

From here the installation instructions of the specific models follow

	frame 4062 architect*	frame 1520	frame 2525	frame 4062
Size	TBD	40,2 x 62,2 x 12 cm	40,2 x 62,2 x 12 cm	40,2 x 62,2 x 12 cm
Installation cut out	TBD	42,0 x 64,0 x 14 cm	42,0 x 64,0 x 14 cm	42,0 x 64,0 x 14 cm
Weight	TBD	2,5 kg	2,5 kg	2,5 kg
Delivery content	installation frame incl. damping material and wooden slats			

	frame 6062	frame 9062	frame 10040	frame 13362
Size*	60,2 x 62,2 x 12 cm	90,2 x 62,2 x 12 cm	100,2 x 40,2 x 12 cm	133,5 x 62,2 x 14,5 cm
Installation cut out*	62,0 x 64,0 x 14 cm	92,0 x 64,0 x 14 cm	102,0 x 42 x 14 cm	135,5 x 64 x 16,5 cm
Weight	3,7 kg	5,5 kg	4,0 kg	8,2 kg
Delivery content	installation frame incl. damping material and wooden slats			

\*frame 4062 architect only for masonry installations

# cerasonar placeholder

placeholder and template - easier installation

## Placeholder and template - easier installation

The cerasonar placeholder is ideal for new buildings where the position of the loudspeaker should be specified prior to installation. The placeholders are slightly larger, so that the installation of the loudspeakers runs smoothly.

	template available	placeholder available	size
1520 fit	yes	no	yes
2525 fit	yes	no	yes
4062 architect	no	yes	402 x 622 mm
4062 reference	no	yes	402 x 622 mm
6062 reference	no	yes	602 x 622 mm
4062 reference pro			402 x 622 mm
9062 ultimate	no	yes	902 x 622 mm
6062 sub	no	yes	602 x 622 mm
10040 sub	no	yes	1002 x 402 mm
13362 sub	no	yes	829 x 622 mm + 506 x 622 mm



## Transformers - to save cable length and amp channels

In large projects, the use of 100v audio technology is a popular choice. This can save a lot of cables and amp channels.

To prepare our speakers for this particular use, we recommend the installation of transformers nearby every speaker and to combine them with the cs-500dsp4 and cs-2000dsp4 amp to drive the transformers / speakers.

Make sure, that the transformers are well installed so that the speaker can not pass on audible noises. The delivery content includes not only the transformer but wago 221 connecting clamps as well as shrink sleeves providing you with extra security and protection to allow a fast and clean installation.

# cerasonar trafo

transformers - to save cable length and amp channels

### transformator 20w

Primary (amp)	100v
Secondary (speaker)	16Ω, 8Ω and 4Ω
Power settings	20w, 15w, 10w, 5w, 2,5w
Delivery content	transformer 100 v - 20w, wago 221 connecting clamp, shrink sleeves
Suitable speaker*	cerasonar 1520 fit
Suitable amp	cerasonar cs-500dsp4 or universal 100v amp



### transformator 50w

Primary (amp)	100v
Secondary (speaker)	16Ω, 8Ω and 4Ω
Power settings	50w, 37,5w, 25w, 12,5w, 6,25w
Delivery content	transformer 100 v - 50w, wago 221 connecting clamp, shrink sleeves
Suitable speaker*	cerasonar 2525 fit cerasonar 4062 architect cerasonar 4062 reference
Suitable amp	cerasonar cs-500dsp4 or universal 100v amp

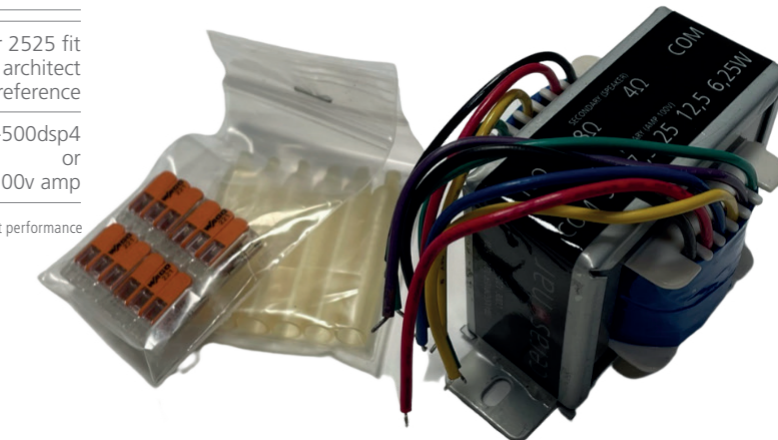

\*recommendation for best performance

# cerasonar installation process

how to install the fit series

# cerasonar installation process

how to install the architect, reference, ultimate and sub series

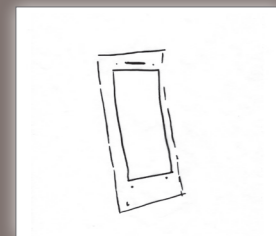

Check the construction for vibration noise, make sure the cavity has proper insulation. Attach the template on the wall or ceiling with tape

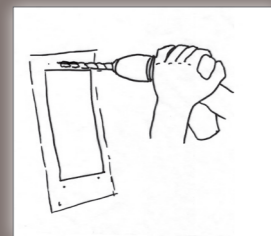

Drill four holes, these are intended for easy installation later. Drill size: 4 mm

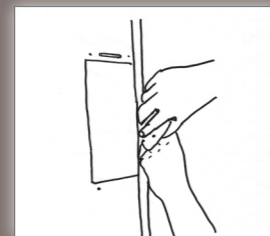

Mark the contours with a knife



Cut out the marked contours with an appropriate tool



Smooth the edges and cut them by 45° furthermore moisten the edges for better joint with the filler



Strip the wire by 10 mm. Connect the speaker cable to the speaker, be aware of the polarity

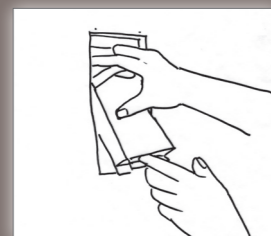

Insert the speaker, make sure there is no strain between the underlying insulation and speaker



Use the delivered screws and tighten them carefully  
**ATTENTION:** Test the speaker  
Remove the installation strip

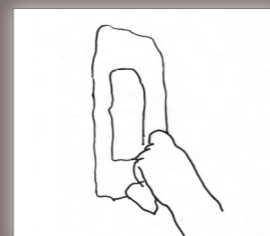

Optionally mesh tape in the plastering process. We recommend to use a flexible filler, e.g. Knauf Uniflott or Ardex 828



Up to 2mm of plaster can be applied. Before using the speaker, let the plaster dry off. More information in the FAQ



Check the construction for vibration noise, make sure the cavity has proper insulation. Prepare the wall or ceiling to fit in the speaker



Strip the wire by 10 mm



Connect the speaker cable to the speaker, be aware of the polarity

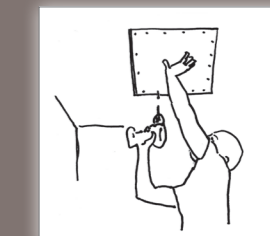

Insert the speaker, make sure there is no strain between the underlying insulation and speaker. Screw through all pre-drilled holes. The heads of the screws should penetrate about 1 mm into the panel material

**ATTENTION:** Test the speaker!



Fill in plaster, we recommend to use a flexible filler, e.g. Knauf Uniflott or Ardex 828



Use mesh tape in the plastering process (optional for architect and reference series)

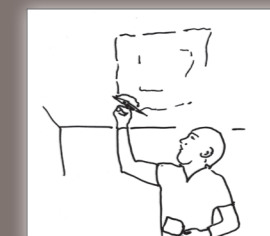

Up to 2mm of plaster can be applied, thus, Q3 and Q4 wall / ceiling quality levels are easily possible

**ATTENTION:** Before using the speaker, let the plaster dry off

More information about the installation process in our FAQ section

# cerasonar amp

recommended settings for cs-500dsp4

without  
added subwoofer

	bass performance	treble performance	high pass filter	low pass filter	limiter (cs-500dsp4)	impedance (cs-500dsp4)	eq filter 1 (cs-500dsp4)	eq filter 2 (cs-500dsp4)	eq filter 3 (cs-500dsp4)
1520 fit	★★	★	105 hz	none	- 7 db	8 ohms	treble 10000 hz, 5 db, q: 0.7	hpf 105 hz, 0 db, q: 1.5	peak 200 hz, - 5 db, q: 1.0
2525 fit *1	★★	★★	105 hz	none	- 4 db	4 ohms	treble 10000 hz, 5 db, q: 0.7	hpf 105 hz, 0 db, q: 1.5	peak 200 hz, - 5 db, q: 1.0
4062 architect	★	★★★★★	105 hz	none	- 7 db	4 ohms	none	hpf 105 hz, 0 db, q: 0.7	none
4062 reference *1	★★★	★★★★	70 hz	none	- 8 db	4 ohms	treble 12500 hz, 3 db, q: 1.0	hpf 70 hz, 0 db, q: 1.5	peak 8750 hz, - 5 db, q: 5.0
6062 reference *1	★★★★	★★★★	45 hz	none	- 9 db	8 ohms	treble 12500 hz, 3 db, q: 1.0	hpf 70 hz, 0 db, q: 1.5	peak 8750 hz, - 5 db, q: 5.0
4062 reference pro	★★★★	★★★★	70 hz	none	- 6 db	4 ohms	treble 12500 hz, 3 db, q: 1.0	hpf 70 hz, 0 db, q: 1.5	peak 8750 hz, - 5 db, q: 5.0
6062 reference pro *1	★★★★	★★★★	45 hz	none	- 7 db	8 ohms	treble 12500 hz, 3 db, q: 1.0	hpf 70 hz, 0 db, q: 1.5	peak 8750 hz, - 5 db, q: 5.0
12030 reference pro	★★★★	★★★★	70 hz	none	- 6 db	4 ohms	treble 12500 hz, 3 db, q: 1.0	hpf 70 hz, 0 db, q: 1.5	peak 8750 hz, - 5 db, q: 5.0
9062 ultimate	★★★★★	★★★★★	30 hz	none	none	4 ohms	treble 12500 hz, 3 db, q: 1.0	none	peak 8750 hz, - 5 db, q: 5.0
9062 ultimate *4	★★★★	★★★★★	30 hz	none	none	4 ohms	treble 12500 hz, 3 db, q: 1.0	peak 80 hz, - 2 db, q: 0.7	peak 8750 hz, - 5 db, q: 5.0

\*1 attention: please reduce the limiter by - 3 db if speakers are in single stereo mode  
 \*2 attention: only suitable for use with cerasonar speakers without backbox or frame (except 9062 ultimate)  
 \*4 bass performance with frame or backbox is lower

including  
added subwoofer

	bass performance	treble performance	high pass filter	low pass filter	limiter (cs-500dsp4)	impedance (cs-500dsp4)	eq filter 1 (cs-500dsp4)	eq filter 2 (cs-500dsp4)	eq filter 3 (cs-500dsp4)
1520 fit	/*3	★	105 hz	none	- 7 db	8 ohms	treble 10000 hz, 5 db, q: 0.7	hpf 105 hz, 0 db, q: 1.5	peak 200 hz, - 5 db, q: 1.0
2525 fit *1	/*3	★★	105 hz	none	- 4 db	4 ohms	treble 10000 hz, 5 db, q: 0.7	hpf 105 hz, 0 db, q: 1.5	peak 200 hz, - 5 db, q: 1.0
4062 architect	/*3	★★★★★	105 hz	none	- 7 db	4 ohms	none	hpf 105 hz, 0 db, q: 0.7	none
4062 reference *1	/*3	★★★★	105 hz	none	- 4 db	4 ohms	treble 12500 hz, 3 db, q: 1.0	hpf 105 hz, 0 db, q: 1.5	peak 8750 hz, - 5 db, q: 5.0
6062 reference *1	/*3	★★★★	105 hz	none	- 1 db	8 ohms	treble 12500 hz, 3 db, q: 1.0	hpf 105 hz, 0 db, q: 1.5	peak 8750 hz, - 5 db, q: 5.0
4062 reference pro	/*3	★★★★★	105 hz	none	- 3 db	4 ohms	treble 12500 hz, 3 db, q: 1.0	hpf 105 hz, 0 db, q: 1.5	peak 8750 hz, - 5 db, q: 5.0
6062 reference pro *1	/*3	★★★★★	70 hz	none	- 3 db	8 ohms	treble 12500 hz, 3 db, q: 1.0	hpf 105 hz, 0 db, q: 1.5	peak 8750 hz, - 5 db, q: 5.0
12030 reference pro	/*3	★★★★★	105 hz	none	- 3 db	4 ohms	treble 12500 hz, 3 db, q: 1.0	hpf 105 hz, 0 db, q: 1.5	peak 8750 hz, - 5 db, q: 5.0
9062 ultimate	/*3	★★★★★	70 hz	none	none	4 ohms	treble 12500 hz, 3 db, q: 1.0	none	peak 8750 hz, - 5 db, q: 5.0

\*1 attention: please reduce the limiter by - 3 db if speakers are in single stereo mode  
 \*3 bass performance depends on the used subwoofer

cerasonar  
subwoofers

	subwoofer performance	high pass filter	low pass filter	limiter (cs-500dsp4)	impedance (cs-500dsp4)	eq filter 1 (cs-500dsp4)	eq filter 2 (cs-500dsp4)	eq filter 3 (cs-500dsp4)
architect sub	★★★★	30 hz	90 hz	none	4 ohms	none	lpf 90 hz, 0 db, q: 0.7	none
6062 sub	★★★	30 hz	90 hz	none	4 ohms	none	lpf 90 hz, 0 db, q: 0.7	none
6062 sub *4	★★	30 hz	90 hz	none	4 ohms	peak 90 hz, -3 db, q: 0.7	lpf 90 hz, 0 db, q: 0.7	none
10040 sub	★★★	30 hz	90 hz	none	4 ohms	none	lpf 90 hz, 0 db, q: 0.7	none
13362 sub *5	★★★★★	30 hz	90 hz	none	2x 8 ohms	none	lpf 90 hz, 0 db, q: 0.7	none

\*4 bass performance with frame or backbox is lower  
 \*5 the use of the 13362 sub requires a cs-500dsp4. for use, all four channels are bridged - two cables are necessary for wiring.

**How to achieve the best sound possible - cerasonar 1520 fit**  
 The cerasonar fit series receives a significant improvement in sound quality through DSP equalisation. Operational safety is guaranteed by a high-pass filter and a power limiter. Due to a high Q of 1.5, the lower cut-off frequency is extended, so that the reproduction of the low frequencies is improved; furthermore, the coupling to a subwoofer is easier due to the lower cut-off frequency. The shelf filter in the high frequency range extends the maximum transmission to 20,000 Hz.

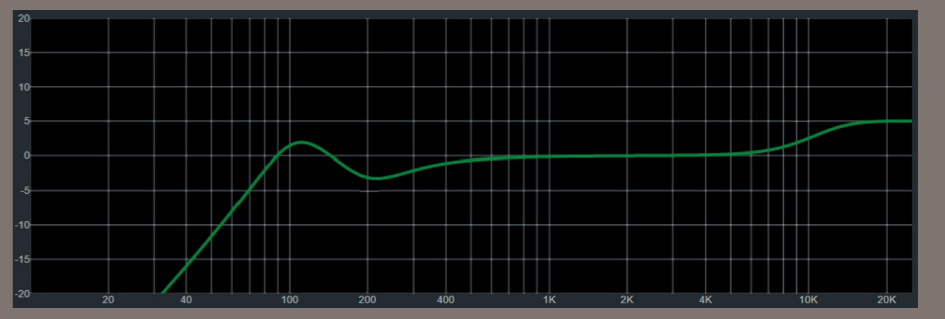

**How to achieve the best sound possible - cerasonar 13362 sub**  
 The cerasonar subwoofers are equipped without passive crossover elements. The filtering is carried out via the DSP amplifier and is essential for an optimal sound. A subsonic filter protects the drivers from excessive cone excursion and thus increases the maximum SPL. The low-pass filter ensures that the subwoofers can be smoothly coupled to the loudspeakers.

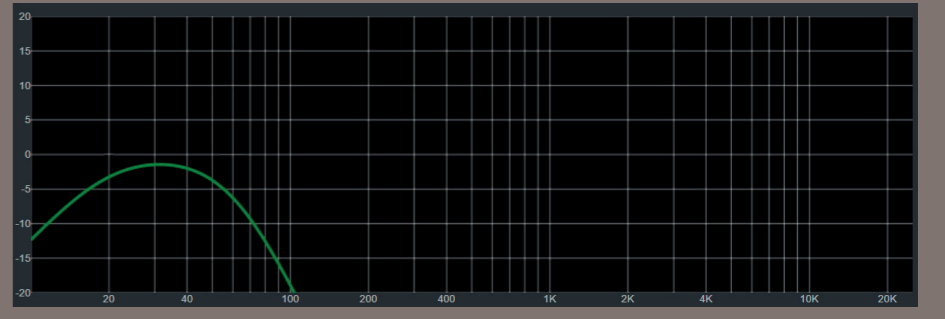

**Attention - speaker and subwoofer coupling**  
 Every installation situation is different. Especially in situations where the subwoofer and the speaker are far away from each other, a careful measurement should be carried out to guarantee a high-quality sound reproduction. The signals from the speakers and subwoofers should complement each other and produce a linear frequency response. If there is a dip in the 80 - 120 Hz (crossover frequency) region, the polarity can be changed or, if the cs-2000dsp4 is used, a delay filter can be applied to the speakers. A verification of the frequency response should be done with a measuring system - with skilled ears, a tone can also be produced at the crossover frequency.

wood panel with prepared pocket milling



speaker installed in the pocket milling

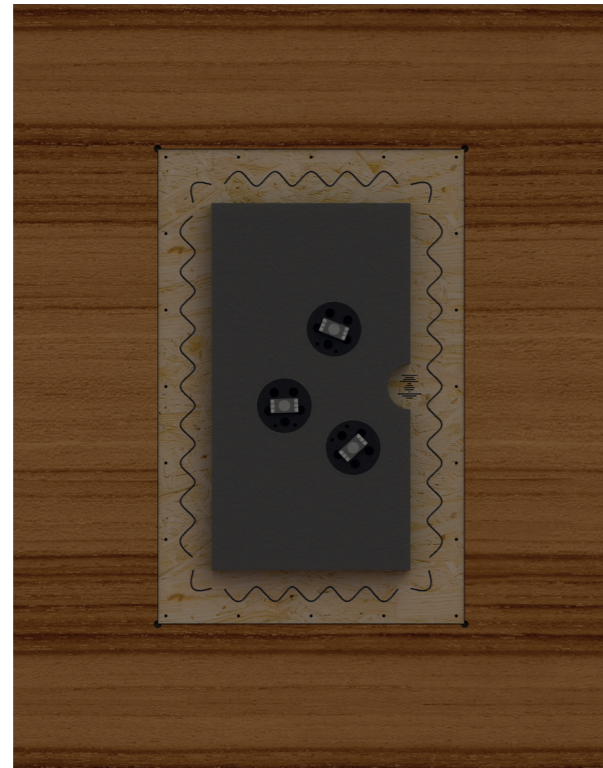

## Imagine - sound comes directly from your wooden panels

Combine all ecological, economic, biological and aesthetic advantages. Cladding walls with wood is increasingly in vogue. No wonder - wall cladding adds character, charm and personality to your property.

Nonetheless, utilising wood materials has so far always brought with it a difficult installation situation for loudspeaker systems, as each wood brings with it its unique natural characteristics. Therefore, the installation must be carried out very carefully.

Our engineering team took this as a challenge and thoroughly tested our most powerful series - the reference pro series - with different wood materials.

Using a pocket milling on the back of the panels, the reference pro series can be easily and quickly installed in any wood panel. (the excess wood should not be more than 2.5 - 3.5 mm thick)

On request, the reference pro series is supplied with our special high-performance double-sided adhesive tape, which adheres excellently to the pocket milling due to its properties.

Depending on the wood material, the resonance frequency is strongly raised and the low frequency range is reduced. Due to these natural characteristics of the wood, we recommend the use of the cerasonar architect sub and the cs-500dsp4 or cs-2000dsp4 amplifier. The latter comes with a specially developed preset for wood installations.



## How can cracks be avoided?

Like all built-in speakers, also the invisible speaker panels emit vibration noise into the adjacent areas. To ensure that no cracks occur at the butt joints, mesh tape must be applied before plastering. This kind of processing used for single-layer drywall constructions, which is mandatory according to the generally accepted rules of craftsmanship, is highly recommended also for installation work in solid walls and ceilings.

The plaster, whether decorative or non-decorative, which is applied to the panel should have a certain „flexibility“. So pure mineral plasters are not necessarily advisable. In order to minimise the risk of cracking, we recommend using products like Ardex (e.g. 828) or Knauf (Uniflott).

## Documentation of installation positions!

It is strongly recommended documenting the installation positions in the architectural plans. If at some point a defect occurs, the position of the defective panel can be accurately determined and the panel be replaced. Also future modifications to the interior design and room layout benefit from the documented positions of the speakers.

## How to prevent cases of defects?

We offer for the fit and reference series protection units that limit the max. power and protect the speakers from overload. The ultimate series already has the protection integrated. However, the max. power rating of the speaker should not be greatly exceeded by the amplifier.

## What is there to know about sound insulation?

The cerasonar panels emit structure-borne noise into the adjacent areas. It therefore is recommended – and this normally affects any builtin speaker – that the drywall shell is designed in a flexible way as it is very much common in acoustic construction. The rearward sound already is reduced by the mandatory cavity insulation. To furthermore reduce the rearward sound we offer specific backboxes.

## How long is the warranty period?

As a family business, the satisfaction of our customers has the highest priority for us. Our service includes a 5-year warranty in Germany. Our product liability insurance in cooperation with Aachen-Münchener protects against property damage and bears the full costs for a possible restoration. A prerequisite is the registration with us in our company.

## What about the durability?

If installation and operation is effected in accordance with our regulations a malfunction is almost impossible. A good example to compare is perhaps the „floor heating system“, which resembles a similar situation, and which also requires a careful execution. A trained retailer or installer meets these requirements due to the cerasonar installation and setup protocol. DIY is also possible if the manual and technical skills are given.

## Installation and setup protocol?

The installer or reseller should document all installation steps, especially the functional test and have the correct function approved and signed by the customer. The final acceptance should go together with a corresponding protocol which is to be deposited for at least 5 years with the customer and the executing firms. A copy of the protocol should also be handed over to cerasonar.

## Plaster finish instructions?

All our invisible speakers are already primed with Ardex P4. For further processing, we recommend a filler based on a gypsum-plastic base. We have tested the following plaster:

- Ardex 828
- Ardex R1
- Ardex 820 Superfinish
- Knauf Uniflott (available in most DIY stores)

(For the US market a pre mixed joint compound can be used with standard drying time)

Do not apply more than 2 mm of plaster. Less is better, otherwise the maximum volume will be affected.

In addition, mesh tape must be used for the sub and ultimate series to prevent cracking in the wall and ceiling, for all others it is optional.

We deliver the sub and ultimate with mesh tape included, anyway we can recommend the following jointtapes: Knauf Easy-Tape

## Cavity insulation?

Our invisible loudspeakers are already equipped with acoustic foam on the back. In order to guarantee perfect sound reproduction, however, the use of rockwool in the wall or ceiling cavity is indispensable. It must be ensured that there is enough space for the loudspeaker so that the insulation does not squeeze against the loudspeaker. We recommend to remove approx. 5 cm / 2 inch from the rockwool behind the loudspeaker.

## Cable selection?

We recommend to use high quality speaker cables and to pay attention to OFC or CU when selecting them. This means that the cable is 99% copper instead of copper coated aluminium. The following rule of thumb should be observed when dimensioning the cable:

4 ohms loudspeaker, e.g. cerasonar 4062 reference:

- 10 meter cable length, at least 0.75 mm<sup>2</sup> cross-section
- 20 meter cable length, at least 1.50 mm<sup>2</sup> cross-section
- 50 meter cable length, at least 4.00 mm<sup>2</sup> cross section

8 ohms loudspeaker, e.g. cerasonar 1520 fit:

- 10 meter cable length, at least 0.50 mm<sup>2</sup> cross section
- 20 meter cable length, at least 0.75 mm<sup>2</sup> cross-section
- 50 meter cable length, at least 2.50 mm<sup>2</sup> cross-section

## Vibration prevention (speaker mounting)

Our invisible loudspeakers are provided with pre-drilled holes for the screw connection. It is necessary to mount a screw in each hole in order to avoid cracking or disturbing resonances.

## Vibration prevention (cable laying)

Particularly in the ceiling (but also in the wall), care must be taken to ensure that electrical cables or similar do not touch the invisible speakers or the adjacent plasterboard. The reason for this is that the loudspeakers generate vibrations that can cause unwanted noise on the cables or other components.

To avoid this, all objects in the cavity must be secured (especially with cerasonar ultimate and sub series). We recommend routing the last meter of the speaker cable to the speaker through the mineral wool.

## Vibration prevention (ceiling and wall installations)

Similar to loudspeaker cables. We recommend that built-in devices, such as LED spots, should not be placed near the speakers. If this is not possible, we recommend installing higher quality devices, as these often have the advantage that they are not so easily prone to vibrate. If disturbing resonances should occur, the built-in devices can be damped with anti-vibration tape.

## Vibration prevention (Detection of disturbing resonances)

A tone generator, for iOS or Android, is suitable for easy detection of disturbing resonances. For this the frequency range from 20 – 20,000 Hz is swept through. In order to detect errors, the volume should be approx. 75%. The speakers must already be fixed with all screws. Especially with the cerasonar ultimate and sub series this procedure is obligatory and should not be skipped under any circumstances.

## Vibration prevention (Elimination of disturbing resonances)

First the position of the interfering resonances should be determined. With the palm of your hand you can check the wall or ceiling for „rattling noises“. After detection, an additional screwing or gluing can solve the problem. Before doing so, however, it should be checked that the rattling noise is not caused by a loose object such as an electric cable.

## Single stereo mode

For smaller rooms or for background sound, the single stereo mode is ideal. In this mode, both stereo channels (left and right) are connected to a single loudspeaker. The advantages are the saving of one loudspeaker as well as a more homogeneous sound image when used for background sound (e.g. restaurants, meeting rooms or long corridors). When the cs-500dsp4 is used, the single stereo mode is not necessary and the second speaker wire can be saved, simply use the input matrix and route the stereo input to only one speaker.

## Sound-proofing?

About sound insulation, we would like to clarify the terms relating to our loudspeakers. As the invisible loudspeaker is connected to the adjacent wall and/or ceiling surface with screws and filler transmission of structure-borne sound takes place in any case. With some cerasonar models this is even necessary since the larger area increases the frequency range in the lower region.

It is therefore highly recommended for multi-family buildings to install the invisible loudspeakers in a decoupled level – for example in a suspended ceiling.

With a separate wall construction, the sound remains in the music zone:

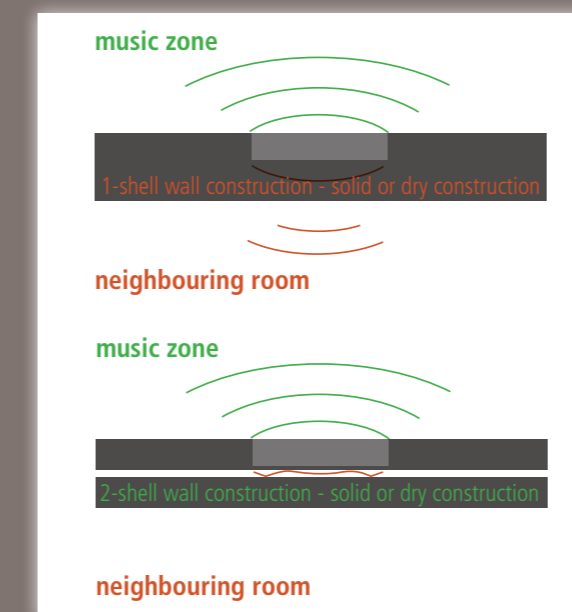





cerasonar

Ceratec Audio Design GmbH  
Headquarters  
Straubingerstrasse 5  
28219 Bremen  
Germany

Production  
Walter-Bertelsmann-Weg 2  
27726 Worpswede  
Germany

phone: +49 4791 95570 80  
e-mail: [info@cerasonar.de](mailto:info@cerasonar.de)  
web: [www.cerasonar.de](http://www.cerasonar.de)